



Серия

РЕШЕБНИК

ТОЛЬКО ДЛЯ РОДИТЕЛЕЙ

NEW

Домашняя работа по алгебре

«АЛГЕБРА И НАЧАЛА МАТЕМАТИЧЕСКОГО АНАЛИЗА

10

10 – 11 классы. Задачник»

А.Т. Мордкович



А.А. Сапожников

**Домашняя работа
по алгебре и началам
математического анализа
за 10 класс**

**к задачнику «Алгебра и начала
математического анализа. 10–11 классы.**

**В 2 ч. Ч. 2. Задачник для учащихся
общеобразовательных учреждений (базовый уровень) /
[А.Г. Мордкович и др.]; под ред. А.Г. Мордковича. —
10-е изд., стер. — М.: Мнемозина, 2009»**

Учебно-методическое пособие

Издание десятое, переработанное и исправленное

**Издательство
«ЭКЗАМЕН»**

**МОСКВА
2010**

УДК 373:[512+517]

ББК 22.14я721

С19

Имя автора и название цитируемого издания указаны на титульном листе данной книги (ст. 1274 п. 1 части четвертой Гражданского кодекса Российской Федерации).

Условия заданий и упражнений приводятся исключительно в учебных целях и в необходимом объеме — как иллюстративный материал.

Изображения учебных изданий «Алгебра и начала математического анализа. 10–11 классы. В 2 ч. Ч. 1. Учебник для учащихся общеобразовательных учреждений (базовый уровень) / А.Г. Мордкович. — 10-е изд., стер. — М.: Мнемозина, 2009» и «Алгебра и начала математического анализа. 10–11 классы. В 2 ч. Ч. 2. Задачник для учащихся общеобразовательных учреждений (базовый уровень) / [А.Г. Мордкович и др.]; под ред. А.Г. Мордковича. — 10-е изд., стер. — М.: Мнемозина, 2009» приведены на обложке данного издания исключительно в качестве иллюстративного материала (ст. 1274 п. 1 части четвертой Гражданского кодекса Российской Федерации).

Сапожников, А.А.

С19 Домашняя работа по алгебре и началам математического анализа за 10 класс к задачнику А.Г. Мордковича и др. «Алгебра и начала математического анализа. 10–11 классы. Задачник для учащихся общеобразовательных учреждений»: учебно-методическое пособие / А.А. Сапожников. — 10-е изд., перераб. и испр. — М.: Издательство «Экзамен», 2010. — 221, [3] с. (Серия «Решebник»)

ISBN 978-5-377-03007-2

В пособии решены и в большинстве случаев подробно разобраны задачи и упражнения из задачника «Алгебра и начала математического анализа. 10–11 классы. В 2 ч. Ч. 2. Задачник для учащихся общеобразовательных учреждений (базовый уровень) / [А.Г. Мордкович и др.]; под ред. А.Г. Мордковича. — 10-е изд., стер. — М.: Мнемозина, 2009».

Пособие адресовано родителям, которые смогут проконтролировать правильность решения, а в случае необходимости помочь детям в выполнении домашней работы по алгебре и началам математического анализа.

УДК 373:[512+517]

ББК 22.14я721

Формат 84х108/32. Гарнитура «Таймс». Бумага газетная.

Уч.-изд. л. 6,84. Усл. печ. л. 11,76. Тираж 20 000 экз. Заказ № 10561.

ISBN 978-5-377-03007-2

© Сапожников А.А., 2010

© Издательство «ЭКЗАМЕН», 2010

Оглавление

Глава 1. Числовые функции

§ 1. Определение числовой функции и способы ее задания.....	5
§ 2. Свойства функции.....	13
§ 3. Обратная функция.....	18

Глава 2. Тригонометрические функции

§ 4. Числовая окружность.....	22
§ 5. Числовая окружность на координатной плоскости.....	25
§ 6. Синус и косинус. Тангенс и котангенс.....	27
§ 7. Тригонометрические функции числового аргумента.....	33
§ 8. Тригонометрические функции углового аргумента.....	38
§ 9. Формулы приведения.....	40
§ 10. Функция $y = \sin x$, её свойства и график.....	42
§ 11. Функция $y = \cos x$, её свойства и график.....	46
§ 12. Периодичность функций $y = \sin x$, $y = \cos x$	50
§ 13. Преобразования графиков тригонометрических функций.....	51
§ 14. Функции $y = \operatorname{tg} x$, $y = \operatorname{ctg} x$, их свойства и графики.....	58

Глава 3. Тригонометрические уравнения

§ 15. Арккосинус. Решение уравнения $\cos t = a$	61
§ 16. Арксинус. Решение уравнения $\sin t = a$	66
§ 17. Арктангенс и арккотангенс. Решение уравнений $\operatorname{tg} x = a$, $\operatorname{ctg} x = a$	70
§ 18. Тригонометрические уравнения.....	72

Глава 4. Преобразование тригонометрических выражений

§ 19. Синус и косинус суммы и разности аргументов.....	84
§ 20. Тангенс суммы и разности аргументов.....	90
§ 21. Формулы двойного угла.....	94
§ 22. Преобразование сумм тригонометрических функций в произведения.....	104
§ 23. Преобразование произведения тригонометрических функций в суммы.....	116

Глава 5. Производная

§ 24. Предел последовательности.....	122
§ 25. Сумма бесконечной геометрической прогрессии.....	126
§ 26. Предел функции.....	131
§ 27. Определение производной.....	138
§ 28. Вычисление производных.....	140
§ 29. Уравнение касательной к графику функции.....	152

§ 30. Применение производной исследования функций на монотонность и экстремумы	158
§ 31. Построение графиков функций	164
§ 32. Применение производной для нахождения наибольших и наименьших значений.....	176
Глава 6. Степени и корни. Степенные функции	
§ 33. Понятие корня n -й степени действительного числа	189
§ 34. Функции $y = \sqrt[n]{x}$, их свойства и графики	191
§ 35. Свойства корня n -й степени	198
§ 36. Преобразование выражений, содержащих радикалы	201
§ 37. Обобщение понятия о показателе степени	206
§ 38. Степенные функции, их свойства и графики	210

Глава 1. Числовые функции

§ 1. Определение числовой функции и способы ее задания

1.1. а) $y = 3 - \frac{3}{4}x$

б) $y = \frac{-7}{2x+1}$

в) $y = \frac{5}{6}x - \frac{1}{6}$

г) $y = \frac{9}{3x^2+4x}$

1.2. а) $f(1) = 1^3 - 5 \cdot 1^2 + 7 = 3$

в) $f(-2) = (-2)^3 - 5 \cdot (-2)^2 + 7 = -21$

б) $f(3) = 3^3 - 5 \cdot 3^2 + 7 = -11$

г) $f(1,5) = \left(\frac{3}{2}\right)^3 - 5 \cdot \left(\frac{3}{2}\right)^2 + 7 = -\frac{7}{8}$

1.3. а) $f(x-2) = \frac{2(x-2)^2 + 3(x-2) - 4}{3(x-2) + 3} = \frac{2x^2 - 8x + 8 + 3x - 6 - 4}{3x - 6 + 3} =$
 $= \frac{2x^2 - 5x - 2}{3x - 3}$

б) $f(-x^3) = \frac{3x^6 - 3x^3 - 4}{-3x^3 + 3}$

в) $f\left(\frac{1}{x}\right) = \frac{\frac{2}{x^2} + \frac{3}{x} - 4}{\frac{3}{x} + 3} = \frac{-4x^2 + 2 + 3x}{3x^2 + 3x}$

г) $f(2x^2 + 3x + 5) = \frac{2(2x^2 + 3x + 5)^2 + 3(2x^2 + 3x + 5) - 4}{3x + 3} =$
 $= \frac{8x^4 + 24x^3 + 64x^2 + 69x + 61}{6x^2 + 9x + 18}$

1.4. а) $5x + 3 \neq 0 \Rightarrow x \neq -0,6$

в) $2x - 4 \neq 0 \Rightarrow x \neq 2$

б) $x^2 - 16 \neq 0 \Rightarrow x \neq \pm 4$

г) $25 - x^2 \neq 0 \Rightarrow x \neq \pm 5$

1.5. а) $x^2 - 3x + 2 \geq 0;$

$x^2 - 3x + 2 = 0.$

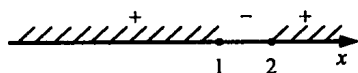

По теореме Виета: $x_1 = 1, x_2 = 2.$

Тогда $x^2 - 3x + 2 \geq 0 \Leftrightarrow x \in (-\infty; 1] \cup [2; +\infty)$

б) $x^2 - 4 > 0 \Leftrightarrow |x| > 2 \Leftrightarrow x \in (-\infty; -2) \cup (2; +\infty)$

в) $x^2 + 4x - 12 \geq 0;$

$x^2 + 4x - 12 = 0.$

По теореме Виета:

$$x_1 = -6, x_2 = 2.$$

Тогда

$$x^2 + 4x - 12 \geq 0 \Leftrightarrow x \in (-\infty; -6] \cup [2; +\infty)$$

$$r) 49 - x^2 > 0 \Leftrightarrow |x| < 7 \Leftrightarrow x \in (-7; 7)$$

$$1.6. a) \begin{cases} 2x - 4 \geq 0 \\ 10 - 2,5x > 0 \end{cases} \Leftrightarrow \begin{cases} x \geq 2 \\ x < 4 \end{cases} \Leftrightarrow x \in (2; 4)$$

$$b) \begin{cases} 10x - 3x^2 - 3 \geq 0 \\ x^2 - 4 > 0 \\ 25 - 4x^2 \neq 0 \end{cases} \Leftrightarrow 10x - 3x^2 - 3 = 0$$

$$D = 100 - 36 = 64 \Rightarrow x_{1,2} = \frac{-10 \pm 9}{-6} \Rightarrow$$

$$x_1 = 3 \text{ и } x_2 = \frac{1}{3} \Leftrightarrow$$

$$\Leftrightarrow \begin{cases} \frac{1}{3} \leq x \leq 3 \\ x > 2 \\ x < -2 \\ x \neq \pm 2,5 \end{cases} \Leftrightarrow \begin{cases} 2 < x < 2,5 \\ 2,5 < x \leq 3 \end{cases}$$

$$b) \begin{cases} 2x^2 - 5x + 2 \geq 0 \\ 10 - 2x > 0 \end{cases} \Leftrightarrow \begin{cases} x \leq \frac{1}{2} \\ x \geq 2 \\ x < 5 \end{cases} \Leftrightarrow$$

$$\Leftrightarrow \begin{cases} x \leq \frac{1}{2} \\ 2 \leq x < 5 \end{cases};$$

$$2x^2 - 5x + 2 = 0$$

$$D = 25 - 16 = 9 \Rightarrow x_{1,2} = \frac{5 \pm 3}{4} \Rightarrow x_1 = 2 \text{ и } x_2 = \frac{1}{2}$$

$$r) \begin{cases} x^2 - 36 \geq 0 \\ 11x - x^2 - 10 > 0 \\ x^4 - 2401 \neq 0 \end{cases} \Leftrightarrow \begin{cases} |x| \geq 6 \\ 1 < x < 10 \\ x \neq \pm 7 \end{cases} \Leftrightarrow$$

$$\Leftrightarrow \begin{cases} 6 \leq x < 7 \\ 7 < x < 10 \end{cases}$$

$$x^2 - 11x + 10 = 0.$$

По теореме Виета: $x_1 = 1$ и $x_2 = 10$.

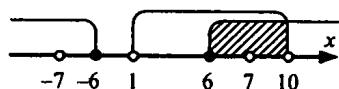
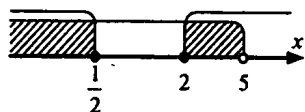
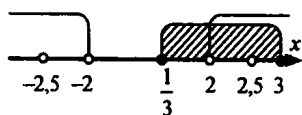
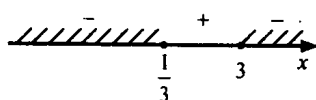
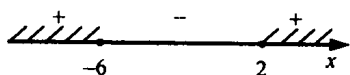

1.7. a) $y = 2x - 3$;

$D(f) = \mathbb{R}$; $E(f) = \mathbb{R}$

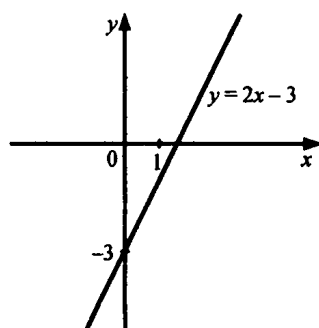

б) $y = 6 - 3x$;

$D(f) = \mathbb{R}$; $E(f) = \mathbb{R}$

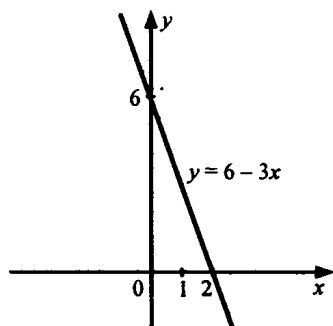

в) $y = \frac{x}{2} + 4$;

$D(f) = \mathbb{R}$; $E(f) = \mathbb{R}$

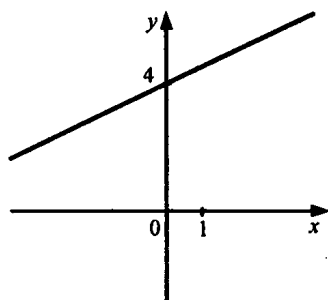

г) $y = -\frac{2x}{3} - 3$;

$D(f) = \mathbb{R}$; $E(f) = \mathbb{R}$

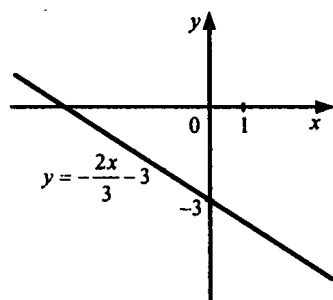

1.8. a) $y = x^2 + 2$;

$D(f) = \mathbb{R}$, $E(f) = [2; +\infty)$

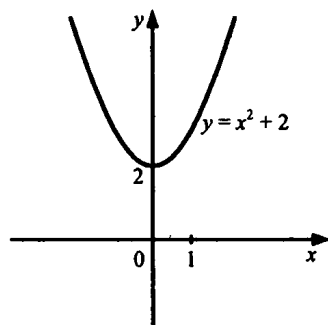

б) $y = 3 - 2x^2$;

$D(f) = \mathbb{R}$, $E(f) = (-\infty; 3]$

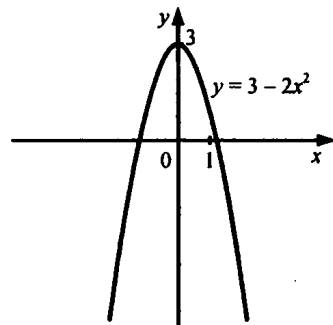

$$b) y = \frac{1}{2}x^2 - 4;$$

$$D(f) = \mathbb{R}, E(f) = [-4; +\infty)$$

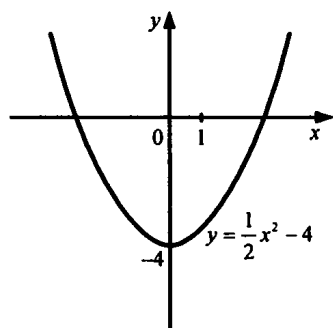

$$r) y = -1,5x^2 - 2;$$

$$D(f) = \mathbb{R}, E(f) = (-\infty; -2]$$

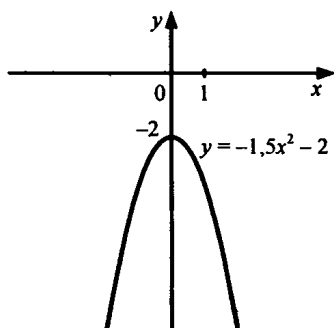

$$1.9. a) y = \sqrt{x};$$

$$D(f) = [0; +\infty), E(f) = (0; +\infty)$$

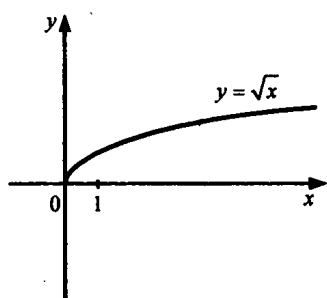

$$b) y = -\sqrt{x};$$

$$D(f) = (0; +\infty), E(f) = (-\infty; 0]$$

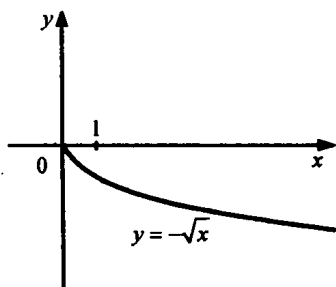

$$6) y = \sqrt{x-3};$$

$$D(f) = [3; +\infty), E(f) = [0; +\infty)$$

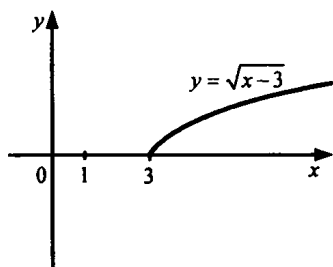

$$r) y = -\sqrt{x} + 2;$$

$$D(f) = (0; +\infty), E(f) = (-\infty; 2]$$

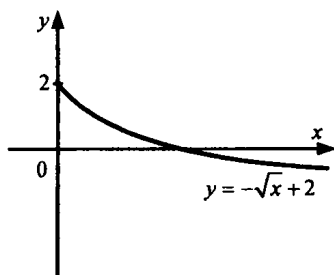

1.10. a) $y = x^2 + 3x - 28 =$
 $= (x + 1,5)^2 - 30,25$
 $D(f) = \mathbb{R} ; E(f) = (-30,25; +\infty)$

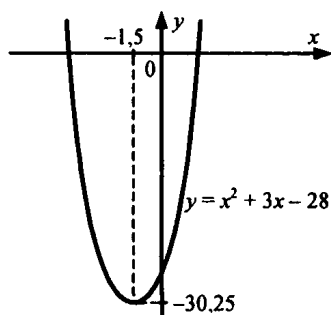

1.11. a) $y = \frac{1}{x} + 3;$
 $D(f) = (-\infty; 0) \cup (0; +\infty)$
 $E(f) = (-\infty; 3) \cup (3; +\infty)$

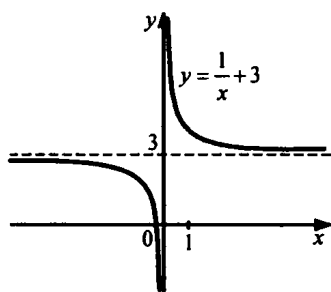

b) $y = \frac{-2}{x} - 1;$
 $D(f) = (-\infty; 0) \cup (0; +\infty)$
 $E(f) = (-\infty; -1) \cup (-1; +\infty)$

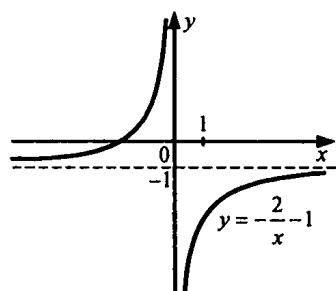

б) $y = -x^2 - 2x + 24 =$
 $= -(x + 1)^2 + 25$
 $D(f) = \mathbb{R} ; E(f) = (-\infty; 25]$

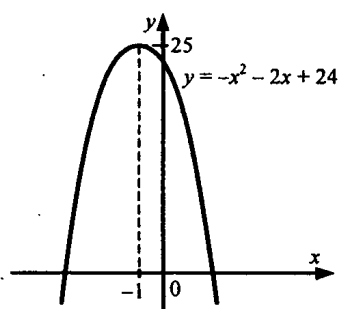

б) $y = \frac{5}{x+3};$
 $D(f) = (-\infty; -3) \cup (-3; +\infty)$
 $E(f) = (-\infty; 0) \cup (0; +\infty)$

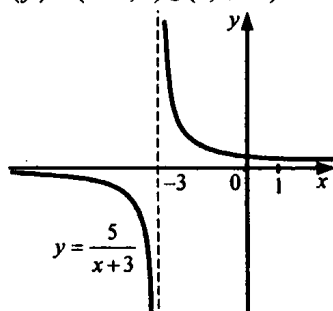

г) $y = \frac{4}{1-x};$
 $D(f) = (-\infty; 1) \cup (1; +\infty)$
 $E(f) = (-\infty; 0) \cup (0; +\infty)$

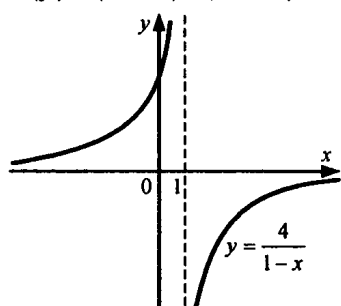

1.12. а) $y = |x|$;
 $D(f) = \mathbb{R}$, $E(f) = (0; +\infty)$

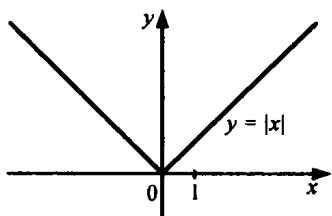

б) $y = |x - 2|$;
 $D(f) = \mathbb{R}$, $E(f) = (0; +\infty)$

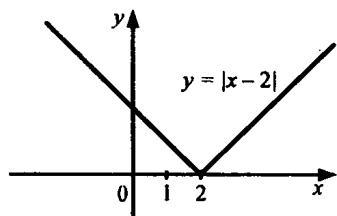

в) $y = -|x|$;
 $D(f) = \mathbb{R}$, $E(f) = (-\infty; 0]$

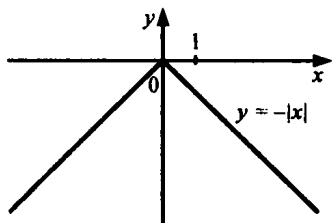

г) $y = 3 - |x|$;
 $D(f) = \mathbb{R}$, $E(f) = (-\infty; 3]$

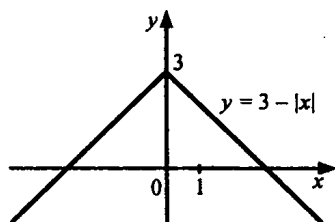

1.13. а) $y = \frac{1}{16x^2 - 49}$

$$D(f) = \{x \mid 16x^2 - 49 \neq 0\} = \left(-\infty; -\frac{7}{4}\right) \cup \left(\frac{7}{4}; +\infty\right)$$

$$E(16x^2 - 49) = [-49; +\infty) \Rightarrow E(f) = \left(-\infty; -\frac{1}{49}\right) \cup (0; +\infty)$$

б) $y = \sqrt{x^2 + 4x + 3}$

$$D(f) = \{x \mid x^2 + 4x + 3 \geq 0\} = (-\infty; -3] \cup [-1; +\infty)$$

$x^2 + 4x + 3 = 0$. По теореме Виета: $x_1 = -1$, $x_2 = -3$.

$$E(f) = [0; +\infty)$$

в) $y = \frac{1}{9 - 25x^2}$

$$D(f) = \{x \mid 9 - 25x^2 \neq 0\} = \left(-\infty; -\frac{3}{5}\right) \cup \left(\frac{3}{5}; +\infty\right)$$

$$E(9 - 25x^2) = (-\infty; 9) \Rightarrow (-\infty; 0) \cup \left[\frac{1}{9}; +\infty\right)$$

$$r) y = \sqrt{3x - x^2 + 18}$$

$$D(f) = \{x \mid 3x - x^2 + 18 \geq 0\} = [-3; 6]$$

$$3x - x^2 + 18 = 0. \text{ По теореме Виета: } x_1 = 6, x_2 = -3.$$

$$E(f) = \{y \mid y = \sqrt{3x - x^2 + 18}; -3 \leq x \leq 6\} = [0; 4,5]$$

$$1.14. a) y = f(-x)$$

$$б) y = -f(x)$$

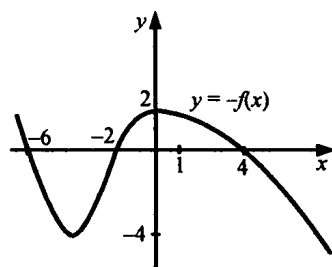
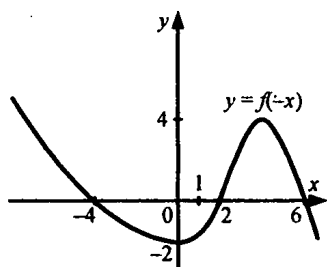

$$в) y = -f(-x)$$

$$г) y = f(x-1) + 2$$

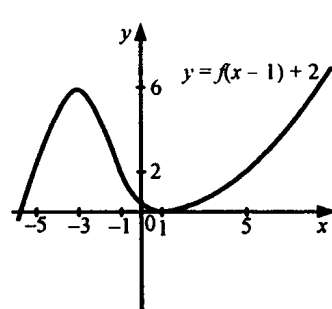
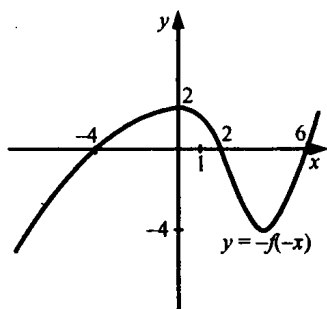

$$1.15: a) y = f(|x|) = x^2 - 4|x| + 3$$

$$б) y = |f(x)| = |x^2 - 4x + 3|$$

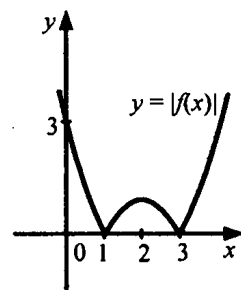
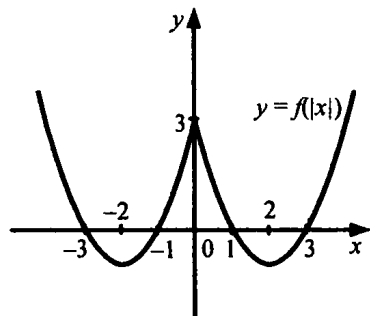

$$в) y = |f(|x|)| = |x^2 - 4|x| + 3|$$

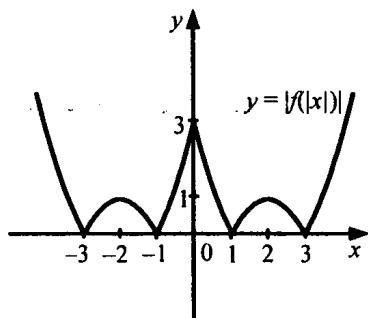

$$г) y = -|f(|x|)| = -|x^2 - 4|x| + 3|$$

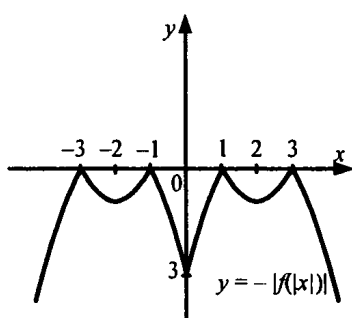

1.16.

а)

$$x^3 = 3 - 2x.$$

Построим графики обеих частей

$$y = x^3 \text{ и } y = 3 - 2x$$

Точка пересечения $(1; 1) \Rightarrow x = 1.$

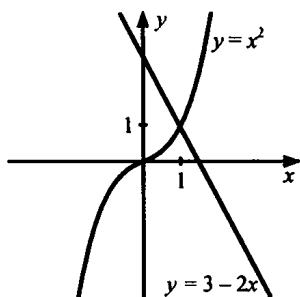

б)

$$\sqrt{x} = 2x - 6.$$

Построим графики обеих частей:

$$y = \sqrt{x} \text{ и } y = 2x - 6.$$

Точка пересечения $(4; 2) \Rightarrow x = 4.$

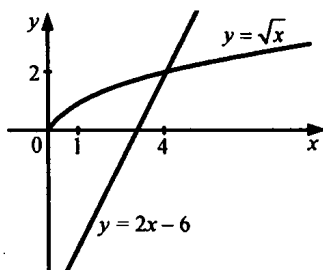

в)

$$|x - 2| = \frac{3}{x}.$$

Построим графики обеих частей:

$$y = |x - 2| \text{ и } y = \frac{3}{x}.$$

Точка пересечения $(3; 1) \Rightarrow x = 3.$

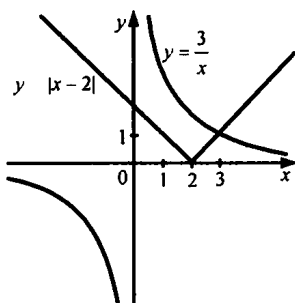

г)
 $x^{-2} = 5x - 4$.

Построим графики обеих частей:

$y = x^{-2}$ и $y = 5x - 4$.

Точка пересечения $(1; 1) \Rightarrow x = 1$.

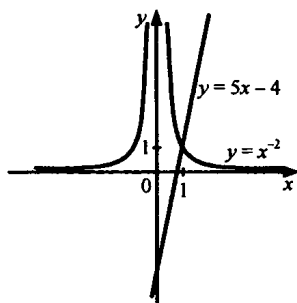

1.17. а) $f\left(\frac{1}{4}\right) = 5$ б) $f(\sqrt{2}) = 1$

в) $f\left(1\frac{1}{6}\right) = 6$ г) $f\left((\sqrt{5})^2\right) = 0$

1.18.

а) $f(6,25) = 2,5$;

$f(0,01) = 100$;

$f(-3)$ не определено

в) $D(f) = (0; +\infty)$;

г) $E(f) = [1; +\infty)$

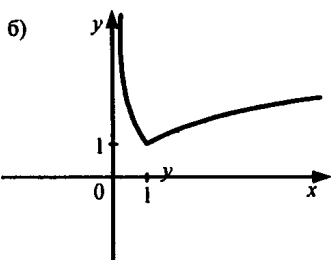

1.19.

а) $f(-5)$ — не определено;

$f(-3) = 2$; $f(0) = 5$;

$f(4) = \frac{1}{2}$.

в) $D(f) = [-4; +\infty)$;

г) $E(f) = (0; 5]$

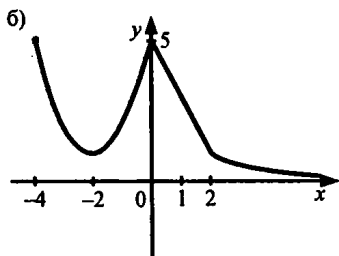

§ 2. Свойства функции

2.1. а) $y = 8x + 3$;

$x_1 < x_2 \Rightarrow 8x_1 + 3 < 8x_2 + 3 \Rightarrow y_1 < y_2 \Rightarrow$ функция возрастает.

б) $y = 5 - 2x$;

$x_1 < x_2 \Rightarrow 5 - 2x_1 < 5 - 2x_2 \Rightarrow y_1 > y_2 \Rightarrow$ функция убывает.

в) $y = \frac{x}{3} + 1$;

$x_1 < x_2 \Rightarrow \frac{x_1}{3} + 1 < \frac{x_2}{3} + 1 \Rightarrow y_1 < y_2 \Rightarrow$ функция возрастает.

$$\Gamma) y = \frac{1}{3} - \frac{2x}{5};$$

$$x_1 < x_2 \Rightarrow \frac{1}{3} - \frac{2x_1}{5} > \frac{1}{3} - \frac{2x_2}{5} \Rightarrow y_1 > y_2 \Rightarrow \text{функция убывает.}$$

$$2.2. \text{ а) } y = 2x^3 - 3;$$

$$x_1 < x_2 \Rightarrow x_1^3 < x_2^3 \Rightarrow 2x_1^3 - 3 < 2x_2^3 - 3 \Rightarrow y_1 < y_2 \Rightarrow \text{функция возрастает.}$$

$$\text{б) } y = 7 - \frac{x^3}{2};$$

$$x_1 < x_2 \Rightarrow x_1^3 < x_2^3 \Rightarrow 7 - \frac{x_1^3}{2} > 7 - \frac{x_2^3}{2} \Rightarrow y_1 > y_2 \Rightarrow \text{функция убывает.}$$

$$\text{в) } y = \frac{2}{3} - x^3;$$

$$x_1 < x_2 \Rightarrow x_1^3 < x_2^3 \Rightarrow \frac{2}{3} - x_1^3 > \frac{2}{3} - x_2^3 \Rightarrow y_1 > y_2 \Rightarrow \text{функция убывает.}$$

$$\Gamma) y = 4 + x^3;$$

$$x_1 < x_2 \Rightarrow x_1^3 < x_2^3 \Rightarrow 4 + x_1^3 < 4 + x_2^3 \Rightarrow y_1 < y_2 \Rightarrow \text{функция возрастает.}$$

$$2.3. \text{ а) } y = x^2 + 2x + 1, x \geq -1;$$

$$y = x^2 + 2x + 1 = (x+1)^2;$$

$$-1 \leq x_1 < x_2 \Rightarrow 0 \leq x_1 + 1 < x_2 + 1 \Rightarrow$$

$$(x_1 + 1)^2 < (x_2 + 1)^2 \Rightarrow y_1 < y_2 \Rightarrow \text{функция возрастает.}$$

$$\text{б) } y = \frac{1}{x+2}, x < -2;$$

$$x_1 < x_2 < -2 \Rightarrow x_1 + 2 < x_2 + 2 < 0 \Rightarrow$$

$$\frac{1}{x_1 + 2} > \frac{1}{x_2 + 2} \Rightarrow y_1 > y_2 \Rightarrow \text{функция убывает.}$$

$$\text{в) } y = -x^2 + 6x - 12, x \geq 3;$$

$$y = -x^2 + 6x - 12 = -(x-3)^2 - 3$$

$$3 \leq x_1 < x_2 \Rightarrow 0 \leq x_1 - 3 < x_2 - 3 \Rightarrow (x_1 - 3)^2 < (x_2 - 3)^2 \Rightarrow$$

$$-(x_1 - 3)^2 - 3 > -(x_2 - 3)^2 - 3 \Rightarrow y_1 > y_2 \Rightarrow \text{функция убывает.}$$

$$\Gamma) y = \frac{-2}{x+5}, x > -5;$$

$$-5 < x_1 < x_2 \Rightarrow 0 < x_1 + 5 < x_2 + 5 \Rightarrow$$

$$\frac{1}{x_1 + 5} > \frac{1}{x_2 + 5} \Rightarrow \frac{-2}{x_1 + 5} < \frac{-2}{x_2 + 5} \Rightarrow y_1 < y_2 \Rightarrow \text{функция возрастает.}$$

$$2.4. \text{ а) } y = x^3 + 2x;$$

$$x_1 < x_2 \Rightarrow x_1^3 < x_2^3 \Rightarrow x_1^3 + 2x_1 < x_2^3 + 2x_2 \Rightarrow y_1 < y_2 \Rightarrow \text{функция возрастает.}$$

$$\text{б) } y = 5 - x^3 - 6x^9;$$

$x_1 < x_2 \Rightarrow x_1^3 < x_2^3$ и $x_1^9 < x_2^9 \Rightarrow 5 - x_1^3 - 6x_1^9 > 5 - x_2^3 - 6x_2^9 \Rightarrow y_1 > y_2 \Rightarrow$
 функция убывает.

$$\text{в) } y = 4 - x^5$$

$x_1 < x_2 \Rightarrow x_1^5 < x_2^5 \Rightarrow 4 - x_1^5 > 4 - x_2^5 \Rightarrow y_1 > y_2 \Rightarrow$ функция убывает

$$\text{г) } y = x^7 + x^5 - 3$$

$x_1 < x_2 \Rightarrow x_1^7 < x_2^7$ и $x_1^5 < x_2^5 \Rightarrow x_1^7 + x_1^5 - 3 < x_2^7 + x_2^5 - 3 \Rightarrow y_1 < y_2 \Rightarrow$
 функция возрастает.

$$\text{2.5. а) } y = \sqrt{x^2 + 1}$$

$-1 \leq x_1 < x_2 \Rightarrow -1 \leq x_1^3 < x_2^3 \Rightarrow 0 \leq x_1^3 + 1 < x_2^3 + 1 \Rightarrow$

$\Rightarrow \sqrt{x_1^3 + 1} < \sqrt{x_2^3 + 1} \Rightarrow y_1 < y_2 \Rightarrow$ функция возрастает.

$$\text{б) } y = 5 - x^5 - \sqrt{2x^3}$$

$0 \leq x_1 < x_2 \Rightarrow x_1^5 < x_2^5$ и $\sqrt{2x_1^3} < \sqrt{2x_2^3} \Rightarrow 5 - x_1^5 - \sqrt{2x_1^3} > 5 - x_2^5 - \sqrt{2x_2^3} \Rightarrow$
 $y_1 > y_2 \Rightarrow$ функция убывает.

$$\text{в) } y = 2 - \sqrt{x};$$

$0 \leq x_1 < x_2 \Rightarrow \sqrt{x_1} < \sqrt{x_2} \Rightarrow 2 - \sqrt{x_1} > 2 - \sqrt{x_2} \Rightarrow y_1 > y_2 \Rightarrow$ функция
 убывает.

$$\text{г) } y = \sqrt{x^7} + x - 1;$$

$0 \leq x_1 < x_2 \Rightarrow \sqrt{x_1^7} < \sqrt{x_2^7} \Rightarrow \sqrt{x_1^7} + x_1 - 1 < \sqrt{x_2^7} + x_2 - 1 \Rightarrow y_1 < y_2 \Rightarrow$
 функция возрастает.

2.6. а) $y = x^2 - 8x + 1 = (x - 4)^2 - 15 \geq -15 \Rightarrow$ функция ограничена снизу.

б) $y = \frac{2x - 4}{x} = 2 - \frac{4}{x} < 2 \Rightarrow$ функция ограничена сверху.

в) $y = -2x^2 - 6x + 15 = -2\left(x + \frac{3}{2}\right)^2 + 19,5 \leq 19,5 \Rightarrow$ функция ограничена
 сверху.

г) $y = \frac{5 - 2x}{1 - x} = \frac{3}{1 - x} + 2 > 2 \Rightarrow$ функция ограничена снизу.

$x < 1 \Rightarrow 1 - x > 0 \Rightarrow \frac{1}{1 - x} > 0.$

2.7. а) $y = \sqrt{-x^2 + 4x - 5} = \sqrt{-(x - 2)^2 - 1}; -(x - 2)^2 - 1 < 0 \Rightarrow$ функция
 нигде не ограничена.

б) $y = \sqrt{\frac{x^2 - 4x + 1}{5}} = \frac{1}{\sqrt{5}} \sqrt{(x - 2)^2 - 3} \geq 0 \Rightarrow$ функция ограничена снизу.

в) $y = \sqrt{-2x^2 + 8x + 9} = \sqrt{-2(x-2)^2 + 17} \geq 0 \Rightarrow$ функция ограничена снизу.

$17 - 2(x-2)^2 \leq 17 \Rightarrow y = \sqrt{17 - 2(x-2)^2} \leq \sqrt{17} \Rightarrow$ функция ограничена сверху.

г) $\sqrt{\frac{5}{2x^2 - 4x + 2}} = \sqrt{\frac{5}{2(x-1)^2}} = \frac{\sqrt{5}}{\sqrt{2}|x-1|} > 0 \Rightarrow$ функция ограничена снизу.

2.8. а) $y = 3 - 2x, x \in (-1; 3]$;

$$-1 \leq x \leq 3 \Rightarrow -6 \leq -2x \leq 2 \Rightarrow -3 \leq 3 - 2x \leq 5 \Rightarrow y_{\text{наиб}} = 5, y_{\text{наим}} = -3.$$

б) $y = -2x^2 + 2x, x \in [-3; 2]$;

$$y = -2x^2 + 2x = -2\left(x - \frac{1}{2}\right)^2 + \frac{1}{2} \leq \frac{1}{2} \Rightarrow y_{\text{наиб}} = \frac{1}{2}$$

$$y(-3) = -24, y(2) = -4 \Rightarrow y_{\text{наиб}} = -4$$

в) $y = 3 - 4x, x \in (-\infty; 3]$;

$$x \leq 3 \Rightarrow -4x \geq -12 \Rightarrow 3 - 4x \geq -9 \Rightarrow y \geq -9 \Rightarrow$$

$y_{\text{наиб}} = -9$; $y_{\text{наим}}$ не существует.

г) $y = x^2 + 4x + 5, x \in (0; 1]$;

$$y = x^2 + 4x + 5 = (x+2)^2 + 1 \geq 1 \Rightarrow y_{\text{наим}} = 1;$$

y — возрастает на $(0; 1]$ $\Rightarrow y_{\text{наиб}} = y(1) = 10$

2.9. а) $y = \sqrt{x}, x \in (2; +\infty)$;

$$x \geq 2 \Rightarrow y = \sqrt{x} \geq \sqrt{2} \Rightarrow y_{\text{наим}} = \sqrt{2}; y_{\text{наиб}} \text{ не существует.}$$

б) $y = -\sqrt{x}, x \in [1; 9]$;

y — убывающая функция $\Rightarrow y_{\text{наиб}} = y(1) = -1; y_{\text{наим}} = y(9) = -3$

в) $y = \sqrt{x}, x \in [1,44; 6,25]$;

$$1,44 \leq x \leq 6,25 \Rightarrow 1,2 \leq y = \sqrt{x} \leq 2,5 \Rightarrow y_{\text{наим}} = 1,2; y_{\text{наиб}} = 2,5$$

г) $y = -\sqrt{x}, x \in (0; 1,69]$;

$$0 < x \leq 1,69 \Rightarrow -1,3 \leq y = -\sqrt{x} < 0 \Rightarrow$$

$\Rightarrow y_{\text{наим}} = -1,3; y_{\text{наиб}}$ не существует.

2.10. а) $y = 2|x| - 1, x \in (-3; 2]$;

$$-3 \leq x \leq 2 \Rightarrow 0 \leq |x| \leq 3 \Rightarrow -1 \leq y = 2|x| - 1 \leq 5 \Rightarrow y_{\text{наиб}} = 5; y_{\text{наим}} = -1$$

б) $y = 3 - |2x|, x \in (-5; 4]$;

$$-5 < x \leq 4 \Rightarrow -10 < 2x \leq 8 \Rightarrow 0 \leq |2x| < 10 \Rightarrow -7 < y = 3 - |2x| \leq 3 \Rightarrow$$

$y_{\text{наиб}} = 3, y_{\text{наим}}$ не существует.

в) $y = 1,5 - |5x|, x \in [-8; 2];$

$-8 \leq x \leq 2 \Rightarrow -40 \leq 5x \leq 10 \Rightarrow 0 \leq |5x| \leq 40 \Rightarrow -38,5 \leq y = 1,5 - |5x| \leq 1,5 \Rightarrow$

$y_{\text{наиб}} = 1,5; y_{\text{наим}} = -38,5$

г) $y = 6|x| - 2, x \in (-10; 4);$

$-10 \leq x < 4 \Rightarrow 0 \leq |x| \leq 10 \Rightarrow -2 \leq y = 6|x| - 2 \leq 58 \Rightarrow y_{\text{наиб}} = 58, y_{\text{наим}} = -2$

2.11. а) $y = x^2 + 2x^4 + 1;$

$y(-x) = (-x)^2 + 2(-x)^4 + 1 = x^2 + 2x^4 + 1 = y(x) \Rightarrow$ функция четная.

б) $y = \frac{x}{x^2 + 1};$

$y(-x) = \frac{-x}{(-x)^2 + 1} = -\frac{x}{x^2 + 1} = -f(x) \Rightarrow$ функция нечетная.

в) $y = \frac{-3x^2 + 1}{1 - x^4};$

$y(-x) = \frac{-3(-x)^2 + 1}{1 - (-x)^4} = \frac{-3x^2 + 1}{1 - x^4} = y(x) \Rightarrow$ функция четная.

г) $y = 5 - 3x^3;$

$y(-x) = 5 - 3(-x)^3 = 5 + 3x^3 \Rightarrow$ функция ни четная, ни нечетная.

2.12. $y = \begin{cases} \frac{3}{x}, & \text{если } x < 0 \\ 3\sqrt{x}, & \text{если } x \geq 0 \end{cases}$

1) $D(f) = \mathbb{R} = (-\infty; +\infty)$

2) Функция возрастает на $(0; +\infty)$;

функция убывает на $(-\infty; 0)$.

3) Функция не ограничена.

4) $y_{\text{наиб}}$ и $y_{\text{наим}}$ не существуют.

5) Функция непрерывна на $(-\infty; 0)$ и на $(0; +\infty)$.

В точке $x = 0$ функция имеет разрыв.

6) $E(f) = \mathbb{R} = (-\infty; +\infty)$.

2.13. $y = \begin{cases} 4 - 2x^2, & \text{если } -1 \leq x \leq 1 \\ x + 1, & \text{если } 1 < x \leq 3 \end{cases}$

1) $D(f) = (-1; 3]$

2) Функция возрастает на $[-1; 0]$ и $[1; 3]$;

функция убывает на $[0; 1]$.

3) Функция ограничена и снизу, и сверху.

4) $y_{\text{наиб}} = 4$ (достигает в $x = 0$), $y_{\text{наим}} = 2$

(достигает в $x = 1$).

5) Функция непрерывна на $[-1; 3]$. 6) $E(f) = [2; 4]$.

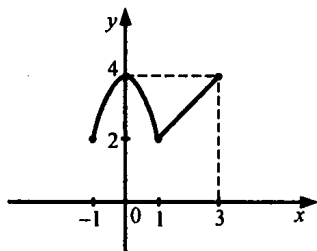
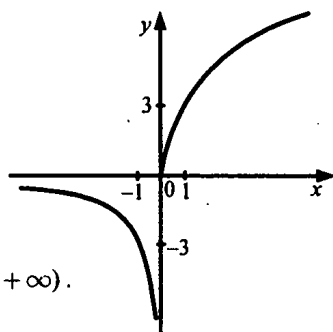

$$2.14. y = \begin{cases} 2, & \text{если } -3 \leq x \leq 0 \\ \sqrt{x} + 1, & \text{если } 1 < x \leq 4 \\ (x-5)^2 + 2, & \text{если } 4 < x \leq 6 \end{cases}$$

1) $D(f) = [-3; 0] \cup (1; 6]$

2) Функция возрастает на $(1; 4]$ и $[5; 6]$;

функция убывает на $[4; 5]$;

функция постоянна на $[-3; 0]$.

3) Функция ограничена и сверху, и снизу.

4) $y_{\text{наиб}} = 3$ (достигается в $x = 4$), $y_{\text{наим}} = 2$ (достигается в $x = 0$).

5) Функция непрерывна на $[-3; 0] \cup (1; 6]$.

6) $E(f) = [2; 3]$.

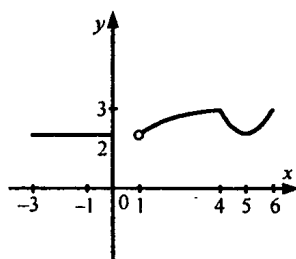

$$2.15. y = \begin{cases} x^3, & \text{если } x < 0 \\ -x^2 + 2x + 2, & \text{если } 0 \leq x \leq 2 \\ x, & \text{если } 2 < x \leq 4 \end{cases}$$

1) $D(f) = (-\infty; 4]$.

2) Функция возрастает на $(-\infty; 1]$ и $(2; 4]$.

3) Функция ограничена сверху и неограничена снизу.

4) $y_{\text{наиб}} = 4$ (достигается в $x = 4$).

5) Функция непрерывна на

$(-\infty; 0) \cup (0; 4]$. в точке $x = 0$ функция имеет разрыв.

6) $E(f) = (-\infty; 0) \cup (2; 4]$.

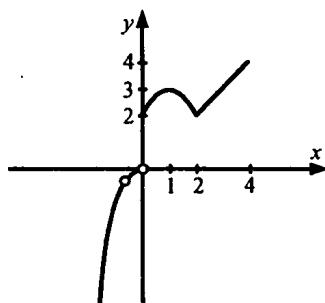

§ 3. Обратная функция

3.1. а) $y = 3x - 1 \Rightarrow x = \frac{y+1}{3} = \frac{1}{3}y + \frac{1}{3}$

в) $y = 5x + 2 \Rightarrow x = \frac{y-2}{5} = 0,2y - 0,4$

б) $y = 2 + 4x \Rightarrow x = \frac{y-2}{4} = 0,25y - 0,5$

г) $y = 3 - x \Rightarrow x = 3 - y$

3.2. а) $y = \frac{x+1}{2x-3} = \frac{1}{2} \left(\frac{2x+2}{2x-3} \right) = \frac{1}{2} \left(1 + \frac{5}{2x-3} \right)$

$$\Rightarrow 2x-3 = \frac{5}{2y-1} \Rightarrow x = \frac{1}{2} \left(3 + \frac{5}{2y-1} \right) = \frac{3y+1}{2y-1}$$

б) $y = \frac{4-3x}{1+x} = \frac{7}{1+x} - 3 \Rightarrow 1+x = \frac{7}{y+3} \Rightarrow x = \frac{y-4}{y+3}$;

$$b) y = \frac{3-2x}{5x+1} \Rightarrow 5yx + y = 3 - 2x \Rightarrow x = \frac{3-y}{5y+2}$$

$$r) y = \frac{2x-5}{1+2x} = 1 - \frac{6}{1+2x} \Rightarrow 1+2x = \frac{6}{1-y} \Rightarrow x = \frac{y+5}{2-2y}$$

$$3.3. a) y = x^2, x \geq 0 \Rightarrow x = \sqrt{y}$$

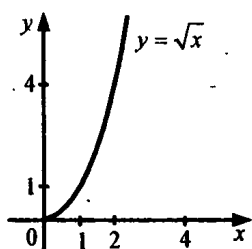
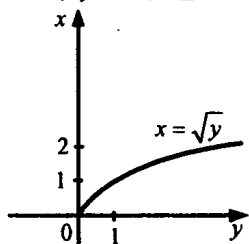

$$b) y = \sqrt{x} \Rightarrow x = y^2, y \geq 0$$

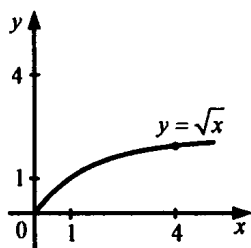
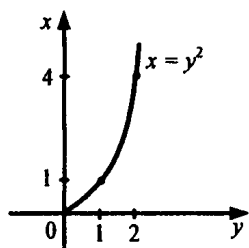

$$b) y = (x-1)^2, x \leq 1 \Rightarrow x = 1 - \sqrt{y}$$

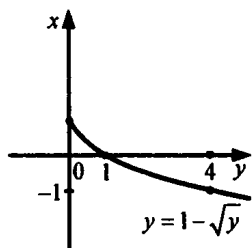
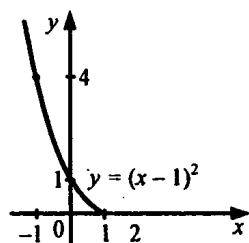

$$r) y = \sqrt{-x} \Rightarrow x = -y^2, y \geq 0$$

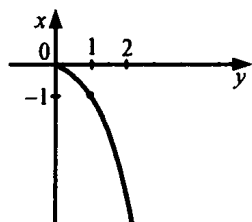
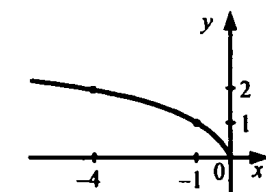

3.4. a) $y = x^3 \Rightarrow x = y^{\frac{1}{3}}$

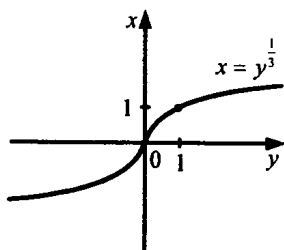
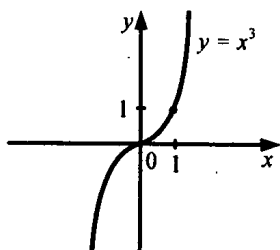

б) $y = (x-2)^3 \Rightarrow x = 2 + y^{\frac{1}{3}}$

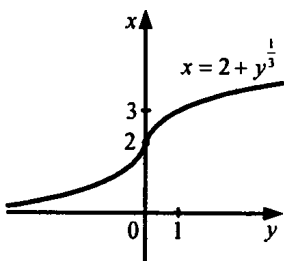
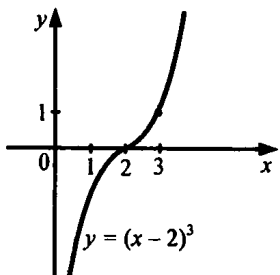

в) $y = 1 - x^3 \Rightarrow x = (1 - y)^{\frac{1}{3}}$

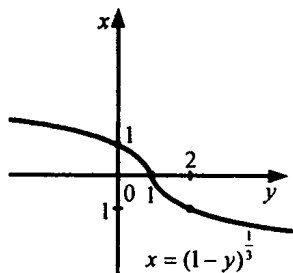
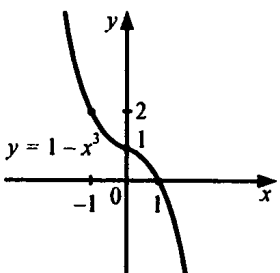

г) $y = (x+3)^3 - 1 \Rightarrow x = (y+1)^{\frac{1}{3}} - 3$

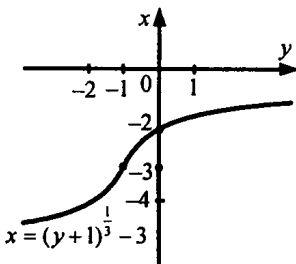
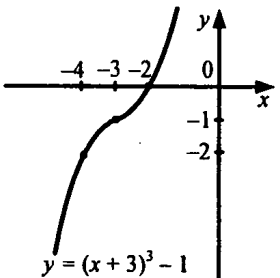

3.5.

а) $y = x^2 + 4x - 8, x \in [-3; 0]$

$$y = (x+2)^2 - 12$$

$$x \in [-2; 0] \Rightarrow x = \sqrt{y+12} - 2$$

$$x \in (-3; -1] \Rightarrow x = -\sqrt{y+12} - 2$$

\Rightarrow обратная функция не существует.

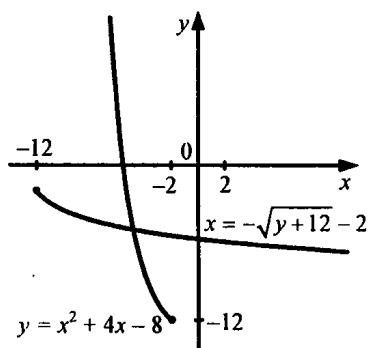

в) $y = -x^2 + 2x + 6, x \in (0; 3]$

$$y = -(x-1)^2 + 7$$

$$x \in [0; 1] \Rightarrow x = -\sqrt{7-y} + 1$$

$$x \in (1; 3] \Rightarrow x = \sqrt{7-y} + 1$$

\Rightarrow обратная функция не существует

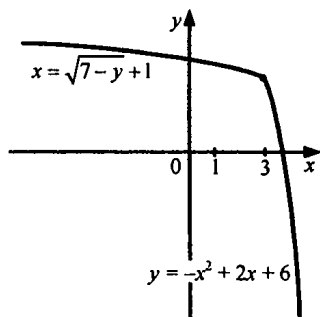

г) $y = -x^2 + 2x + 6, x \in (3; +\infty)$

$$\Rightarrow x = \sqrt{7-y} + 1$$

Глава 2. Тригонометрические функции

§ 4. Числовая окружность

В задачах 4.1–4.4 требуется найти длину дуги. Она находится по формуле: $\ell = \alpha \cdot r$, где α – радианная мера дуги, r – радиус окружности. Так как рассматривается единичная окружность, то $r=1$, т.е. $\ell = \alpha$. Переход от градусной к радианной мере:

$$\alpha = \frac{\beta}{180} \cdot \pi, \text{ где } \beta \text{ – мера угла в градусах.}$$

$$4.1. \overset{U}{AM} = 90^\circ + 45^\circ = 135^\circ, l_{AM} = \frac{3}{4}\pi;$$

$$\overset{U}{BK} = 90^\circ + 30^\circ = 120^\circ, l_{BK} = \frac{2}{3}\pi;$$

$$\overset{U}{MP} = 45^\circ + 60^\circ = 105^\circ, l_{MP} = \frac{7}{12}\pi;$$

$$\overset{U}{DC} = 270^\circ, l_{DC} = \frac{3}{2}\pi;$$

$$\overset{U}{KA} = 150^\circ, l_{KA} = \frac{5}{6}\pi;$$

$$\overset{U}{BP} = 150^\circ, l_{BP} = \frac{5}{6}\pi;$$

$$\overset{U}{CB} = 270^\circ, l_{CB} = \frac{3}{2}\pi; \quad \overset{U}{BC} = 90^\circ, l_{BC} = \frac{1}{2}\pi.$$

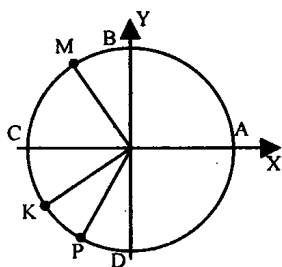

$$4.2. \overset{U}{AM} = 45^\circ, l_{AM} = \frac{\pi}{4};$$

$$\overset{U}{BD} = 180^\circ, l_{BD} = \pi;$$

$$\overset{U}{CK} = 120^\circ, l_{CK} = \frac{2}{3}\pi;$$

$$\overset{U}{MP} = 285^\circ, l_{MP} = \frac{19}{12}\pi;$$

$$\overset{U}{DM} = 135^\circ, l_{DM} = \frac{3}{4}\pi;$$

$$\overset{U}{MK} = 360^\circ - 105^\circ = 255^\circ, l_{MK} = \frac{17}{12}\pi;$$

$$\overset{U}{CP} = 150^\circ, l_{CP} = \frac{5}{6}\pi; \quad \overset{U}{PC} = 210^\circ, l_{PC} = \frac{7}{6}\pi.$$

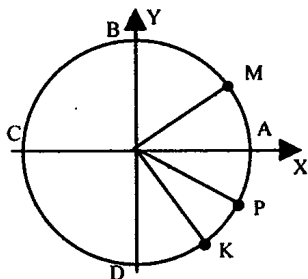

$$4.3. l_{AM} = \frac{\pi}{2} \cdot \frac{2}{2+3} = \frac{\pi}{5};$$

$$l_{MB} = \frac{\pi}{2} - \frac{\pi}{5} = \frac{3}{10}\pi; \quad l_{DM} = \frac{\pi}{2} + \frac{\pi}{5} = \frac{7}{10}\pi;$$

$$l_{MC} = \frac{3}{10}\pi + \frac{\pi}{2} = \frac{4}{5}\pi.$$

$$4.4. l_{EP} = \frac{\pi}{2} \cdot \frac{1}{1+5} = \frac{\pi}{12};$$

$$l_{PD} = \frac{\pi}{2} \cdot \frac{5}{1+5} = \frac{5\pi}{12}$$

$$l_{AP} = l_{AC} + l_{CP} = \frac{13}{12}\pi.$$

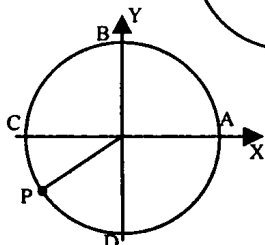
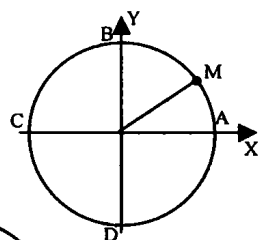

$$4.5. \text{a) } \frac{\pi}{2}; (0; 1). \quad \text{б) } \pi; (-1; 0).$$

$$\text{в) } \frac{3\pi}{2}; (0; -1). \quad \text{г) } 2\pi; (1; 0).$$

$$4.6. \text{a) } 7\pi; (-1; 0). \quad \text{б) } 4\pi; (1; 0). \quad \text{в) } 10\pi; (1; 0). \quad \text{г) } 3\pi; (-1; 0).$$

$$4.7. \text{a) } \frac{\pi}{3}; \left(\frac{1}{2}; \frac{\sqrt{3}}{2}\right). \quad \text{б) } \frac{\pi}{4}; \left(\frac{\sqrt{2}}{2}; \frac{\sqrt{2}}{2}\right). \quad \text{в) } \frac{\pi}{6}; \left(\frac{\sqrt{3}}{2}; \frac{1}{2}\right).$$

$$\text{г) } \frac{\pi}{8}; \cos^2 \frac{\pi}{8} = \frac{1 + \cos \frac{\pi}{4}}{2}; \cos \frac{\pi}{8} = \sqrt{\frac{1 + \frac{\sqrt{2}}{2}}{2}} = \frac{\sqrt{2 + \sqrt{2}}}{2}; \sin^2 \frac{\pi}{8} = \frac{1 - \cos \frac{\pi}{4}}{2};$$

$$\sin \frac{\pi}{8} = \frac{\sqrt{2 - \sqrt{2}}}{2}; \left(\frac{\sqrt{2 + \sqrt{2}}}{2}; \frac{\sqrt{2 - \sqrt{2}}}{2}\right).$$

$$4.8. \text{a) } \frac{2\pi}{3}; \left(-\frac{1}{2}; \frac{\sqrt{3}}{2}\right);$$

$$\text{б) } \frac{3\pi}{4}; \left(-\frac{\sqrt{2}}{2}; \frac{\sqrt{2}}{2}\right);$$

$$\text{в) } \frac{5\pi}{6}; \left(-\frac{\sqrt{3}}{2}; \frac{1}{2}\right);$$

$$\text{г) } \frac{5\pi}{4}; \left(-\frac{\sqrt{2}}{2}; -\frac{\sqrt{2}}{2}\right).$$

$$4.9. \text{a) } \frac{4\pi}{3}; \left(-\frac{1}{2}; -\frac{\sqrt{3}}{2}\right);$$

$$\text{б) } \frac{5\pi}{3}; \left(\frac{1}{2}; -\frac{\sqrt{3}}{2}\right);$$

$$\text{в) } \frac{7\pi}{6}; \left(-\frac{\sqrt{3}}{2}; -\frac{1}{2}\right);$$

$$\text{г) } \frac{11\pi}{6}; \left(\frac{\sqrt{3}}{2}; -\frac{1}{2}\right).$$

$$4.10. \text{a) } -\frac{\pi}{2}; (0; -1);$$

$$\text{б) } -\frac{2\pi}{3}; \left(-\frac{1}{2}; -\frac{\sqrt{3}}{2}\right);$$

$$\text{в) } -2\pi; (1; 0);$$

$$\text{г) } -\frac{3\pi}{4}; \left(-\frac{\sqrt{2}}{2}; -\frac{\sqrt{2}}{2}\right).$$

4.11. а) $\frac{25\pi}{4}, (\frac{\sqrt{2}}{2}; \frac{\sqrt{2}}{2})$; б) $-\frac{26\pi}{3}, (-\frac{1}{2}; -\frac{\sqrt{3}}{2})$;
 в) $-\frac{25\pi}{6}, (\frac{\sqrt{3}}{2}; -\frac{1}{2})$; г) $\frac{16\pi}{3}, (-\frac{1}{2}; -\frac{\sqrt{3}}{2})$.

4.12.

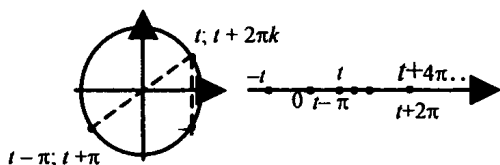

- а) $t; -t$. на прямой: симметрично относительно нуля; на окружности: симметрично относительно оси x .
 б) $t; t + 2\pi k$. на прямой: стоят с периодом $2\pi k$; на окружности: совпадают.
 в) $t; t + \pi$. на прямой: стоят на расстоянии в π ; на окружности: диаметрально противоположны.
 г) $t + \pi, t - \pi$. на прямой: стоят на расстоянии в 2π ; на окружности: совпадают

4.13. а) $M_1 \left(\frac{\pi}{4} \right): \frac{\pi}{4} + 2\pi k, k \in \mathbb{Z}$;

б) $M_2(5): 5 + 2\pi k, k \in \mathbb{Z}$;

в) $M_3 \left(\frac{3\pi}{4} \right): \frac{3\pi}{4} + 2\pi k, k \in \mathbb{Z}$

г) $M_4(-3): -3 + \pi k, k \in \mathbb{Z}$.

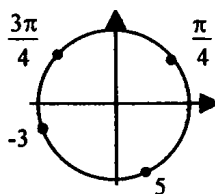

4.14. а) $A: 2\pi k$;

б) $C: \pi + 2\pi k$;

в) A и $C: \pi n$

4.16. а) 1: $(0, 540; 0, 841)$;

б) - 5: $(0, 284; 0, 950)$;

в) 4,5: $(-0, 211; -0, 978)$;

г) (-3): $(-0, 990; -0, 141)$.

4.17. а) 6: IV; б) 2: II; в) 3: II; г) 4: III.

4.18. а) 5: IV; б) - 5: I; в) 8: II; г) - 8: III.

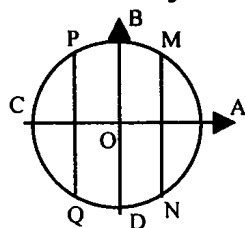

4.19. а) $AM: t \in (2\pi k; \frac{\pi}{4} + 2\pi k)$; б) $CM: t \in (-\pi + 2\pi k; \frac{\pi}{4} + 2\pi k)$

в) $MA: t \in (\frac{\pi}{4} + 2\pi k; 2\pi + 2\pi k)$ г) $MC: t \in (\frac{\pi}{4} + 2\pi k; \pi + 2\pi k)$

4.20. а) $DM: t \in (-\frac{\pi}{2} + 2\pi k; \frac{3\pi}{4} + 2\pi k)$

$$5.5. \text{ а) } M\left(\frac{1}{2}; \frac{\sqrt{3}}{2}\right): \min \text{ положит.} = \frac{\pi}{3}, \text{ max отрицат.} = \frac{5\pi}{3}$$

$$\text{б) } M\left(-\frac{1}{2}; \frac{\sqrt{3}}{2}\right): \min \text{ положит.} = \frac{2\pi}{3}, \text{ max отрицат.} = \frac{4\pi}{3}$$

$$\text{в) } M\left(-\frac{1}{2}; -\frac{\sqrt{3}}{2}\right): \min \text{ положит.} = \frac{4\pi}{3}, \text{ max отрицат.} = \frac{2\pi}{3}$$

$$\text{г) } M\left(\frac{1}{2}; -\frac{\sqrt{3}}{2}\right): \min \text{ положит.} = \frac{5\pi}{3}, \text{ max отрицат.} = \frac{\pi}{3}$$

$$5.6. \text{ а) } y = \frac{\sqrt{2}}{2}; \left(\frac{\sqrt{2}}{2}; \frac{\sqrt{2}}{2}\right) \text{ и } \left(-\frac{\sqrt{2}}{2}; \frac{\sqrt{2}}{2}\right); t = \frac{\pi}{4} + 2\pi n; \frac{3\pi}{4} + 2\pi n;$$

$$\text{б) } y = \frac{1}{2}; \frac{1}{2} \text{ и } \left(-\frac{\sqrt{3}}{2}; \frac{1}{2}\right); t = \frac{\pi}{6} + 2\pi n; \frac{5\pi}{6} + 2\pi n;$$

$$\text{в) } y = 0; (1; 0) \text{ и } (-1; 0) \quad t = \pi n;$$

$$\text{г) } y = \frac{\sqrt{3}}{2}; \left(\frac{1}{2}; \frac{\sqrt{3}}{2}\right) \text{ и } \left(-\frac{1}{2}; \frac{\sqrt{3}}{2}\right) \quad t = \frac{\pi}{3} + 2\pi n, \frac{2\pi}{3} + 2\pi n.$$

$$5.7. \text{ а) } y = -\frac{\sqrt{3}}{2}, \left(\frac{1}{2}; -\frac{\sqrt{3}}{2}\right) \text{ и } \left(-\frac{1}{2}; -\frac{\sqrt{3}}{2}\right) \quad x = (-1)^{k+1} \frac{\pi}{3} + \pi k;$$

$$\text{б) } y = 1, (0; 1), x = \frac{\pi}{2} + 2\pi k;$$

$$\text{в) } y = -\frac{\sqrt{2}}{2}, \left(\frac{\sqrt{2}}{2}; -\frac{\sqrt{2}}{2}\right) \text{ и } \left(-\frac{\sqrt{2}}{2}; -\frac{\sqrt{2}}{2}\right) \quad x = (-1)^{k+1} \frac{\pi}{4} + \pi k;$$

$$\text{г) } y = -1, (0; -1) \quad x = -\frac{\pi}{2} + 2\pi k.$$

$$5.8. \text{ а) } x = \frac{\sqrt{3}}{2}, \left(\frac{\sqrt{3}}{2}; \frac{1}{2}\right) \text{ и } \left(\frac{\sqrt{3}}{2}; -\frac{1}{2}\right) \quad x = \pm \frac{\pi}{6} + 2\pi k;$$

$$\text{б) } x = \frac{1}{2}, \left(\frac{1}{2}; \frac{\sqrt{3}}{2}\right) \text{ и } \left(\frac{1}{2}; -\frac{\sqrt{3}}{2}\right) \quad y = \pm \frac{\pi}{3} + 2\pi k;$$

$$\text{в) } x = 1, (1; 0) \quad y = 2\pi n;$$

$$\text{г) } x = \frac{\sqrt{2}}{2}, \left(\frac{\sqrt{2}}{2}; \frac{\sqrt{2}}{2}\right) \text{ и } \left(\frac{\sqrt{2}}{2}; -\frac{\sqrt{2}}{2}\right) \quad y = \pm \frac{\pi}{4} + 2\pi k.$$

$$5.9. \text{ а) } x = 0, (0; 1) \text{ и } (0; -1) \quad y = \pi/2 + \pi n;$$

$$\text{б) } x = -\frac{1}{2}, \left(-\frac{1}{2}; \frac{\sqrt{3}}{2}\right) \text{ и } \left(-\frac{1}{2}; -\frac{\sqrt{3}}{2}\right) \quad y = \pm \frac{2\pi}{3} + 2\pi k;$$

$$в) x = -\frac{\sqrt{3}}{2}, \left(-\frac{\sqrt{3}}{2}; \frac{1}{2}\right) \text{ и } \left(-\frac{\sqrt{3}}{2}; -\frac{1}{2}\right) y = \pm \frac{5\pi}{6} + 2\pi k;$$

$$г) x = -1, (-1; 0). y = \pi + 2\pi n.$$

5.10. см. ответ

$$5.11. а) x > 0, t \in \left(-\frac{\pi}{2} + 2\pi n; \frac{\pi}{2} + 2\pi n\right);$$

$$б) x < \frac{1}{2}, t \in \left(\frac{\pi}{3} + 2\pi n; \frac{5\pi}{3} + 2\pi n\right);$$

$$в) x > \frac{1}{2}, t \in \left(-\frac{\pi}{3} + 2\pi n; \frac{\pi}{3} + 2\pi n\right);$$

$$г) x < 0, t \in \left(\frac{\pi}{2} + 2\pi n; \frac{3}{2}\pi + 2\pi n\right).$$

$$5.12. а) x < \frac{\sqrt{2}}{2}, t \in \left(\frac{\pi}{4} + 2\pi k; \frac{7\pi}{4} + 2\pi k\right);$$

$$б) x > -\frac{\sqrt{2}}{2}, t \in \left(-\frac{3\pi}{4} + 2\pi k; \frac{3\pi}{4} + 2\pi k\right);$$

$$в) x \leq -\frac{\sqrt{3}}{2}, t \in \left(\frac{5\pi}{6} + 2\pi k; \frac{7\pi}{6} + 2\pi k\right); \quad г) x \geq \frac{\sqrt{3}}{2}, t \in \left(-\frac{\pi}{6} + 2\pi k; \frac{\pi}{6} + 2\pi k\right);$$

$$5.13. а) y > 0, t \in (2\pi k; \pi + 2\pi k); \quad б) y < \frac{1}{2}, t \in \left(\frac{5\pi}{6} + 2\pi k; \frac{\pi}{6} + 2\pi k\right);$$

$$в) y > \frac{1}{2}, t \in \left(\frac{\pi}{6} + 2\pi k; \frac{5\pi}{6} + 2\pi k\right); \quad г) y < 0, t \in (-\pi + 2\pi k; 2\pi k).$$

$$5.14. а) y < \frac{\sqrt{2}}{2}, -\frac{5\pi}{4} + 2\pi k < t < \frac{\pi}{4} + 2\pi k; \quad б) y > -\frac{\sqrt{2}}{2}, -\frac{\pi}{4} + 2\pi k < t < \frac{5\pi}{4} + 2\pi k;$$

$$в) y \leq -\frac{\sqrt{3}}{2}, \frac{4\pi}{3} + 2\pi k < t < \frac{5\pi}{3} + 2\pi k; \quad г) y \geq \frac{\sqrt{3}}{2}, \frac{\pi}{3} + 2\pi k < t < \frac{2\pi}{3} + 2\pi k;$$

§ 6. Синус и косинус. Тангенс и котангенс.

$$6.1. а) \sin 0 = 0, \cos 0 = 1, \operatorname{tg} 0 = 0,$$

$$б) \sin \frac{\pi}{2} = 1, \cos \frac{\pi}{2} = 0, \operatorname{tg} \frac{\pi}{2} = +\infty;$$

$$в) \sin \frac{3\pi}{2} = -1, \cos \frac{3\pi}{2} = 0, \operatorname{tg} \frac{3\pi}{2} = -\infty;$$

$$г) \sin \pi = 0, \cos \pi = -1, \operatorname{tg} \pi = 0.$$

$$6.2. а) \sin(-2\pi) = 0, \cos(-2\pi) = 1, \operatorname{tg}(-2\pi) = 0;$$

$$\text{б) } \sin\left(-\frac{\pi}{2}\right) = -1, \quad \cos\left(-\frac{\pi}{2}\right) = 0, \quad \operatorname{tg}\left(-\frac{\pi}{2}\right) = -\infty;$$

$$\text{в) } \sin\left(-\frac{3\pi}{2}\right) = 1, \quad \operatorname{tg}\left(-\frac{3\pi}{2}\right) = +\infty, \quad \cos\left(-\frac{3\pi}{2}\right) = 0;$$

$$\text{г) } \sin(-\pi) = 0, \quad \cos(-\pi) = -1, \quad \operatorname{tg}(-\pi) = 0.$$

$$6.3. \text{ а) } \sin\frac{5\pi}{6} = \frac{1}{2}, \quad \cos\frac{5\pi}{6} = -\frac{\sqrt{3}}{2}, \quad \operatorname{tg}\left(\frac{5\pi}{6}\right) = -\frac{1}{\sqrt{3}};$$

$$\text{б) } \sin\frac{5\pi}{4} = -\frac{\sqrt{2}}{2}, \quad \cos\frac{5\pi}{4} = -\frac{\sqrt{2}}{2}, \quad \operatorname{tg}\left(\frac{5\pi}{4}\right) = 1;$$

$$\text{в) } \sin\frac{7\pi}{6} = -\frac{1}{2}, \quad \cos\frac{7\pi}{6} = -\frac{\sqrt{3}}{2}, \quad \operatorname{tg}\left(\frac{7\pi}{6}\right) = \frac{1}{\sqrt{3}};$$

$$\text{г) } \sin\frac{7\pi}{4} = -\frac{\sqrt{2}}{2}, \quad \cos\frac{7\pi}{4} = \frac{\sqrt{2}}{2}, \quad \operatorname{tg}\left(\frac{7\pi}{4}\right) = -1.$$

$$6.4. \text{ а) } \sin\left(-\frac{7\pi}{4}\right) = \frac{\sqrt{2}}{2}, \quad \cos\left(-\frac{7\pi}{4}\right) = \frac{\sqrt{2}}{2}, \quad \operatorname{tg}\left(-\frac{7\pi}{4}\right) = 1;$$

$$\text{б) } \sin\left(-\frac{4\pi}{3}\right) = \frac{\sqrt{3}}{2}, \quad \cos\left(-\frac{4\pi}{3}\right) = -\frac{1}{2}, \quad \operatorname{tg}\left(-\frac{4\pi}{3}\right) = -\sqrt{3};$$

$$\text{в) } \sin\left(-\frac{5\pi}{6}\right) = -\frac{1}{2}, \quad \cos\left(-\frac{5\pi}{6}\right) = -\frac{\sqrt{3}}{2}, \quad \operatorname{tg}\left(-\frac{5\pi}{6}\right) = \frac{1}{\sqrt{3}};$$

$$\text{г) } \sin\left(-\frac{5\pi}{3}\right) = \frac{\sqrt{3}}{2}, \quad \cos\left(-\frac{5\pi}{3}\right) = \frac{1}{2}, \quad \operatorname{tg}\left(-\frac{5\pi}{3}\right) = \sqrt{3}.$$

$$6.5. \text{ а) } \sin\frac{13\pi}{6} = \frac{1}{2}, \quad \cos\frac{13\pi}{6} = \frac{\sqrt{3}}{2}, \quad \operatorname{tg}\left(\frac{13\pi}{6}\right) = \frac{1}{\sqrt{3}};$$

$$\text{б) } \sin\left(-\frac{8\pi}{3}\right) = -\frac{\sqrt{3}}{2}, \quad \cos\left(-\frac{8\pi}{3}\right) = -\frac{1}{2}, \quad \operatorname{tg}\left(-\frac{8\pi}{3}\right) = \sqrt{3};$$

$$\text{в) } \sin\frac{23\pi}{6} = -\frac{1}{2}, \quad \cos\frac{23\pi}{6} = \frac{\sqrt{3}}{2}, \quad \operatorname{tg}\left(\frac{23\pi}{6}\right) = -\frac{1}{\sqrt{3}};$$

$$\text{г) } \sin\left(-\frac{11\pi}{4}\right) = \frac{\sqrt{2}}{2}, \quad \cos\left(-\frac{11\pi}{4}\right) = \frac{\sqrt{2}}{2}, \quad \operatorname{tg}\left(-\frac{11\pi}{4}\right) = 1.$$

$$6.6. \text{ а) } \sin\left(-\frac{\pi}{4}\right) + \cos\frac{\pi}{3} + \cos\left(-\frac{\pi}{6}\right) = -\frac{\sqrt{2}}{2} + \frac{1}{2} + \frac{\sqrt{3}}{2} = \frac{\sqrt{3} + 1 - \sqrt{2}}{2};$$

$$\text{б) } \cos\frac{\pi}{6} \cos\frac{\pi}{4} \cos\frac{\pi}{3} \cos\frac{\pi}{2} = 0, \quad \text{т.к. } \cos\frac{\pi}{2} = 0;$$

$$\text{в) } \sin\left(-\frac{\pi}{2}\right) - \cos(-\pi) + \sin\left(-\frac{3\pi}{2}\right) = -1 + 1 + 1 = 1;$$

$$r) \sin \frac{\pi}{6} \sin \frac{\pi}{4} \sin \frac{\pi}{3} \sin \frac{\pi}{2} = \frac{1}{2} \cdot \frac{\sqrt{2}}{2} \cdot \frac{\sqrt{3}}{2} \cdot 1 = \frac{\sqrt{6}}{8}.$$

$$6.7. a) \sin\left(-\frac{3\pi}{4}\right) + \cos\left(-\frac{\pi}{4}\right) + \sin \frac{\pi}{4} \cos \frac{\pi}{2} + \cos 0 \sin \frac{\pi}{2} = \\ = \frac{\sqrt{2}}{2} + \frac{\sqrt{2}}{2} + 1 = 1;$$

$$b) \cos \frac{5\pi}{3} + \cos \frac{4\pi}{3} + \sin \frac{3\pi}{2} \sin \frac{5\pi}{8} \cos \frac{3\pi}{2} = \frac{1}{2} - \frac{1}{2} = 0.$$

$$6.8. a) \operatorname{tg} \frac{\pi}{4} + \operatorname{ctg} \frac{5\pi}{4} = 1 + 1 = 2; \quad b) \operatorname{ctg} \frac{\pi}{3} \cdot \operatorname{tg} \frac{\pi}{6} = \frac{\sqrt{3}}{3} \cdot \frac{\sqrt{3}}{3} = \frac{1}{3};$$

$$b) \operatorname{tg} \frac{\pi}{6} - \operatorname{ctg} \frac{\pi}{6} = \frac{\sqrt{3}}{3} - \sqrt{3} = \frac{-2\sqrt{3}}{3}; \quad r) \operatorname{tg} \frac{9\pi}{4} + \operatorname{ctg} \frac{\pi}{4} = 1 + 1 = 2.$$

$$6.9. a) \operatorname{tg} \frac{\pi}{4} \cdot \sin \frac{\pi}{3} \cdot \operatorname{ctg} \frac{\pi}{6} = 1 \cdot \frac{\sqrt{3}}{2} \cdot \sqrt{3} = \frac{3}{2};$$

$$b) 2 \sin \pi + 3 \cos \pi + \operatorname{ctg} \frac{\pi}{2} = 0 - 3 + 0 = -3;$$

$$b) \sin \frac{\pi}{3} = \cos \frac{\pi}{6} = \frac{\sqrt{3}}{2}, \operatorname{tg} \frac{\pi}{3} = \sqrt{3} \Rightarrow 0$$

$$r) \operatorname{tg} 0 = 0, \cos \frac{3\pi}{2} = 0, \sin \frac{\pi}{3} = \frac{\sqrt{3}}{2} \Rightarrow -4,5$$

$$6.10. a) \operatorname{tg} \frac{\pi}{5} \cdot \operatorname{ctg} \frac{\pi}{5} = 1; \quad b) 3 \operatorname{tg} 2,3 \cdot \operatorname{ctg} 2,3 = 3;$$

$$b) \operatorname{tg} \frac{\pi}{7} \cdot \operatorname{ctg} \frac{\pi}{7} = 1; \quad r) 7 \operatorname{ctg} \frac{\pi}{12} \cdot \operatorname{ctg} \frac{\pi}{12} = 7.$$

$$6.11. a) \sin t \cdot \operatorname{ctg} t = \cos t, \sin t \cdot \frac{\cos t}{\sin t} = \cos t;$$

$$b) \frac{\sin t}{\operatorname{tg} t} = \cos t, \sin t \cdot \frac{\cos t}{\sin t} = \cos t;$$

$$b) \cos t \cdot \operatorname{tg} t = \sin t, \cos t \cdot \frac{\sin t}{\cos t} = \sin t;$$

$$r) \frac{\cos t}{\operatorname{ctg} t} = \sin t, \cos t \cdot \frac{\sin t}{\cos t} = \sin t.$$

$$6.12. a) \sin t \cdot \cos t \cdot \operatorname{tg} t = \sin t \cdot \cos t \cdot \frac{\sin t}{\cos t} = \sin^2 t;$$

$$b) \sin t \cdot \cos t \cdot \operatorname{ctg} t - 1 = \sin t \cdot \cos t \cdot \frac{\cos t}{\sin t} - 1 = \cos^2 t - 1 = -\sin^2 t;$$

$$в) \sin^2 t - \operatorname{tg} t \cdot \operatorname{ctg} t = \sin^2 t - 1 = -\cos^2 t;$$

$$г) \frac{1 - \cos^2 t}{1 - \sin^2 t} = \frac{\sin^2 t}{\cos^2 t} = \operatorname{tg}^2 t.$$

$$6.13. а) \cos 2t, t = \frac{\pi}{2}, \cos \pi = -1; \quad б) \sin \frac{t}{2}, t = -\frac{\pi}{3}, \sin\left(-\frac{\pi}{6}\right) = -\frac{1}{2};$$

$$в) \sin 2t, t = -\frac{\pi}{6}, \sin\left(-\frac{\pi}{3}\right) = -\frac{\sqrt{3}}{2}; \quad г) \cos \frac{1}{2}, t = -\frac{\pi}{3}, \cos\left(-\frac{\pi}{6}\right) = \frac{\sqrt{3}}{2}.$$

$$6.14. а) \sin^2 t - \cos^2 t, t = \frac{\pi}{3}, \sin^2 \frac{\pi}{3} - \cos^2 \frac{\pi}{3} = \frac{3}{4} - \frac{1}{4} = \frac{1}{2};$$

$$б) \sin^2 t + \cos^2 t, \forall t, \text{ в том числе для } t = \frac{\pi}{4};$$

$$в) \sin^2 t - \cos^2 t, t = \frac{\pi}{4}, \sin^2 \frac{\pi}{4} - \cos^2 \frac{\pi}{4} = 0;$$

$$г) \sin^2 t + \cos^2 t, \text{ см. п. б).}$$

$$6.15. а) f(t) = 2 \sin t; f_{\max} = 2, f_{\min} = -2.$$

$$б) f(t) = 3 + 4 \cos t; f_{\max} = 7, f_{\min} = -1.$$

$$в) f(t) = -3 \cos t; f_{\max} = 3, f_{\min} = -3.$$

$$г) f(t) = 3 - 5 \sin t; f_{\max} = 8, f_{\min} = -2.$$

$$6.16. а) \cos t = \frac{\sqrt{2}}{2}, t = \pm \frac{\pi}{4} + 2\pi n; \quad б) \sin t = -\frac{1}{2}, t = (-1)^{n+1} \frac{\pi}{6} + \pi n;$$

$$в) \cos t = -\frac{1}{2}, t = \pm \frac{2\pi}{3} + 2\pi n; \quad г) \sin t = \frac{\sqrt{2}}{2}, t = (-1)^n \frac{\pi}{4} + \pi n.$$

$$6.17. а) \sin t = -\frac{\sqrt{3}}{2}, t = (-1)^{k+1} \frac{\pi}{3} + \pi k;$$

$$б) \operatorname{cost} = \sqrt{3} \text{ решений нет } |\operatorname{cost}| \leq 1;$$

$$в) \cos t = \frac{\sqrt{3}}{2}, t = \pm \frac{5\pi}{6} + 2\pi n;$$

$$г) \cos t = -\frac{\pi}{3} \text{ решений нет, т.к. } |\cos t| \leq 1.$$

$$6.18. а) \sin t + 1 = 0, \sin t = -1, t = -\frac{\pi}{2} + 2\pi n;$$

$$б) \cos t - 1 = 0, \cos t = 1, t = 2\pi n;$$

$$в) 1 - 2 \sin t = 0, \sin t = \frac{1}{2}, t = (-1)^n \frac{\pi}{6} + \pi n;$$

$$г) 2 \cos t + 1 = 0, \cos t = -\frac{1}{2}, t = \pm \frac{2\pi}{3} + 2\pi n.$$

$$6.19. а) \frac{\sin t - 1}{\operatorname{cost}}, \cos t \neq 0, t \neq \frac{\pi}{2} + \pi n;$$

$$\text{б) } 2 \sin t = \sqrt{3} \Rightarrow \sin t = \frac{\sqrt{3}}{2} \Rightarrow t = (-1)^n \frac{\pi}{3} + \pi n, n \in \mathbb{Z}$$

$$\text{в) } \sin t = 1 \Rightarrow t = \frac{\pi}{2} + 2\pi n, n \in \mathbb{Z}$$

$$\text{г) } \cos t = \frac{1}{2} \Rightarrow t = \pm \frac{\pi}{4} + 2\pi n, n \in \mathbb{Z}$$

$$\text{6.20. а) } \sin \frac{4\pi}{7} > 0;$$

$$\text{б) } \cos \left(-\frac{5\pi}{7}\right) < 0;$$

$$\text{в) } \sin \frac{9\pi}{8} < 0;$$

$$\text{г) } \sin \left(-\frac{3\pi}{8}\right) < 0.$$

6.21. см. ответ

$$\text{6.22. а) } \sin(-2) < 0; \quad \text{б) } \cos 3 < 0; \quad \text{в) } \sin 5 < 0; \quad \text{г) } \cos(-6) > 0.$$

$$\text{6.23. а) } \sin 10 < 0; \quad \text{б) } \cos(-12) > 0; \quad \text{в) } \sin(-15) < 0; \quad \text{г) } \cos 8 < 0.$$

$$\text{6.24. а) } \sin 1 \cos 2 < 0;$$

$$\text{б) } \sin \frac{\pi}{7} \cos \left(-\frac{7\pi}{5}\right) < 0;$$

$$\text{в) } \cos 2 \sin(-3) > 0;$$

$$\text{г) } \cos \left(-\frac{14\pi}{9}\right) \sin \left(-\frac{4\pi}{9}\right) < 0.$$

$$\text{6.25. а) } \cos \frac{5\pi}{9} - \operatorname{tg} \frac{25\pi}{18} < 0; \quad \text{б) } \operatorname{tg} 1 - \cos 2 > 0;$$

$$\text{в) } \sin \frac{7\pi}{10} - \operatorname{ctg} \frac{3\pi}{5} > 0; \quad \text{г) } \sin 2 - \operatorname{ctg} 5,5 > 0.$$

$$\text{6.26. а) } \sin 1 \cdot \cos 2 \cdot \operatorname{tg} 3 \cdot \operatorname{ctg} 4 > 0;$$

$$\text{б) } \sin(-5) \cos(-6) \operatorname{tg}(-7) \operatorname{ctg}(-8) < 0.$$

$$\text{6.27. а) } \cos 1 + \cos(1 + \pi) + \sin\left(-\frac{\pi}{3}\right) + \cos\left(-\frac{\pi}{6}\right) =$$

$$= \cos 1 - \cos 1 - \frac{\sqrt{3}}{2} + \frac{\sqrt{3}}{2} = 0$$

$$\text{б) } \sin 2 + \sin(2 + \pi) + \cos^2\left(-\frac{\pi}{12}\right) + \sin^2 \frac{\pi}{12} = \sin 2 - \sin 2 + 1 = 1.$$

$$\text{6.28. а) } \sin^2(1,5 + 2\pi k) + \cos^2 1,5 + \cos\left(-\frac{\pi}{4}\right) + \sin\left(-\frac{\pi}{6}\right) =$$

$$= 1 + \frac{\sqrt{2}}{2} - \frac{1}{2} = \frac{\sqrt{2} + 1}{2};$$

$$\text{б) } \cos^2\left(\frac{\pi}{8} + 4\pi\right) + \sin^2\left(\frac{\pi}{8} - 44\pi\right) = \cos^2 \frac{\pi}{8} + \sin^2 \frac{\pi}{8} = 1.$$

$$\text{6.29. а) } \operatorname{tg} 2,5 \cdot \operatorname{ctg} 2,5 + \cos^2 \pi - \sin^2 \frac{\pi}{8} - \cos^2 \frac{\pi}{8} = 1 + 1 - 1 = 1.$$

$$\text{б) } \sin^2 \frac{3\pi}{7} - 2 \operatorname{tg} 1 \cdot \operatorname{ctg} 1 + \cos^2\left(-\frac{3\pi}{7}\right) + \sin^2 \frac{5\pi}{2} = 1 - 2 + 1 = 0.$$

$$6.30. \text{ a) } 10 \sin t = \sqrt{75}, \sin t = \frac{5\sqrt{3}}{10} = \frac{\sqrt{3}}{2}, t = (-1)^n \frac{\pi}{3} + \pi n;$$

$$\text{б) } \sqrt{8} \sin t + 2 = 0, \sin t = -\frac{\sqrt{2}}{2}, t = (-1)^{k+1} \frac{\pi}{4} + \pi k$$

$$\text{в) } 8 \cos t - \sqrt{32} = 0, \cos t = \frac{\sqrt{2}}{2}, t = \pm \frac{\pi}{4} + 2\pi k;$$

$$\text{г) } 8 \cos t = -\sqrt{48}, \cos t = -\frac{\sqrt{3}}{2}, t = \pm \frac{5\pi}{6} + 2\pi k$$

$$6.31. \text{ a) } \sin^2 \frac{\pi}{8} + \cos^2 \frac{\pi}{8} - \sin \sqrt{2} = 0, \sin t = \frac{\sqrt{2}}{2}, t = (-1)^k \frac{\pi}{4} + \pi k$$

$$\text{б) } \sqrt{\frac{4}{3}} \cos t = \cos^2 t + \sin^2 t, \cos t = \frac{\sqrt{3}}{2}, t = \pm \frac{\pi}{6} + 2\pi n.$$

$$6.32. \text{ a) } |\sin t| = 1, \sin t = \pm 1, \quad t = \frac{\pi}{2} + \pi n$$

$$\text{б) } \sqrt{1 - \sin^2 t} = \frac{1}{2}, |\cos t| = \frac{1}{2}, \cos t = \pm \frac{1}{2}, \quad t = \pm \frac{\pi}{3} + \pi k$$

$$\text{в) } |\cos t| = 1, \cos t = \pm 1, \quad t = \pi n$$

$$\text{г) } \sqrt{1 - \cos^2 t} = \frac{\sqrt{2}}{2}, |\sin t| = \frac{\sqrt{2}}{2}, \sin t = \pm \frac{\sqrt{2}}{2}, \quad t = \frac{\pi}{4} + \frac{\pi n}{2}.$$

$$6.33. \text{ a) } \sqrt{\sin 10}, 2\pi - \text{Да};$$

$$\text{б) } \sqrt{\cos 1, 3\pi} - \text{Нет};$$

$$\text{в) } \sqrt{\sin(-3, 4)\pi} - \text{Да};$$

$$\text{г) } \sqrt{\cos(-6, 9\pi)} - \text{Нет}.$$

$$6.34. \text{ a) } \frac{\pi}{2} < \frac{7\pi}{10} < \frac{5\pi}{6} < \pi \Rightarrow a > b$$

$$\text{б) } a = \sin 2 > b = \cos 2;$$

$$\text{в) } 0 < \frac{\pi}{8} < \frac{\pi}{3} < \frac{\pi}{2} \Rightarrow a > b;$$

$$\text{г) } a = \sin 1 > b = \cos 1;$$

$$6.35. \text{ a) } \frac{10\pi}{9} = \pi + \frac{\pi}{9} \Rightarrow \sin \frac{2\pi}{9} - \sin \frac{10\pi}{9} = \sin \frac{2\pi}{9} + \sin \frac{\pi}{9} > 0$$

$$\text{б) } \sin 1 - \sin 1, 1 < 0, \text{ т.к. } 0 < 1 < 1, 1 < \frac{\pi}{2}$$

$$\text{в) } \frac{15\pi}{8} = 2\pi - \frac{\pi}{8} \Rightarrow \sin \frac{15\pi}{8} - \cos \frac{\pi}{4} = -\sin \frac{\pi}{8} - \cos \frac{\pi}{4} < 0$$

$$\text{г) } \cos 1 - \cos 0, 9 < 0, \text{ т.к. } 0 < 0, 9 < 1 < \frac{\pi}{2}$$

$$6.36. \text{ a) } \sin \frac{4\pi}{3}, \sin \frac{7\pi}{6}, \sin \frac{\pi}{7}, \sin \frac{\pi}{5}, \sin \frac{2\pi}{3};$$

$$\text{б) } \cos \frac{5\pi}{6}, \cos \frac{5\pi}{4}, \cos \frac{\pi}{3}, \cos \frac{7\pi}{4}, \cos \frac{\pi}{8}.$$

- 6.37. а) $\cos 4, \sin 3, \cos 5, \sin 2$; б) $\cos 3, \cos 4, \cos 7, \cos 6$;
 в) $\sin 4, \sin 6, \sin 3, \sin 7$; г) $\cos 3, \sin 5, \sin 4, \cos 2$.
 6.38. а) $\cos 1, \sin 1, 1, \operatorname{tg} 1$. б) $\operatorname{ctg} 2, \cos 2, \sin 2, 2$.
 6.39. а) $\sin t > 0, t \in (2\pi k; \pi + 2\pi k)$;
 б) $\sin t < \frac{\sqrt{3}}{2}, t \in (-\frac{4\pi}{3} + 2\pi k; \frac{\pi}{3} + 2\pi k)$;
 в) $\sin t < 0, t \in (-\pi + 2\pi k; 2\pi k)$;
 г) $\sin t > \frac{\sqrt{3}}{2}, t \in (\frac{\pi}{3} + 2\pi k; \frac{2\pi}{3} + 2\pi k)$.
 6.40. а) $\cos t > 0, t \in (-\frac{\pi}{2} + 2\pi k; \frac{\pi}{2} + 2\pi k)$;
 б) $\cos t < \frac{\sqrt{2}}{2}, t \in (\frac{\pi}{4} + 2\pi k; \frac{7\pi}{4} + 2\pi k)$;
 в) $\cos t < 0, t \in (\frac{\pi}{2} + 2\pi k; \frac{3\pi}{2} + 2\pi k)$;
 г) $\cos t > \frac{\sqrt{2}}{2}, t \in (-\frac{\pi}{4} + 2\pi k; \frac{\pi}{4} + 2\pi k)$.
 6.41. а) $\sin t > -\frac{\sqrt{2}}{2}, t \in (-\frac{\pi}{4} + 2\pi k; \frac{5\pi}{4} + 2\pi k)$;
 б) $\cos t > -\frac{\sqrt{3}}{2}, t \in (-\frac{5\pi}{6} + 2\pi k; \frac{5\pi}{6} + 2\pi k)$;
 в) $\sin t < -\frac{\sqrt{2}}{2}, t \in (\frac{5\pi}{4} + 2\pi k; \frac{7\pi}{4} + 2\pi k)$;
 г) $\cos t < -\frac{\sqrt{3}}{2}, t \in (\frac{5\pi}{6} + 2\pi k; \frac{7\pi}{6} + 2\pi k)$.

§ 7. Тригонометрические функции числового аргумента

- 7.1. а) $1 - \sin^2 t = \cos^2 t$; б) $\cos^2 t - 1 = -\sin^2 t$;
 в) $1 - \cos^2 t = \sin^2 t$; г) $\sin^2 t - 1 = -\cos^2 t$.
 7.2. а) $(1 - \sin t)(1 + \sin t) = 1 - \sin^2 t = \cos^2 t$;
 б) $\cos^2 t + 1 - \sin^2 t = \cos^2 t + \cos^2 t = 2 \cos^2 t$;
 в) $(1 - \cos t)(1 + \cos t) = 1 - \cos^2 t = \sin^2 t$;
 г) $\sin^2 t + 2 \cos^2 t - 1 = 1 + \cos^2 t - 1 = \cos^2 t$.
 7.3. а) $\frac{1}{\cos^2 t} - 1 = \frac{1 - \cos^2 t}{\cos^2 t} = \operatorname{tg}^2 t$; б) $\frac{1 - \sin^2 t}{\cos^2 t} = 1$;
 в) $1 - \frac{1}{\sin^2 t} = \frac{\sin^2 t - 1}{\sin^2 t} = -\operatorname{ctg}^2 t$; г) $\frac{1 - \cos^2 t}{1 - \sin^2 t} = \frac{\sin^2 t}{\cos^2 t} = \operatorname{tg}^2 t$.

$$7.4. \text{ a) } \frac{(\sin t + \cos t)^2}{1 + 2\sin t \cos t} = \frac{1 + 2\sin t \cos t}{1 + 2\sin t \cos t} = 1;$$

$$\text{б) } \frac{1 - 2\sin t \cos t}{(\cos t - \sin t)^2} = \frac{1 - 2\sin t \cos t}{1 - 2\sin t \cos t} = 1.$$

$$7.5. \text{ a) } \frac{\cos^2 t}{1 - \sin t} - \sin t = 1, \quad \frac{1 - \sin^2 t}{1 - \sin t} - \sin t = \frac{1 - \sin^2 t - \sin t + \sin^2 t}{1 - \sin t} = 1;$$

$$\text{б) } \frac{\sin^2 t}{1 + \cos t} + \cos t = 1, \quad \frac{1 - \cos^2 t}{1 + \cos t} + \cos t = \frac{\sin^2 t + \cos t + \cos^2 t}{1 + \cos t} = 1.$$

$$7.6. \text{ a) } \sin^4 t - \cos^4 t + 2\cos^2 t = 1 - 2\cos^2 t + \cos^4 t - \cos^4 t + 2\cos^2 t = 1;$$

$$\text{б) } \frac{2 - \sin^2 t - \cos^2 t}{3\sin^2 t + 3\cos^2 t} = \frac{2 - 1}{3} = \frac{1}{3};$$

$$\text{в) } \sin^4 t + \cos^4 t + 2\sin^2 t \cos^2 t = (\sin^2 t + \cos^2 t)^2 = 1;$$

$$\text{г) } \frac{\sin^4 t - \cos^4 t}{\sin^2 t - \cos^2 t} = \frac{(\sin^2 t - \cos^2 t)(\sin^2 t + \cos^2 t)}{\sin^2 t - \cos^2 t} = \sin^2 t + \cos^2 t = 1.$$

$$7.7. \text{ a) } \sin t = \frac{4}{5}, \quad \frac{\pi}{2} < t < \pi, \quad \cos t = -\frac{3}{5}, \quad \operatorname{tg} t = -\frac{4}{3}, \quad \operatorname{ctg} t = -\frac{3}{4};$$

$$\text{б) } \sin t = \frac{5}{13}, \quad 0 < t < \frac{\pi}{2}, \quad \cos t = \sqrt{1 - \frac{25}{169}} = \frac{12}{13}, \quad \operatorname{tg} t = \frac{5}{12}, \quad \operatorname{ctg} t = \frac{12}{5};$$

$$\text{в) } \sin t = -0,6, \quad -\frac{\pi}{2} < t < 0, \quad \cos t = \frac{4}{5}, \quad \operatorname{tg} t = -\frac{3}{4}, \quad \operatorname{ctg} t = -\frac{4}{3};$$

$$\text{г) } \sin t = -0,28, \quad \pi < t < \frac{3\pi}{2},$$

$$\cos t = -\sqrt{1 - \frac{49}{625}} = -\frac{24}{25}, \quad \operatorname{tg} t = \frac{7}{24}, \quad \operatorname{ctg} t = \frac{24}{7}.$$

$$7.8. \text{ a) } \cos t = 0,8, \quad 0 < t < \frac{\pi}{2}, \quad \sin t = \frac{3}{5}, \quad \operatorname{tg} t = \frac{3}{4}, \quad \operatorname{ctg} t = \frac{4}{3};$$

$$\text{б) } \cos t = -\frac{5}{13}, \quad \frac{\pi}{2} < t < \pi, \quad \sin t = \frac{12}{13}, \quad \operatorname{tg} t = -\frac{12}{5}, \quad \operatorname{ctg} t = -\frac{5}{12};$$

$$\text{в) } \cos t = 0,6, \quad \frac{3\pi}{2} < t < 2\pi, \quad \sin t = -\frac{4}{5}, \quad \operatorname{tg} t = -\frac{4}{3}, \quad \operatorname{ctg} t = -\frac{3}{4};$$

$$\text{г) } \cos t = -\frac{24}{25}, \quad \pi < t < \frac{3\pi}{2}, \quad \sin t = -\frac{7}{25}, \quad \operatorname{tg} t = \frac{7}{24}, \quad \operatorname{ctg} t = \frac{24}{7}.$$

$$7.9. \text{ a) } \operatorname{tg} t = \frac{3}{4}, \quad 0 < t < \frac{\pi}{2}, \quad \operatorname{ctg} t = \frac{4}{3}, \quad \sin t = \frac{3}{5}, \quad \cos t = \frac{4}{5};$$

$$\text{б) } \operatorname{tg} t = 2,4, \quad \pi < t < \frac{3\pi}{2}, \quad \operatorname{ctg} t = \frac{5}{12}, \quad \cos t = -\frac{5}{13}, \quad \sin t = -\frac{12}{13};$$

$$в) \operatorname{tg} t = -\frac{3}{4}, \quad \frac{\pi}{2} < t < \pi, \quad \operatorname{ctg} t = -\frac{4}{3}, \quad \sin t = \frac{3}{5}, \quad \cos t = -\frac{4}{5};$$

$$г) \operatorname{tg} t = -\frac{5}{12}, \quad \frac{3\pi}{2} < t < 2\pi, \quad \operatorname{ctg} t = -\frac{12}{5}, \quad \sin t = -\frac{5}{13}, \quad \cos t = \frac{12}{13};$$

Во всех пунктах применяются формулы $1 + \operatorname{tg}^2 t = \frac{1}{\cos^2 t}$ и

$$1 + \operatorname{ctg}^2 t = \frac{1}{\sin^2 t}.$$

$$7.10. а) \operatorname{ctg} t = \frac{12}{5}, \quad \pi < t < \frac{3\pi}{2}, \quad \operatorname{tg} t = \frac{5}{12}, \quad \sin t = -\frac{5}{13}, \quad \cos t = -\frac{12}{13};$$

$$б) \operatorname{ctg} t = \frac{7}{24}, \quad 0 < t < \frac{\pi}{2}, \quad \operatorname{tg} t = \frac{24}{7}, \quad \sin t = \frac{24}{25}, \quad \cos t = \frac{7}{25};$$

$$в) \operatorname{ctg} t = -\frac{5}{12}, \quad \frac{3\pi}{2} < t < 2\pi, \quad \operatorname{tg} t = -\frac{12}{5}, \quad \cos t = \frac{5}{13}, \quad \sin t = -\frac{12}{13};$$

$$г) \operatorname{ctg} t = \frac{8}{15}, \quad \frac{\pi}{2} < t < \pi, \quad \operatorname{tg} t = -\frac{15}{8}, \quad \frac{\cos t}{\sqrt{1 - \cos^2 t}} = -\frac{8}{15},$$

$$\cos^2 t = \frac{64}{225} - \frac{64}{225} \cos^2 t, \quad \cos t = -\frac{8}{17}, \quad \sin t = \sqrt{1 - \frac{64}{289}} = \frac{15}{17}.$$

$$7.11. а) f(t) = 1 - (\cos^2 t - \sin^2 t) = 2\sin^2 t, \quad f_{\max} = 2, \quad f_{\min} = 0;$$

$$б) f(t) = 1 - \sin t \cdot \cos t \cdot \operatorname{tg} t = 1 - \sin t \cdot \cos t \cdot \frac{\sin t}{\cos t} = \cos^2 t, \quad f_{\max} = 1, \quad f_{\min} = 0.$$

$$в) f(t) = \cos^2 t \cdot \operatorname{tg}^2 t + 5 \cos^2 t - 1 = \cos^2 t \cdot \frac{\sin^2 t}{\cos^2 t} + 5 \cos^2 t - 1 = \sin^2 t + 5 \cos^2 t - 1 =$$

$$= 4 \cos^2 t, \quad f_{\max} = 4, \quad f_{\min} = 0.$$

$$г) f(t) = \sin t + 3 \sin^2 t + 3 \cos^2 t = \sin t + 3, \quad f_{\max} = 4, \quad f_{\min} = 2.$$

$$7.12. а) \operatorname{ctg} t - \frac{\cos t - 1}{\sin t} = \frac{\cos t - \cos t + 1}{\sin t} = \frac{1}{\sin t};$$

$$б) \operatorname{ctg}^2 t - \left(\frac{1}{\sin^2 t} - 1 \right) = \frac{\cos^2 t - 1 + \sin^2 t}{\sin^2 t} = 0;$$

$$в) \cos^2 t - (\operatorname{ctg}^2 t + 1) \sin^2 t = \cos^2 t - \cos^2 t - \sin^2 t = -\sin^2 t;$$

$$г) \frac{\sin^2 t - 1}{\cos^2 t - 1} + \operatorname{tg} t \cdot \operatorname{ctg} t = \operatorname{ctg}^2 t + 1 = \frac{\sin^2 t + \cos^2 t}{\sin^2 t} = \frac{1}{\sin^2 t}.$$

$$7.13. а) \frac{\sin t}{1 + \cos t} + \frac{\sin t}{1 - \cos t} = \frac{\sin t - \sin t \cos t + \sin t + \cos t \sin t}{1 - \cos^2 t} =$$

$$= \frac{2 \sin t}{\sin^2 t} = \frac{2}{\sin t};$$

$$б) \operatorname{ctg}^2 t (\cos^2 t - 1) + 1 = -\cos^2 t + 1 = \sin^2 t;$$

$$\begin{aligned} \text{b) } \frac{\cos t}{1 + \sin t} + \frac{\cos t}{1 - \sin t} &= \frac{\cos t - \sin t \cos t + \cos t + \sin t \cos t}{1 - \sin^2 t} = \\ &= \frac{2 \cos t}{\cos^2 t} = \frac{2}{\cos t}; \end{aligned}$$

$$\text{r) } \frac{\operatorname{tg} t + 1}{1 + \operatorname{ctg} t} = \frac{\frac{\sin t + \cos t}{\cos t}}{\frac{\sin t + \cos t}{\sin t}} = \operatorname{tg} t.$$

$$7.14. \text{ a) } \frac{1 - \sin^2 t}{1 - \cos^2 t} + \operatorname{tg} t \cdot \operatorname{ctg} t = \frac{\cos^2 t}{\sin^2 t} + 1 = \operatorname{ctg}^2 t + 1 = \frac{1}{\sin^2 t};$$

$$\begin{aligned} \text{b) } \frac{\cos^2 t - \operatorname{ctg}^2 t}{\sin^2 t - \operatorname{tg}^2 t} &= \frac{\frac{\cos^2 t \cdot \sin^2 t - \cos^2 t}{\sin^2 t}}{\frac{\sin^2 t \cdot \cos^2 t - \sin^2 t}{\cos^2 t}} = \frac{\cos^2 t (\sin^2 t - 1) \cos^2 t}{\sin^2 t \sin^2 t (\cos^2 t - 1)} = \\ &= \frac{-\cos^6 t}{-\sin^6 t} = \operatorname{ctg}^6 t \end{aligned}$$

$$7.15. \text{ a) } 1 + \sin t = \frac{\cos t + \operatorname{ctg} t}{\operatorname{ctg} t},$$

$$\frac{\cos t + \operatorname{ctg} t}{\operatorname{ctg} t} = \cos t - \operatorname{tg} t + 1 = \sin t + 1;$$

$$\text{b) } \frac{\sin t + \operatorname{tg} t}{\operatorname{tg} t} = 1 + \cos t, \quad \sin t \cdot \frac{\cos t}{\sin t} + 1 = \cos t + 1;$$

$$\text{b) } \frac{1 - \sin t}{\cos t} = \frac{\cos t}{1 + \sin t}, \quad \frac{1 - \sin^2 t}{\cos t (1 + \sin t)} = \frac{\cos t}{1 + \sin t};$$

$$\text{r) } \frac{\sin t}{1 - \cos t} = \frac{1 + \cos t}{\sin t}, \quad \frac{\sin t (1 + \cos t)}{1 - \cos^2 t} = \frac{1 + \cos t}{\sin t}.$$

$$7.16. \text{ a) } \frac{(\sin t + \cos t)^2 - 1}{\operatorname{ctg} t - \sin t \cos t} = 2 \operatorname{tg}^2 t,$$

$$\frac{2 \sin t \cos t}{\cos t - \sin^2 t \cos t} \sin t = \frac{2 \sin^2 t \cos t}{\cos t (1 - \sin^2 t)} = 2 \operatorname{tg}^2 t.$$

$$\text{b) } \sin^3 t (1 + \operatorname{ctg} t) + \cos^3 t (1 + \operatorname{tg} t) = \sin t + \cos t,$$

$$\begin{aligned} \sin^3 t \cdot \frac{\sin t + \cos t}{\sin t} + \cos^3 t \cdot \frac{\sin t + \cos t}{\cos t} &= \\ = (\sin t + \cos t) (\sin^2 t + \cos^2 t) &= \sin t + \cos t. \end{aligned}$$

$$7.17. \text{ a) } \sin(4\pi + t) = \frac{3}{5}, \quad 0 < t < \frac{\pi}{2},$$

$$\cos t = \frac{4}{5}, \quad \operatorname{tg} t = \frac{3}{4}, \quad \operatorname{tg}(-t) = -\frac{3}{4}, \quad \operatorname{tg}(\pi - t) = -\frac{3}{4};$$

$$6) \cos(2\pi + t) = \frac{12}{13}, \quad \frac{3\pi}{2} < t < 2\pi,$$

$$\sin t = -\frac{5}{13}, \quad \operatorname{ctg} t = -\frac{12}{5}, \quad \operatorname{ctg}(-t) = \frac{12}{5}, \quad \operatorname{ctg}(\pi - t) = \frac{12}{5}.$$

$$7.18. a) \cos t = -\frac{5}{13}, \quad 8,5\pi < t < 9\pi, \quad \sin t = \frac{12}{13}, \quad \sin(-t) = -\frac{12}{13};$$

$$6) \sin t = \frac{4}{5}, \quad \frac{9\pi}{2} < t < 5\pi,$$

$$\cos t = -\frac{3}{5}, \quad \cos(-t) = -\frac{3}{5},$$

$$\sin(-t) = -\frac{4}{5}, \quad \cos(-t) + \sin(-t) = -\frac{7}{5}.$$

$$7.19. \operatorname{tg} t - \frac{1}{\operatorname{tg} t} = -\frac{7}{12}, \quad 0 < t < \frac{\pi}{2}, \quad 12 \operatorname{tg}^2 t + 7 \operatorname{tg} t - 12 = 0,$$

$$\operatorname{tg} t = \frac{-7 \pm \sqrt{49 - 4 \cdot 12 \cdot (-12)}}{24} = \frac{-7 \pm 25}{24}, \quad \operatorname{tg} t = -\frac{4}{3} \text{ не подходит, т.к. } 0 < t < \frac{\pi}{2},$$

$$\operatorname{tg} t = \frac{3}{4} \Rightarrow \cos t = \frac{4}{5}, \quad \sin t = \frac{3}{5} \Rightarrow \sin t + \cos t = \frac{7}{5}.$$

$$7.20. a) y = \cos^2 t + \sin^2 t = 1;$$

$$6) y = \cos^2 \frac{1}{x} + \sin^2 \frac{1}{x} = 1 \quad (x \neq 0)$$

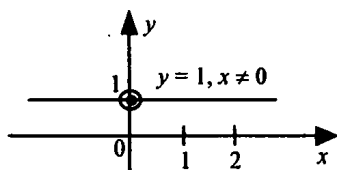
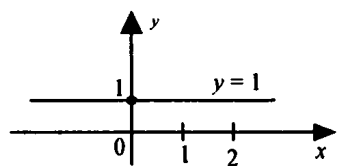

$$b) y = \sin^2 \sqrt{x} + \cos^2 \sqrt{x} = 1 \quad (x \geq 0)$$

$$r) y = \sin^2 \frac{1}{x^2 - 4} + \cos^2 \frac{1}{x^2 - 4} =$$

$$= 1 \quad (x \neq \pm 2)$$

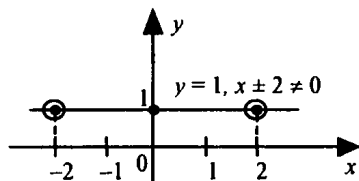
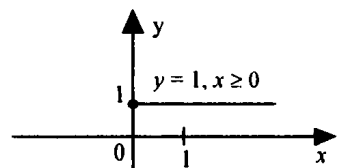

§ 8. Тригонометрические функции углового аргумента

8.1 – 8.4 см. рис.

8.1. а) $120^\circ = \frac{2\pi}{3}$; б) $220^\circ = \frac{11\pi}{9}$;

в) $300^\circ = \frac{5\pi}{3}$; г) $765^\circ = \frac{17\pi}{4}$.

8.2. а) $210^\circ = \frac{7\pi}{6}$; б) $150^\circ = \frac{5\pi}{6}$;

в) $330^\circ = \frac{11\pi}{6}$; г) $675^\circ = \frac{15\pi}{4}$.

8.3. а) $\frac{3\pi}{4} = 135^\circ$; б) $\frac{11\pi}{3} = 660^\circ$;

в) $\frac{6\pi}{5} = 216^\circ$; г) $\frac{46\pi}{9} = 920^\circ$.

8.4. а) $\frac{5\pi}{8} = 112,5^\circ$; б) $\frac{7\pi}{12} = 105^\circ$; в) $\frac{11\pi}{12} = 165^\circ$; г) $\frac{47\pi}{9} = 940^\circ$.

8.5. а) $\sin 90^\circ = 1$, $\cos 90^\circ = 0$, $\operatorname{tg} 90^\circ = \text{не суш.}$, $\operatorname{ctg} 90^\circ = 0$

б) $\sin 180^\circ = 0$, $\cos 180^\circ = -1$, $\operatorname{tg} 180^\circ = 0$, $\operatorname{ctg} 180^\circ = \text{не суш.}$

в) $\sin 270^\circ = -1$, $\cos 270^\circ = 0$, $\operatorname{tg} 270^\circ = \text{не суш.}$, $\operatorname{ctg} 270^\circ = 0$

г) $\sin 360^\circ = 0$, $\cos 360^\circ = 1$, $\operatorname{tg} 360^\circ = 0$, $\operatorname{ctg} 360^\circ = \text{не суш.}$

8.6. а) $\sin 30^\circ = \frac{1}{2}$, $\cos 30^\circ = \frac{\sqrt{3}}{2}$, $\operatorname{tg} 30^\circ = \frac{\sqrt{3}}{3}$, $\operatorname{ctg} 30^\circ = \sqrt{3}$;

б) $\sin 150^\circ = \frac{1}{2}$, $\cos 150^\circ = -\frac{\sqrt{3}}{2}$, $\operatorname{tg} 150^\circ = -\frac{\sqrt{3}}{3}$, $\operatorname{ctg} 150^\circ = -\sqrt{3}$;

в) $\sin 210^\circ = -\frac{1}{2}$, $\cos 210^\circ = -\frac{\sqrt{3}}{2}$, $\operatorname{tg} 210^\circ = \frac{\sqrt{3}}{3}$, $\operatorname{ctg} 210^\circ = \sqrt{3}$;

г) $\sin 240^\circ = -\frac{\sqrt{3}}{2}$, $\cos 240^\circ = -\frac{1}{2}$, $\operatorname{tg} 240^\circ = \sqrt{3}$, $\operatorname{ctg} 240^\circ = \frac{\sqrt{3}}{3}$.

8.7. $\sin 160^\circ$, $\sin 40^\circ$, $\sin 120^\circ$, $\sin 80^\circ$

8.8. $\cos 160^\circ$, $\cos 120^\circ$, $\cos 80^\circ$, $\cos 40^\circ$

8.9. $\sin 210^\circ$, $\sin 20^\circ$, $\sin 400^\circ$, $\sin 110^\circ$

8.10. а) $\operatorname{tg} \alpha = \frac{x}{2}$, $x = 2 \operatorname{tg} \alpha$;

б) $\cos \alpha = \frac{x}{4}$, $x = 4 \cos \alpha$;

в) $\cos \alpha = \frac{3}{x}$, $x = \frac{3}{\cos \alpha}$;

г) $\operatorname{ctg} \alpha = x$.

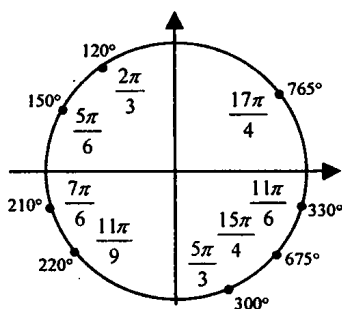

$$8.11. \text{ а) } \sin 30^\circ = \frac{2}{x}, x = \frac{2}{\frac{1}{2}} = 4; \quad \text{б) } x = \frac{\sqrt{2}}{2};$$

$$\text{в) } x = \frac{2}{\sin 60^\circ} = \frac{4}{\sqrt{3}}; \quad \text{г) } \frac{x}{2} = \cos 60^\circ = \frac{1}{2}, x = 1.$$

$$8.12. \text{ Во всех пунктах } a = c \cos \alpha, b = c \sin \alpha, S = \frac{1}{2} ab, R = \frac{c}{2}$$

$$\text{а) } c = 12, \alpha = 60^\circ, a = 6, b = 6\sqrt{3}, S = 18\sqrt{3}, R = 6;$$

$$\text{б) } c = 6, \alpha = 45^\circ, a = b = 3\sqrt{2}, S = 9, R = 3;$$

$$\text{в) } c = 4, \alpha = 30^\circ, a = 2\sqrt{3}, b = 2, S = 2\sqrt{3}, R = 2;$$

$$\text{г) } c = 60, \alpha = 60^\circ, a = 30, b = 30\sqrt{3}, S = 450\sqrt{3}, R = 30.$$

$$8.13. \cos \alpha = \frac{AB}{AC},$$

$$AB = AC \cdot \cos \alpha = 2R \cos \alpha.$$

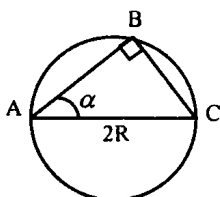

$$8.14. S_{ABCD} = \frac{1}{2} ab \sin \alpha + \frac{1}{2} bc \sin \alpha +$$

$$+ \frac{1}{2} cd \sin \alpha + \frac{1}{2} da \sin \alpha =$$

$$= \frac{1}{2} \sin \alpha (ab + bc + cd + da) =$$

$$= \frac{1}{2} \sin \alpha (b(a+c) + d(c+a)) =$$

$$= \frac{1}{2} \sin \alpha (b+d)(a+c), \text{ ч.т.д.}$$

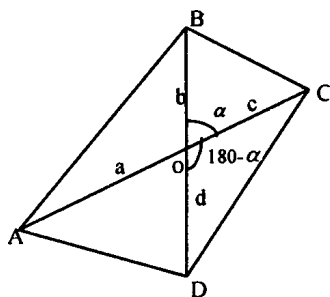

$$8.15. \frac{AB}{\sin C} = \frac{BC}{\sin A}, \frac{4\sqrt{2}}{1/2} = \frac{BC}{\sqrt{2}/2} \Rightarrow BC = 8,$$

$$\angle B = 180^\circ - 45^\circ - 30^\circ = 105^\circ,$$

$$AC = 4\sqrt{2} \cdot \cos 45^\circ + 8 \cos 30^\circ = 4 + 4\sqrt{3}.$$

$$S = \frac{1}{2} \cdot AC \cdot AB \cdot \sin \angle C;$$

$$S = \frac{1}{2} \cdot \frac{1}{2} (4\sqrt{3} + 4) 8 = 8(\sqrt{3} + 1).$$

$$\text{Ответ: } BC = 8, AC = 4\sqrt{3} + 4, S = 8(\sqrt{3} + 1) \text{ (см}^2\text{)}.$$

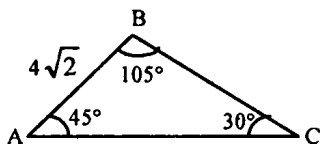

8.16. $AH = BH = 5$ (т.к. $\angle A = \angle ABH = 45^\circ$)

$$\operatorname{tg} 60^\circ = \frac{5}{HC}, \quad HC = \frac{5}{\operatorname{tg} 60^\circ} = \frac{5}{\sqrt{3}};$$

$$S = \frac{1}{2} \cdot 5 \cdot \left(5 + \frac{5}{\sqrt{3}}\right) = \frac{25(3 + \sqrt{3})}{6}$$

Ответ: $\frac{25(3 + \sqrt{3})}{6}$ (см²).

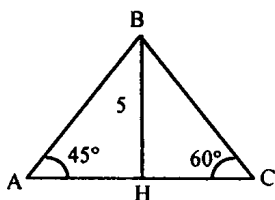

§ 9. Формулы приведения

9.1. а) $\sin\left(\frac{\pi}{2} - t\right) = \cos t$;

б) $\cos(2\pi - t) = \cos t$;

в) $\cos\left(\frac{3\pi}{2} + t\right) = -\sin t$;

г) $\sin(\pi + t) = -\sin t$.

9.2. а) $\sin(\pi - t) = \sin t$;

б) $\cos\left(\frac{\pi}{2} + t\right) = -\sin t$;

в) $\cos(2\pi + t) = \cos t$;

г) $\sin\left(\frac{3\pi}{2} - t\right) = -\cos t$.

9.3. а) $\cos(90^\circ - \alpha) = \sin \alpha$;

б) $\sin(360^\circ - \alpha) = -\sin \alpha$;

в) $\sin(270^\circ + \alpha) = -\cos \alpha$;

г) $\cos(180^\circ + \alpha) = -\cos \alpha$.

9.4. а) $\operatorname{tg}(90^\circ - \alpha) = \operatorname{ctg} \alpha$;

б) $\operatorname{ctg}(180^\circ - \alpha) = -\operatorname{ctg} \alpha$;

в) $\operatorname{tg}(270^\circ + \alpha) = -\operatorname{ctg} \alpha$;

г) $\operatorname{ctg}(360^\circ + \alpha) = \operatorname{ctg} \alpha$.

9.5. а) $\sin 240^\circ = -\sin 60^\circ = -\frac{\sqrt{3}}{2}$;

б) $\operatorname{tg} 300^\circ = \operatorname{tg} 120^\circ = -\operatorname{tg} 60^\circ = -\sqrt{3}$;

в) $\cos 330^\circ = \cos(-30^\circ) = \frac{\sqrt{3}}{2}$;

г) $\operatorname{ctg} 315^\circ = -\operatorname{ctg} 45^\circ = -1$.

9.6. а) $\cos \frac{5\pi}{3} = \frac{1}{2}$;

б) $\sin\left(-\frac{11\pi}{6}\right) = \frac{1}{2}$;

в) $\sin \frac{7\pi}{6} = -\frac{1}{2}$;

г) $\cos\left(-\frac{7\pi}{3}\right) = \frac{1}{2}$.

9.7. а) $\cos 630^\circ - \sin 1470^\circ - \operatorname{ctg} 1125^\circ = -\frac{1}{2} - 1 = -\frac{3}{2}$;

б) $\sin(-7\pi) + 2 \cos \frac{31\pi}{3} - \operatorname{tg} \frac{7\pi}{4} = 1 + 1 = 2$;

в) $\operatorname{tg} 1800^\circ - \sin 495^\circ + \cos 945^\circ = -\frac{\sqrt{2}}{2} - \frac{\sqrt{2}}{2} = -\sqrt{2}$;

г) $\cos(-9\pi) + 2 \sin\left(-\frac{49\pi}{6}\right) - \operatorname{ctg}\left(-\frac{21\pi}{4}\right) = -1 - 1 + 1 = -1$.

$$9.8. \text{ a) } \sin(90^\circ - \alpha) + \cos(180^\circ + \alpha) + \operatorname{tg}(270^\circ + \alpha) + \operatorname{ctg}(360^\circ + \alpha) = \\ = \cos \alpha - \cos \alpha - \operatorname{ctg} \alpha + \operatorname{ctg} \alpha = 0;$$

$$\text{б) } \sin\left(\frac{\pi}{2} + t\right) - \cos(\pi - t) + \operatorname{tg}(\pi - t) + \operatorname{ctg}\left(\frac{5\pi}{2} - t\right) = \\ = \cos t + \cos t - \operatorname{tg} t + \operatorname{tg} t = 2 \cos t.$$

$$9.9. \text{ a) } \frac{\cos(180 + \alpha) \cdot \cos(-\alpha)}{\sin(-\alpha) \cdot \sin(90 + \alpha)} = \frac{-\cos \alpha \cos \alpha}{-\sin \alpha \cos \alpha} = \operatorname{ctg} \alpha;$$

$$\text{б) } \frac{\sin(\pi - t) \cos(2\pi - t)}{\operatorname{tg}(\pi - t) \cos(\pi - t)} = \frac{\sin t \cos t}{-\operatorname{tg} t \cdot (-\cos t)} = \cos t;$$

$$\text{в) } \frac{\sin(-\alpha) \operatorname{ctg}(-\alpha)}{\cos(360 - \alpha) \operatorname{tg}(180 + \alpha)} = \frac{\cos \alpha}{\cos \alpha \operatorname{tg} \alpha} = \operatorname{ctg} \alpha;$$

$$\text{г) } \frac{\sin(\pi + t) \sin(2\pi + t)}{\operatorname{tg}(\pi + t) \cos\left(\frac{3\pi}{2} + t\right)} = \frac{-\sin t \sin t}{\frac{\sin t}{\cos t} \cdot \sin t} = -\cos t.$$

$$9.10. \text{ a) } \frac{\cos(\pi - t) + \cos\left(\frac{\pi}{2} - t\right)}{\sin(2\pi - t) - \sin\left(\frac{3\pi}{2} - t\right)} = \frac{-\cos t + \sin t}{-\sin t + \cos t} = -1;$$

$$\text{б) } \frac{\sin^2(\pi - t) + \sin^2\left(\frac{\pi}{2} - t\right)}{\sin(\pi - t)} \operatorname{tg}(\pi - t) = \frac{\sin^2 t + \cos^2 t}{\sin t} \cdot \left(-\frac{\sin t}{\cos t}\right) = -\frac{1}{\cos t};$$

$$9.11. \text{ a) } \frac{\operatorname{tg}(\pi - t)}{\cos(\pi + t)} \cdot \frac{\sin\left(\frac{3\pi}{2} + t\right)}{\operatorname{tg}\left(\frac{3\pi}{2} + t\right)} = \operatorname{tg}^2 t, \quad \frac{-\operatorname{tg} t}{-\cos t} \cos\left(\frac{3\pi}{2} + t\right) = \operatorname{tg}^2 t;$$

$$\text{б) } \frac{\sin(\pi - t)}{\operatorname{tg}(\pi + t)} \cdot \frac{\operatorname{ctg}\left(\frac{\pi}{2} - t\right)}{\operatorname{tg}\left(\frac{\pi}{2} + t\right)} \cdot \frac{\cos(2\pi - t)}{\sin(-t)} = \sin t.$$

$$\frac{\sin t}{\operatorname{tg} t} \cdot \frac{\operatorname{tg} t}{-\operatorname{ctg} t} \cdot \frac{\cos t}{-\sin t} = \operatorname{tg} t \cos t = \sin t.$$

$$9.12. \text{ a) } 2 \cos(2\pi + t) + \sin\left(\frac{\pi}{2} + t\right) = 3,$$

$$2 \cos t + \cos t = 3, \quad \cos t = 1, \quad t = 2\pi n;$$

$$\text{б) } \sin(\pi + t) + 2 \cos\left(\frac{\pi}{2} + t\right) = 3,$$

$$-\sin t - 2 \sin t = 3, \quad \sin t = -1, \quad t = -\frac{\pi}{2} + 2\pi n;$$

$$в) 2\sin(\pi+t)+\cos\left(\frac{\pi}{2}-t\right)=-\frac{1}{2}, \quad -2\sin t+\sin t=-\frac{1}{2}, \quad \sin t=\frac{1}{2}, \quad t=(-1)^k \frac{\pi}{6} + \pi k;$$

$$г) 3\sin\left(\frac{\pi}{2}+t\right)-\cos(2\pi+t)=1, \quad 3\cos t-\cos t=1, \quad \cos t=\frac{1}{2}, \quad t=\pm\frac{\pi}{3}+2\pi n.$$

$$9.13. а) 5\sin\left(\frac{\pi}{2}+t\right)-\sin\left(\frac{3\pi}{2}+t\right)-8\cos(2\pi-t)=1, \quad 5\cos t+\cos t-8\cos t=$$

$$=1, \quad \cos t=-\frac{1}{2}, \quad t=\pm\frac{2\pi}{3}+2\pi n;$$

$$б) \sin(2\pi+t)-\cos\left(\frac{\pi}{2}-t\right)+\sin(\pi-t)=1, \quad \sin t-\sin t+\sin t=1, \quad \sin t=1,$$

$$t=\frac{\pi}{2}+2\pi n.$$

$$9.14. а) \sin^2(\pi+t)+\cos^2(2\pi-t)=0, \quad \sin^2 t+\cos^2 t=0 \quad \text{корней нет;}$$

$$б) \sin^2(\pi+t)+\cos^2(2\pi-t)=1, \quad \sin^2 t+\cos^2(2\pi-t)=1, \quad \sin^2 t+\cos^2 t=1, \quad t \in \mathbb{R}.$$

§ 10. Функция $y = \sin x$, её свойства и график

$$10.1. а) \sin \pi = 0; \quad б) \sin\left(-\frac{\pi}{2}\right) = -1;$$

$$в) \sin \frac{2\pi}{3} = \frac{\sqrt{3}}{2}; \quad г) \sin\left(-\frac{\pi}{3}\right) = -\frac{\sqrt{3}}{2}.$$

$$10.2. а) f(x) = \sin x, \quad f(-x) = -\sin x; \quad б) f(x) = \sin x, \quad f(2x) = \sin 2x;$$

$$в) f(x) = \sin x, \quad f(x+1) = \sin(x+1); \quad г) f(x) = \sin x, \quad f(x)-5 = \sin x-5.$$

$$10.3. а) y = 2\sin\left(x - \frac{\pi}{6}\right) + 1, \quad x = \frac{4\pi}{3}, \quad y = 2\sin\frac{7\pi}{6} + 1 = -1 + 1 = 0;$$

$$б) y = -\sin\left(x + \frac{\pi}{4}\right), \quad x = -\frac{\pi}{2}, \quad y = -\sin\left(-\frac{\pi}{4}\right) = \frac{\sqrt{2}}{2};$$

$$в) y = 2\sin\left(x - \frac{\pi}{6}\right) + 1, \quad x = \frac{7\pi}{6}, \quad y = 2\sin\pi + 1 = 1;$$

$$г) y = -\sin\left(x + \frac{\pi}{4}\right), \quad x = -\frac{15\pi}{4}, \quad y = -\sin\left(-\frac{14\pi}{4}\right) = \sin\frac{7\pi}{2} = -1.$$

$$10.4. а) y = \sin x, \quad \sin\left(-\frac{\pi}{2}\right) = -1, \quad \left(-\frac{\pi}{2}; -1\right) \text{ принадлежит;}$$

$$б) y = \sin x, \quad \frac{1}{2} \neq \sin\frac{\pi}{2}, \quad \left(\frac{\pi}{2}; \frac{1}{2}\right) \text{ не принадлежит;}$$

$$в) y = \sin x, \quad 1 \neq \sin\pi, \quad (\pi; 1) \text{ не принадлежит.}$$

$$г) y = \sin x, \quad -1 = \sin\frac{3\pi}{2}, \quad \left(\frac{3\pi}{2}; -1\right) \text{ принадлежит.}$$

10.5. а) $y = \sin(x + \frac{\pi}{6}) + 2 = -\sin \frac{\pi}{6} + 2 = \frac{3}{2}$, $(0; \frac{3}{2})$ принадлежит;

б) $y = -\sin(x + \frac{\pi}{6}) + 2 = -\sin \frac{\pi}{3} + 2 = -\frac{\sqrt{3}}{2} + 2$,

$(\frac{\pi}{6}; -\frac{\sqrt{3}}{2} + 2)$ принадлежит;

в) $y = -\sin(x + \frac{\pi}{6}) + 2$, $\frac{3}{2} = -\sin \frac{5\pi}{6} + 2 = -\frac{1}{2} + 2$,

$(\frac{2\pi}{3}; \frac{3}{2})$ принадлежит;

г) $y = -\sin(x + \frac{\pi}{6}) + 2$, $-\sin(4\pi + \frac{\pi}{6}) + 2 = -\frac{1}{2} + 2 \neq 2,5$,

$(4\pi; 2,5)$ не принадлежит.

10.6. а) $y = \sin x$, $x \in [\frac{\pi}{4}; \frac{2\pi}{3}]$, $f_{\max} = 1$, $f_{\min} = \frac{\sqrt{2}}{2}$;

б) $y = \sin x$, $x \in [\frac{\pi}{4}; +\infty)$, $f_{\max} = 1$, $f_{\min} = -1$;

в) $y = \sin x$, $x \in (-\frac{3\pi}{2}; \frac{3\pi}{4})$, $f_{\max} = 1$, $f_{\min} = -1$;

г) $y = \sin x$, $x \in (-\pi; \frac{\pi}{3}]$, $f_{\max} = \frac{\sqrt{3}}{2}$, $f_{\min} = -1$

10.7. а)

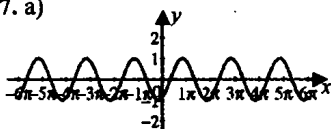

б)

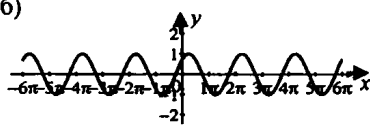

в)

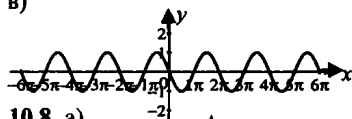

г)

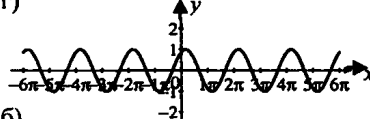

10.8. а)

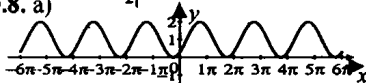

б)

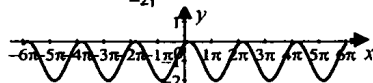

10.9.

а)

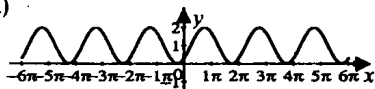

б)

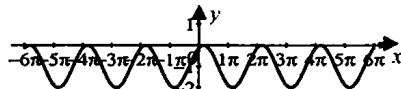

10.10. a)

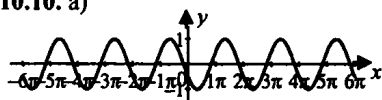

б)

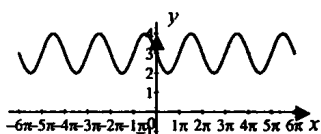

10.11. a) $\sin x = x + \pi$, $x = -\pi$;

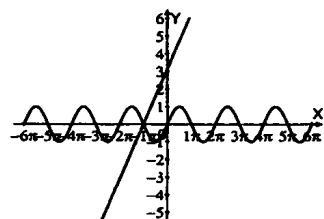

б) $\sin x = 2x$, $x = 0$;

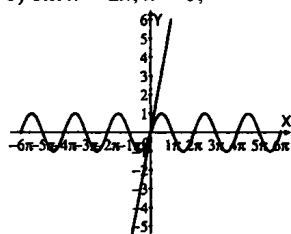

в) $\sin x = -x$, $x = 0$;

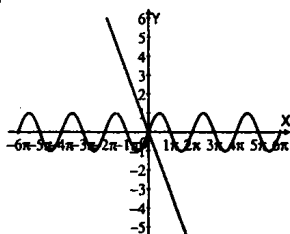

г) $\sin x = 2x - 2\pi$, $x = \pi$

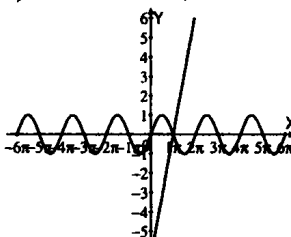

10.12. а) $\sin x = \frac{2}{\pi} x$, $x = 0$, $x = \pm \frac{\pi}{2}$; б) $\sin x = -\frac{4}{\pi} x + 3$, $x = \frac{\pi}{2}$.

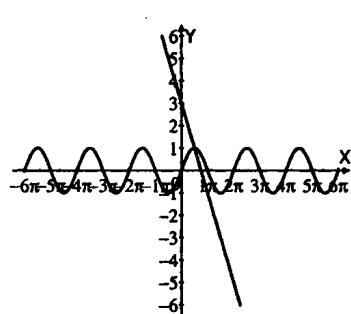
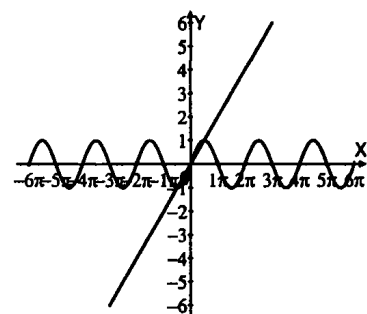

10.13.

а) $\sin x = \sqrt{x - \pi}$, $x = \pi$.

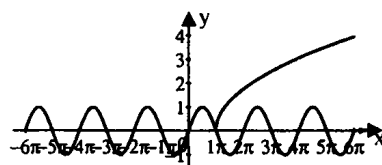

б) $-\sin x = \sqrt{x}$, $x = 0$.

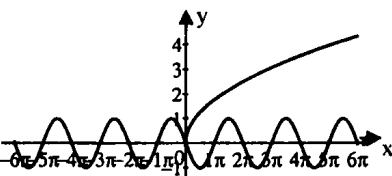

10.14. а) $f(x) = x + \sin x$,

$f(-x) = (-x) + \sin(-x) = -(x + \sin x) = -f(x)$;

б) $f(x) = x^3 \sin x^2$,

$f(-x) = -x^3 \cdot \sin(-x)^2 = -x^3 \sin x^2 = -f(x)$;

в) $f(x) = \frac{x^2 \sin x}{x^2 - 9}$, $f(-x) = -\frac{x^2 \sin x}{x^2 - 9} = -f(x)$;

г) $f(x) = x^3 - \sin x$, $f(-x) = -x^3 + \sin x = -f(x)$.

10.15. $f(x) = 2x^2 - x + 1$.

$f(\sin x) = 2 \sin^2 x - \sin x + 1 = 2 - 2 \cos^2 x - \sin x + 1 = 3 - 2 \cos^2 x - \sin x$.

10.16.

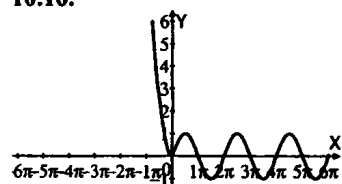

10.17. $f(x) = \begin{cases} \sin x, & -\pi \leq x \leq 0 \\ \sqrt{x}, & x > 0 \end{cases}$

а) $f(-\frac{\pi}{2}) = \sin(-\frac{\pi}{2}) = -1$, $f(0) = 0$, $f(1) = 1$, $f(\pi^2) = \pi$

б)

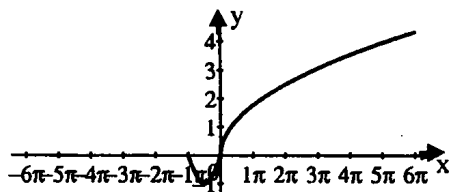

в)

1) $D(f) = [-\pi; +\infty)$;

2) $E(f) = [-1; +\infty)$;

3) неперіодична;

4) ни четная, ни нечетная;

5) $f(x) = 0$ при $x = 0$, $x = -\pi$;

6) $f(x) > 0$ при $x > 0$, $f(x) < 0$ при $x \in (-\pi; 0)$;

7) $f_{\min} = -1$, $f_{\max} = +\infty$;

8) убывает при $x \in [-\pi; -\frac{\pi}{2}]$, возрастает при $x \geq -\frac{\pi}{2}$.

10.18. $f(x) = \begin{cases} \frac{1}{x}, & x < 0 \\ \sin x, & 0 \leq x \leq \pi \end{cases}$

а) $f(-2) = -\frac{1}{2}$, $f(0) = 0$, $f(1) = \sin 1$;

б)

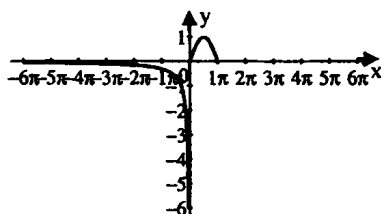

в)

1) $D(f) = (-\infty; \pi]$; 2) $E(f) = (-\infty; +1]$;

3) неперiodичная;

4) ни четная, ни нечетная;

5) $f(x) = 0$ при $x = 0, x = \pi$;

6) $f(x) < 0$ при $x < 0, f(x) > 0$ при $x \in (0; \pi)$;

7) $f_{\min} = -\infty, f_{\max} = 1$;

8) убывает при $x < 0, x \in \left[\frac{\pi}{2}; \pi\right]$, возрастает при $x \in \left[0; \frac{\pi}{2}\right]$.

§ 11. Функция $y = \cos x$, ее свойства и график

11.1. а) $\cos \frac{\pi}{2} = 0$;

б) $\cos(-\pi) = -1$;

в) $\cos \frac{5\pi}{6} = -\frac{\sqrt{3}}{2}$;

г) $\cos\left(-\frac{2\pi}{3}\right) = -\frac{1}{2}$.

11.2. а) $f(x) = \cos x, f(-x) = \cos x$;

б) $f(x) = \cos x, f(3x) = \cos 3x$;

в) $f(x) = \cos x, f(x+2) = \cos(x+2)$;

г) $f(x) = \cos x, f(x) - 6 = \cos x - 6$.

11.3. а) $y = 2 \sin\left(-\frac{\pi}{2}\right) + \cos\left(-\frac{\pi}{2}\right) = -2$;

б) $y = 2 \sin \frac{\pi}{6} + \cos \frac{\pi}{6} = 1 + \frac{\sqrt{3}}{2}$.

11.4. а) $y = 2 \cos\left(-\frac{\pi}{2} - \frac{\pi}{4}\right) - 1 = -\sqrt{2} - 1$;

б) $y = 2 \cos\left(\frac{\pi}{4} - \frac{\pi}{4}\right) - 1 = 1$.

11.5. а)

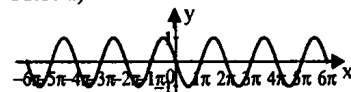

б)

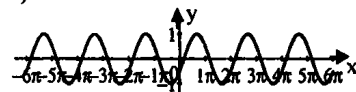

в)

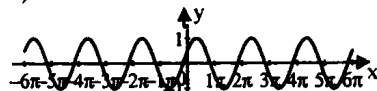

г)

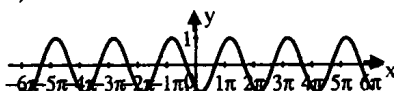

11.6. а)

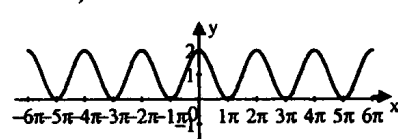

б)

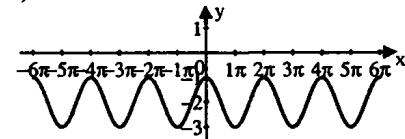

в)

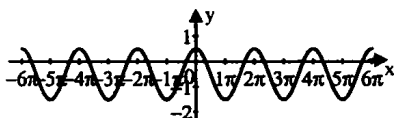

$$11.7. y = \cos x.$$

$$а) x \in \left[\frac{\pi}{6}; \frac{2\pi}{3} \right], y_{\min} = -\frac{1}{2}, y_{\max} = \frac{\sqrt{3}}{2}.$$

$$б) x \in \left(-\pi; \frac{\pi}{4}\right) y_{\min} = \text{не существует}, y_{\max} = 1.$$

$$в) x \in \left[-\frac{\pi}{3}; +\infty\right), y_{\min} = -1, y_{\max} = 1.$$

$$г) x \in \left[-\frac{\pi}{3}; \frac{3\pi}{2}\right), y_{\min} = -1, y_{\max} = 1.$$

$$11.8. а) f(x) = \begin{cases} x+2, & x < 0 \\ \cos x, & x \geq 0 \end{cases}$$

$$1) D(f) = \mathbb{R};$$

$$2) E(f) = (-\infty; 2];$$

$$3) \text{ при } x \geq 0 T = 2\pi;$$

4) ни четная, ни нечетная;

$$5) f(x) = 0 \text{ при } x = -2, x = \frac{\pi}{2} + \pi n, n \geq 0;$$

$$6) f(x) < 0 \text{ при } x \in (-\infty; -2) \cup \left(\frac{\pi}{2} + 2\pi n; \frac{3}{2}\pi + 2\pi n\right), n \geq 0, f(x) > 0 \text{ при}$$

$$x \in \left(-2; \frac{\pi}{2}\right) \cup \left(-\frac{\pi}{2} + 2\pi n; \frac{\pi}{2} + 2\pi n\right), n \geq 1;$$

$$7) f_{\min} = -\infty, f_{\max} = \text{не сущ.};$$

$$8) f(x) \text{ возрастает при } x \in (-\infty; 0) \cup [-\pi + 2\pi n; 2\pi n], n \geq 1,$$

$$\text{убывает при } x \in [2\pi n; 2\pi n + \pi], n \geq 0.$$

$$б) f(x) = \begin{cases} \cos x, & x \leq \frac{\pi}{2} \\ \sin x, & x > \frac{\pi}{2} \end{cases}$$

г)

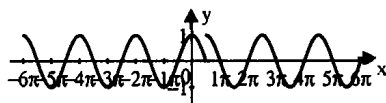
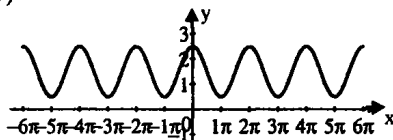

$$1) D(f) = \mathbb{R};$$

$$2) E(f) = [-1; 1];$$

$$3) \text{ на промежутках } \left(-\infty; \frac{\pi}{2}\right) \text{ и } \left(\frac{\pi}{2}; +\infty\right) T = 2\pi;$$

4) ни четная, ни нечетная;

5) $f(x) = 0$ при $x = \frac{\pi}{2} - \pi n, n \geq 0, x = \pi(1+k), k \geq 0$;

6) $f(x) > 0$ при $x \in \left(-\frac{\pi}{2} + 2\pi n; \frac{\pi}{2} + 2\pi n\right), n \leq 0, x \in \left(\frac{\pi}{2}, \pi\right), x \in (2\pi n; 2\pi n + \pi), n \geq 1$;

7) $f_{\min} = -1, f_{\max} = 1$;

8) $f(x)$ возрастает при $x \in [-\pi + 2\pi n; 2\pi n], n \leq 0, x \in \left[-\frac{\pi}{2} + 2\pi k; \frac{\pi}{2} + 2\pi k\right], k$

≥ 1 , убывает при $x \in [2\pi n; \pi + 2\pi n], n \leq -1, x \in \left[0; \frac{\pi}{2}\right]$;

$x \in \left[\frac{\pi}{2} + 2\pi k; \frac{3}{2}\pi + 2\pi k\right], k \geq 0$;

в) $f(x) = \begin{cases} -\frac{2}{x}, & x < 0 \\ -\cos x, & x \geq 0 \end{cases}$

1) $D(f) = \mathbb{R}$;

2) $E(f) = [-1; +\infty)$;

3) при $x \geq 0$ $T = 2\pi$;

4) ни четная, ни нечетная;

5) $f(x) = 0$ при $x = \frac{\pi}{2} + \pi n, n \geq 0$;

6) $f(x) < 0$ при $x \in \left[0; \frac{\pi}{2}\right) \cup \left(-\frac{\pi}{2} + 2\pi n; \frac{\pi}{2} + 2\pi n\right), n \geq 1$,

$f(x) > 0$ при $x \in (-\infty; 0) \cup \left(\frac{\pi}{2} + 2\pi n; \frac{3}{2}\pi + 2\pi n\right), n \geq 0$;

7) $f_{\min} = -1, f_{\max} = +\infty$;

8) $f(x)$ возрастает при $x \in (-\infty; 0) \cup [2\pi n; \pi + 2\pi n], n \geq 0$,
убывает при $x \in [2\pi k - \pi; 2\pi k], k \geq 1$.

г) $f(x) = \begin{cases} -\cos x, & x < 0 \\ 2x^2 - 1, & x \geq 0 \end{cases}$

1) $D(f) = \mathbb{R}$; 2) $E(f) = [-1; +\infty)$;

3) при $x < 0$ $T = 2\pi$;

4) ни четная, ни нечетная;

5) $f(x) = 0$ при $x = \frac{\pi}{2} - \pi n, n \geq 1, x = \frac{\sqrt{2}}{2}$;

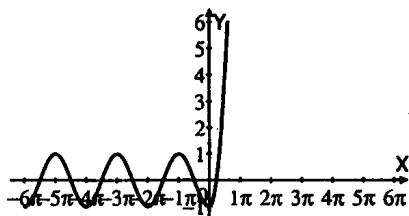
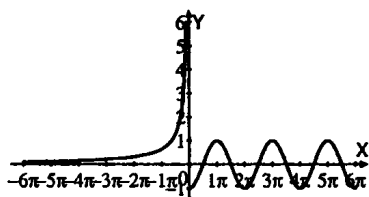

$$6) f(x) < 0 \text{ при } x \in \left(-\frac{\pi}{2} - 2\pi n; \frac{\pi}{2} - 2\pi n\right) \cup \left(-\frac{\pi}{2}; \frac{\sqrt{2}}{2}\right), n \geq 1,$$

$$f(x) > 0 \text{ при } x \in \left(\frac{\pi}{2} - 2\pi k; \frac{3}{2}\pi - 2\pi k\right) \cup \left(\frac{\sqrt{2}}{2}; +\infty\right), k \geq 1;$$

$$7) f_{\min} = -1, f_{\max} = +\infty;$$

$$8) f(x) \text{ возрастает при } x \in [-2\pi n; -2\pi n + \pi] \cup [0; +\infty), n \geq 1,$$

$$\text{убывает при } x \in [-2\pi n - \pi; -2\pi n], n \geq 0.$$

11.9.

$$a) \cos x = x + \frac{\pi}{2}; x = -\frac{\pi}{2}.$$

$$б) -\cos x = 3x - 1; x = 0.$$

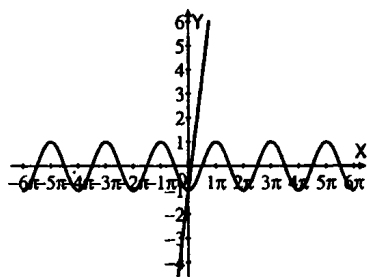
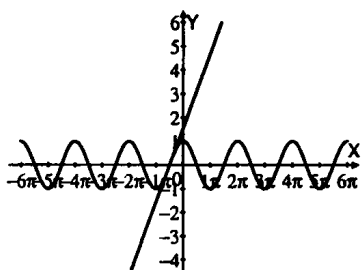

$$в) \cos x = 2x + 1; x = 0.$$

$$г) \cos x = -x + \frac{\pi}{2}; x = \frac{\pi}{2}.$$

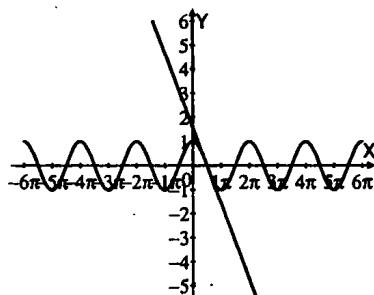
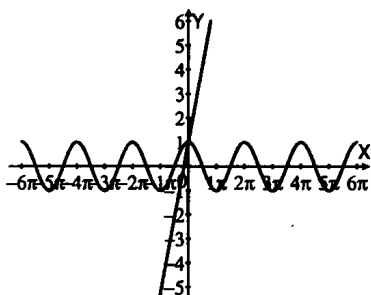

11.10.

$$a) \cos x = \sqrt{x} + 1, x = 0;$$

$$б) \cos x = \sqrt{x - \frac{\pi}{2}}, x = \frac{\pi}{2};$$

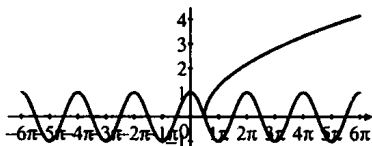
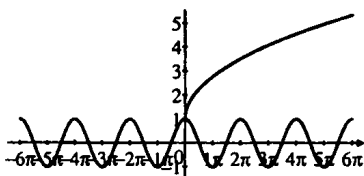

$$b) \cos x + 1 = -(x - \pi)^2; x = \pi$$

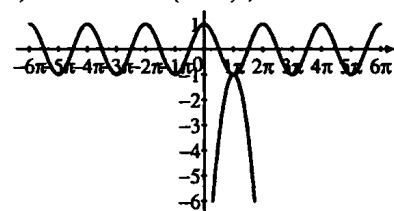

$$r) \cos x = |x| + 1, x = 0.$$

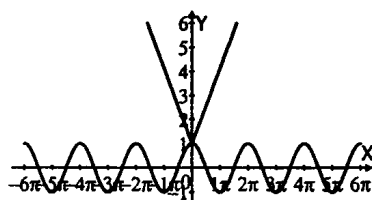

$$11.11. a) f(x) = x^2 \cos x, f(-x) = (-x)^2 \cos(-x) = x^2 \cos x = f(x);$$

$$b) f(x) = \frac{\cos x^3}{4 - x^2}, f(-x) = \frac{\cos(-x)^3}{4 - (-x)^2} = \frac{\cos x^3}{4 - x^2} = f(x);$$

$$b) f(x) = \frac{\cos 5x + 1}{|x|}, f(-x) = \frac{\cos(-5x) + 1}{|-x|} = \frac{\cos 5x + 1}{|x|} = f(x);$$

$$r) f(x) = (4 + \cos x)(\sin^6 x - 1),$$

$$f(-x) = (4 + \cos(-x))(\sin^6(-x) - 1) = (4 + \cos x)(\sin^6 x - 1) = f(x).$$

$$11.12. a) f(x) = \sin x \cos x, f(-x) = \sin(-x) \cos(-x) = -\sin x \cos x = -f(x);$$

$$b) f(x) = x^5 \cos 3x, f(-x) = (-x)^5 \cos(-3x) = -x^5 \cos 3x = -f(x);$$

$$b) f(x) = \frac{\cos x^3}{x(25 - x^2)}, f(-x) = \frac{\cos(-x)^3}{-x(25 - (-x)^2)} = -\frac{\cos x^3}{x(25 - x^2)} = -f(x);$$

$$r) f(x) = x^{11} \cdot \cos x + \sin x,$$

$$f(-x) = (-x)^{11} \cdot \cos(-x) + \sin(-x) = (-x)^{11} \cdot \cos x - \sin x = f(-x).$$

$$11.13. a) f(x) = 2x^2 - 3x - 2,$$

$$-f(\cos x) = -2 \cos^2 x + 3 \cos x + 2 = 2(1 - \cos^2 x) + 3 \cos x = 2 \sin^2 x + 3 \cos x$$

$$b) f(x) = 5x^2 + x + 4,$$

$$f(\cos x) = 5 \cos^2 x + \cos x + 4 = 5 - 5 \sin^2 x + \cos x + 4 = -5 \sin^2 x + \cos x + 9.$$

§ 12. Периодичность функций $y = \sin x$, $y = \cos x$

12.1.

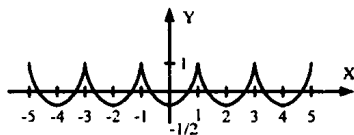

12.2.

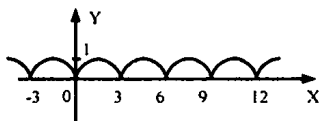

12.3.

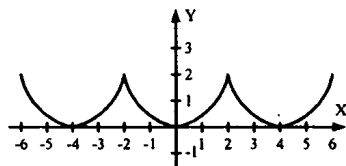

12.4.

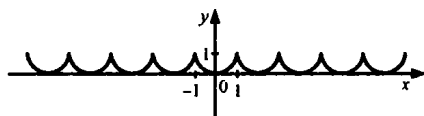

12.5. 32π является периодом функций $y = \sin x$, $y = \cos x$, но не основным.

12.6. а) $\sin 50, 5\pi = \sin \frac{\pi}{2} = 1$; б) $\cos 51, 75\pi = \cos \frac{7\pi}{4} = \frac{\sqrt{2}}{2}$;

в) $\sin 25, 25\pi = \sin \frac{5\pi}{4} = -\frac{\sqrt{2}}{2}$;

г) $\sin 29, 5\pi = \sin\left(30\pi - \frac{\pi}{2}\right) = -\sin \frac{\pi}{2} = -1$

12.7. а) $\sin 390^\circ = \sin 30^\circ = \frac{1}{2}$; б) $\cos 750^\circ = \cos 30^\circ = \frac{\sqrt{3}}{2}$;

в) $\sin 540^\circ = \sin 180^\circ = 0$; г) $\cos 930^\circ = \cos 210^\circ = -\frac{\sqrt{3}}{2}$.

12.8. а) $\sin^2(x - 8\pi) = 1 - \cos^2(16\pi - x)$, $\sin^2(x - 8\pi) = \sin^2 x$;
 $1 - \cos^2(16\pi - x) = 1 - \cos^2 x = \sin^2 x$;

б) $\cos^2(4\pi + x) = 1 - \sin^2 x (22\pi - x)$; $\cos^2(4\pi + x) = \cos^2 x$,
 $1 - \sin^2 x (22\pi - x) = 1 - \sin^2 x = \cos^2 x$.

12.9. а) $\sin(t + 2\pi) + \sin(t - 4\pi) = 1$, $\sin t + \sin t = 1$,

$\sin t = \frac{1}{2}$; $t = (-1)^k \frac{\pi}{6} + \pi k$;

б) $3 \cos(2\pi + t) + \cos(t - 2\pi) + 2 = 0$,

$4 \cos t = -2$, $\cos t = -\frac{1}{2}$, $t = \pm \frac{2\pi}{3} + 2\pi n$;

в) $\sin(t + 4\pi) + \sin(t - 6\pi) = \sqrt{3}$,

$2 \sin t = \sqrt{3}$, $\sin t = \frac{\sqrt{3}}{2}$, $t = (-1)^k \frac{\pi}{3} + \pi k$;

г) $\cos(t + 2\pi) + \cos(t - 8\pi) = \sqrt{2}$,

$2 \cos t = \sqrt{2}$, $\cos t = \frac{\sqrt{2}}{2}$, $t = \pm \frac{\pi}{4} + 2\pi k$.

§ 13. Преобразования графиков тригонометрических функций

13.1. а)

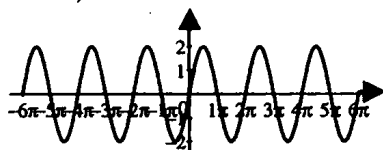

б)

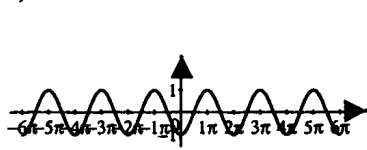

в)

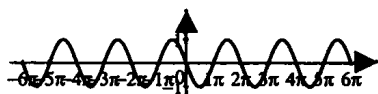

13.2. а)

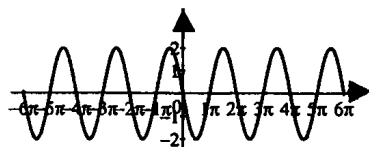

в)

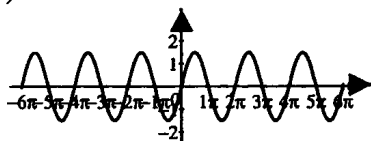

г)

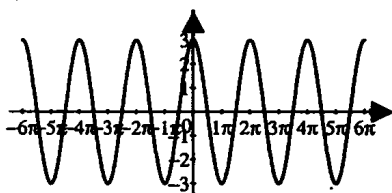

б)

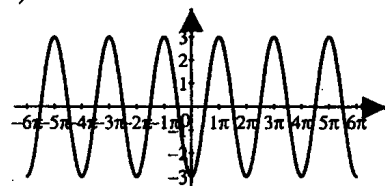

г)

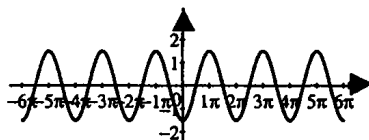
13.3. $y = 2 \cos x$

а) $x \in [-\frac{\pi}{2}; \frac{\pi}{2}]$, $y_{\max} = 2$, $y_{\min} = 0$;

б) $x \in (0; \frac{3\pi}{2})$, $y_{\min} = -2$, y_{\max} не существует.

в) $x \in [\frac{\pi}{3}; \frac{3\pi}{2})$, $y_{\max} = 1$, $y_{\min} = -2$;

г) $x \in [-\frac{3\pi}{2}; -\frac{\pi}{4}]$, $y_{\max} = \sqrt{2}$, $y_{\min} = -2$.

13.4. $y = -3 \sin x$;

а) $x \in [0; +\infty)$, $y_{\max} = 3$, $y_{\min} = -3$;

б) $x \in (-\infty; \frac{\pi}{2})$, $y_{\max} = 3$, $y_{\min} = -3$;

в) $x \in [\frac{\pi}{4}; +\infty)$, $y_{\max} = 3$, $y_{\min} = -3$;

г) $x \in (-\infty; 0)$, $y_{\max} = 3$, $y_{\min} = -3$.

13.5. $f(x) = 3 \sin x$;

а) $f(-x) = -3 \sin x$;

б) $2f(x) = 6 \sin x$;

в) $2f(x) + 1 = 6 \sin x + 1$;

г) $f(-x) + f(x) = -3 \sin x + 3 \sin x = 0$.

$$13.6. f(x) = -\frac{1}{2} \cos x;$$

$$a) f(-x) = -\frac{1}{2} \cos x; \quad б) 2f(x) = -\cos x;$$

$$в) f(x+2\pi) = -\frac{1}{2} \cos x; \quad г) f(-x) - f(x) = -\frac{1}{2} \cos x + \frac{1}{2} \cos x = 0.$$

13.7.

a)

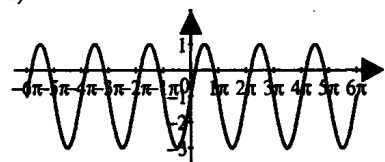

б)

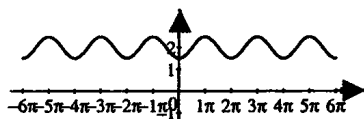

в)

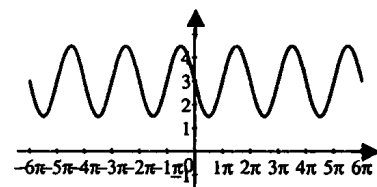

г)

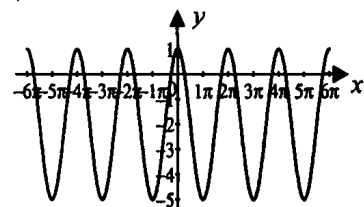

13.8.

a)

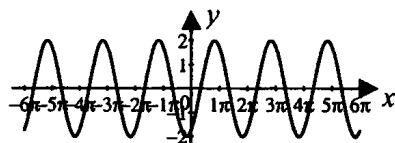

б)

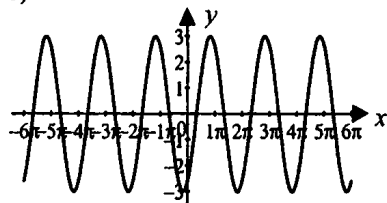

в)

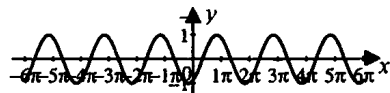

г)

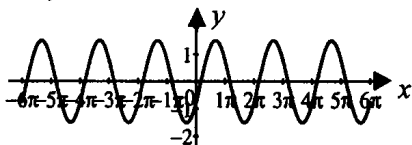

$$13.9. a) \begin{cases} x^2, & x < 0 \\ \frac{1}{2} \sin x, & 0 \leq x \leq \pi \end{cases}$$

$$б) \begin{cases} 1,5 \cos x, & x \in \left[-\frac{\pi}{2}; \frac{\pi}{2}\right] \\ x - \frac{\pi}{2}, & x > \frac{\pi}{2} \end{cases}$$

$$13.10. a) f(x) = \begin{cases} 3 \sin x, & x < \frac{\pi}{2} \\ 2 \cos x + 3, & x \geq \frac{\pi}{2} \end{cases}$$

1) $D(f) = R$;

2) $E(f) = [-3; 5]$;

3) при $x < \frac{\pi}{2}$ $T = 2\pi$,

при $x \geq \frac{\pi}{2}$ $T = 2\pi$;

4) ни четная, ни нечетная;

5) $f(x) = 0$ при $x = -\pi n, n \geq 0$

6) $f_{\min} = -3, f_{\max} = 5$

7) $f(x) < 0$ при $-\pi + 2\pi n < x < 2\pi n, n \leq 0$

$f(x) > 0$ при $2\pi n < x < \pi + 2\pi n,$

$n \leq -1$ и $x > 0$;

8) Убывает на промежутках

$$\left[\frac{\pi}{2} + 2\pi n, \frac{3\pi}{2} + 2\pi n \right], \left[\frac{\pi}{2}; \pi \right], [2\pi k; \pi + 2\pi k] \quad n \leq -1, k \geq 1.$$

Возрастает на промежутках

$$\left[-\frac{\pi}{2} + 2\pi n, \frac{\pi}{2} + 2\pi n \right] \quad n \leq 0, [-\pi + 2\pi k, 2\pi k] \quad k \geq 1.$$

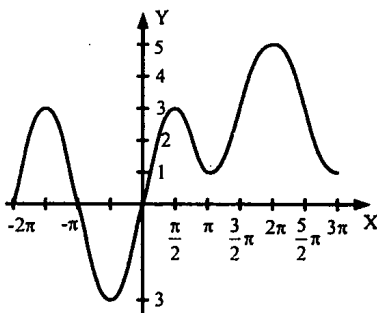

$$b) f(x) = \begin{cases} -2 \cos x, & x < 0 \\ \frac{1}{2} x^4, & x \geq 0 \end{cases}$$

1) $D(f) = R$;

2) $E(f) = [-2; +\infty]$;

3) при $x < 0$ $T = 2\pi$;

4) ни четная, ни нечетная;

5) $f(x) = 0$ при $x = -\frac{\pi}{2} - \pi n, n \geq 0,$

$x = 0$;

6) $f_{\min} = -2, f_{\max} = +\infty$;

7) $f(x) < 0$ при $x \in \left(-\frac{\pi}{2} - 2\pi n; \frac{\pi}{2} - 2\pi n \right) \cup \left(-\frac{\pi}{2}; 0 \right), n \geq 1,$

$f(x) > 0$ при $x \in \left(\frac{\pi}{2} - 2\pi n; \frac{3\pi}{2} - 2\pi n \right) \cup (0; +\infty), n \geq 1;$

8) $f(x)$ возрастает при $x \in [-2\pi n; -2\pi n + \pi], n \geq 1, x \geq 0,$

$f(x)$ убывает при $x \in [-2\pi n - \pi; -2\pi n], n \geq 0.$

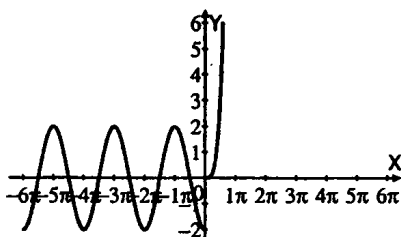

13.11.

a)

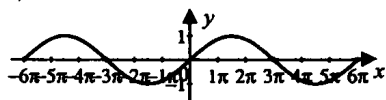

в)

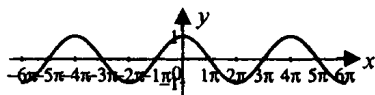

13.12.

a)

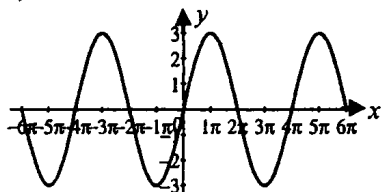

в)

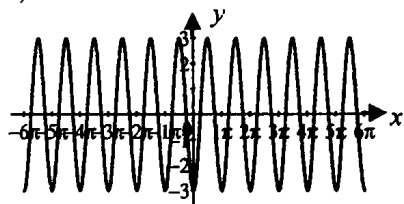

13.13.

a)

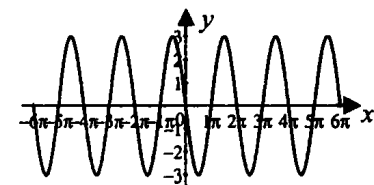

в)

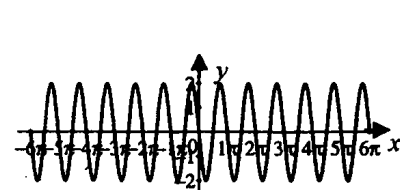

б)



г)



б)

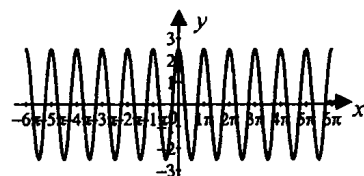

г)

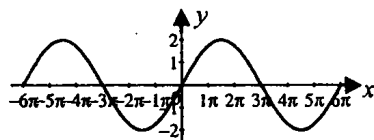

б)

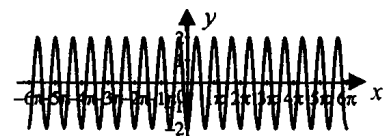

г)

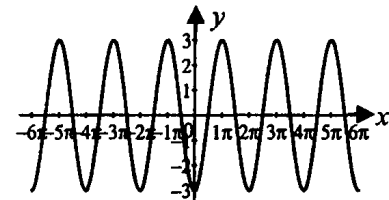

13.14. $y = \sin 2x$

а) $x \in [-\frac{\pi}{2}; 0]$, $y_{\max} = 0$, $y_{\min} = -1$; б) $x \in (-\frac{\pi}{4}; \frac{\pi}{2})$, $y_{\max} = 1$;

в) $x \in [-\frac{\pi}{4}; \frac{\pi}{4}]$, $y_{\min} = -1$, $y_{\max} = 1$; г) $x \in (0; \pi]$, $y_{\min} = -1$, $y_{\max} = 1$.

13.15. $y = \cos \frac{x}{3}$

а) $x \in [0; +\infty)$, $y_{\max} = 1$, $y_{\min} = -1$;

б) $x \in (-\infty; \pi)$, $y_{\max} = 1$, $y_{\min} = -1$;

в) $x \in [-\infty; \frac{\pi}{2}]$, $y_{\max} = 1$, $y_{\min} = -1$;

г) $x \in (\frac{\pi}{3}; +\infty)$, $y_{\max} = 1$, $y_{\min} = -1$.

13.16. $f(x) = \cos \frac{x}{3}$

а) $f(-x) = \cos \frac{x}{3}$; б) $3f(x) = 3 \cos \frac{x}{3}$;

в) $f(-3x) = \cos x$; г) $f(-x) - f(x) = 0$.

13.17. $f(x) = \sin 2x$

а) $f(-x) = -\sin 2x$; б) $2f(x) = 2\sin 2x$;

в) $f(-3x) = -\sin 6x$; г) $f(-x) + f(x) = 0$.

13.18. а)



в)

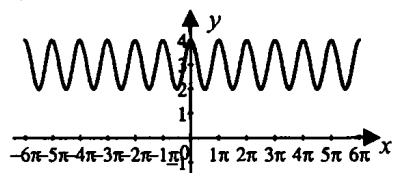

б)

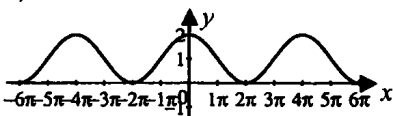

г)

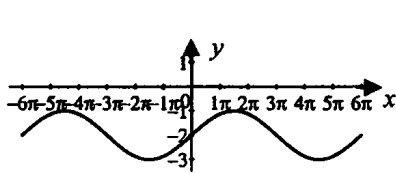

13.19. а) $f(x) = \begin{cases} \cos 2x, & x \leq \pi \\ -\frac{1}{2}, & x > \pi \end{cases}$

1) $D(f) = \mathbb{R}$; 2) $E(f) = [-1; 1]$;

3) при $x \leq \pi$ $T = \pi$; 4) ни четная, ни нечетная;

5) $f(x) = 0$ при $x = -\frac{\pi}{4} + \frac{\pi n}{2}$, $n \leq -2$;

$$6) f_{\min} = -1, f_{\max} = 1;$$

$$7) f(x) < 0 \text{ при } x \in \left(\frac{\pi}{4} - \pi n; \frac{3}{4}\pi - \pi n \right) \cup (\pi; +\infty), n \geq 0,$$

$$f(x) > 0 \text{ при } x \in \left(-\frac{\pi}{4} - \pi n; \frac{\pi}{4} - \pi n \right) \cup \left(\frac{3}{4}\pi; \pi \right], n \geq 0;$$

$$8) f(x) \text{ возрастает при } x \in \left[\frac{\pi}{2} - \pi n; \pi - \pi n \right], n \geq 0,$$

$$f(x) \text{ убывает при } x \in \left[-\pi n; \frac{\pi}{2} - \pi n \right], n \geq 0.$$

$$6) f(x) = \begin{cases} -\sin 3x, & x < 0 \\ \sqrt{x}, & x \geq 0 \end{cases}$$

$$1) D(f) = \mathbb{R};$$

$$2) E(f) = [-1; +\infty);$$

$$3) \text{ при } x \leq 0 T = \frac{2}{3}\pi;$$

4) ни четная, ни нечетная;

$$5) f(x) = 0 \text{ при } x = -\frac{\pi n}{3}, n \geq 0;$$

$$6) f_{\min} = -1, f_{\max} = +\infty;$$

$$7) f(x) < 0 \text{ при } x \in \left(-\frac{2}{3}\pi; \frac{\pi}{3} - \frac{2}{3}\pi n \right), n \geq 1, f(x) > 0 \text{ при}$$

$$x \in \left(-\frac{\pi}{3} - \frac{2}{3}\pi n; -\frac{2}{3}\pi n \right), n \geq 0, x \geq 0;$$

$$8) f(x) \text{ возрастает при } x \in \left[\frac{\pi}{6} - \frac{2}{3}\pi n; \frac{\pi}{2} - \frac{2}{3}\pi n \right], n \geq 1, x \in [0; +\infty),$$

$$f(x) \text{ убывает при } x \in \left[-\frac{\pi}{6} - \frac{3}{2}\pi n; \frac{\pi}{6} - \frac{3}{2}\pi n \right], n \geq 1, x \in \left[-\frac{\pi}{3}; 0 \right].$$

13.20.

$$a) y = \begin{cases} -x, & x < 0 \\ \sin 2x, & x \geq 0 \end{cases}$$

$$6) y = \begin{cases} \cos 3x, & x \in \left[-\frac{\pi}{6}; \frac{\pi}{3} \right] \\ -1, & x > \frac{\pi}{3} \end{cases}$$

$$в) y = \begin{cases} \sin 2x, & x \leq 0 \\ 2 \cos x, & x > 0 \end{cases}$$

$$г) y = \begin{cases} -2 \sin x, & x \in [-2\pi; 0] \\ \cos \frac{x}{2}, & x \in (0; 3\pi] \end{cases}$$

В ответах учебника для пункта в) ошибка.

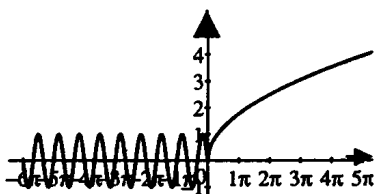

**§ 14. Функции $y = \operatorname{tg} x$, $y = \operatorname{ctg} x$,
их свойства и графики**

14.1. $y = \operatorname{tg} x$

а) $\operatorname{tg} \frac{\pi}{4} = 1$; б) $\operatorname{tg} \frac{2\pi}{3} = -\sqrt{3}$;

в) $\operatorname{tg} \frac{3\pi}{4} = -1$; г) $\operatorname{tg} \pi = 0$.

14.2. $y = \operatorname{tg} x$.

а) $x \in (\frac{\pi}{2}; \frac{3\pi}{2})$, $y_{\min} = -\infty$, $y_{\max} = +\infty$;

б) $x \in (\frac{3\pi}{4}; \pi]$, y_{\min} не существует, $y_{\max} = 0$;

в) $x \in [-\frac{\pi}{4}; \frac{\pi}{6}]$, $y_{\min} = -1$, $y_{\max} = \frac{\sqrt{3}}{3}$

г) $x \in [\pi; \frac{3\pi}{2})$, $y_{\min} = 0$, y_{\max} не существует.

14.3. а) $x = -\frac{\pi}{3} + \pi n$;

б) $x = \frac{\pi}{4} + \pi n$;

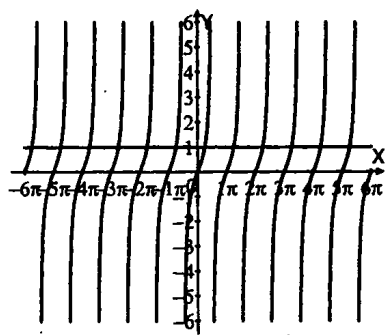
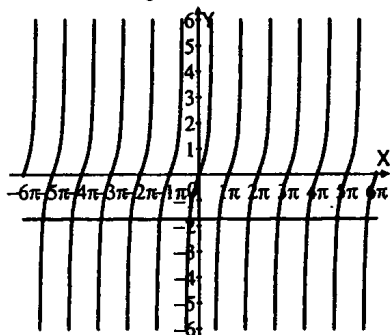

в) $x = -\frac{\pi}{4} + \pi n$;

г) $x = \pi n$.

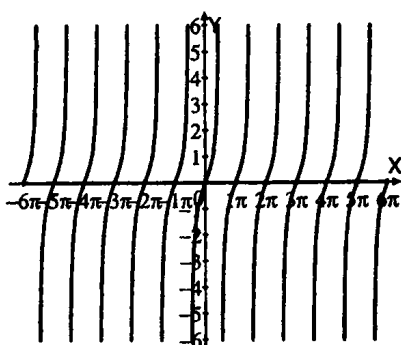
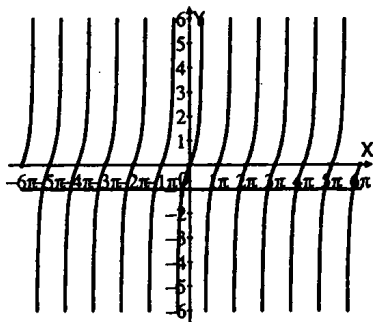

14.4. а) $\operatorname{ctg} \frac{\pi}{4} = 1$;

б) $\operatorname{ctg} \frac{\pi}{3} = \frac{\sqrt{3}}{3}$;

в) $\operatorname{ctg} 2\pi$ не существует;

г) $\operatorname{ctg} \frac{\pi}{2} = 0$.

14.5. $y = \operatorname{ctg} x$.

а) $x \in [\frac{\pi}{4}; \frac{\pi}{2}]$, $y_{\max} = 1$, $y_{\min} = 0$;

б) $x \in [\frac{\pi}{2}; \pi)$, $y_{\max} = 0$, y_{\min} не существует;

в) $x \in (-\pi; 0)$, y_{\max} , y_{\min} не существуют;

г) $x \in [\frac{\pi}{6}; \frac{3\pi}{4}]$, $y_{\max} = \sqrt{3}$, $y_{\min} = -1$.

14.6. а) $x = \frac{\pi}{4} + \pi k$;

б) $x = \frac{\pi}{3} + \pi k$;

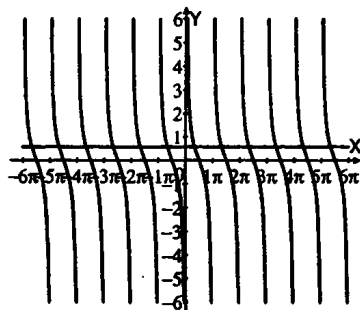
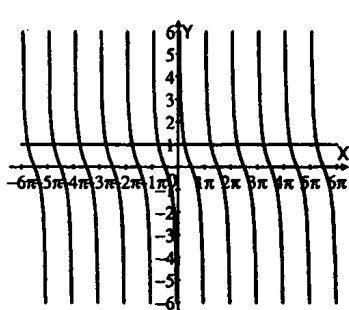

в) $x = -\frac{\pi}{3} + \pi k$;

г) $x = \frac{\pi}{2} + \pi k$.

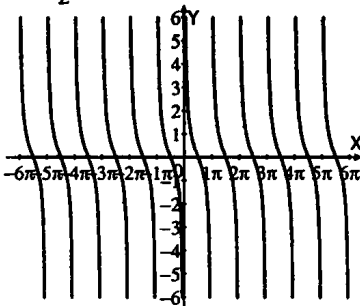
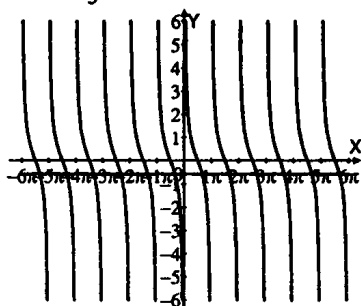

14.7. а) $f(x) = \operatorname{tg} x - \cos x$, $f(-x) = -\operatorname{tg} x - \cos x$, ни четная, ни нечетная;

б) $f(x) = \operatorname{tg} x + x$, $f(-x) = -\operatorname{tg} x - x = -f(x)$, нечетная;

в) $f(x) = \operatorname{ctg}^2 x - x^4$, $f(-x) = \operatorname{ctg}^2 x - x^4$, четная;

г) $f(x) = x^3 - \operatorname{ctg} x$, $f(-x) = -x^3 + \operatorname{ctg} x = -f(x)$, нечетная.

14.8. $\operatorname{tg}(9\pi - x) = -\frac{3}{4}$; $\operatorname{tg}(9\pi - x) = -\operatorname{tg} x$; $\operatorname{tg} x = \frac{3}{4}$, $\operatorname{ctg} x = \frac{4}{3}$.

14.9. $\operatorname{ctg}(7\pi - x) = \frac{5}{7}$; $\operatorname{ctg} x = -\frac{5}{7}$, $\operatorname{tg} x = -\frac{7}{5}$

14.10. а) $\operatorname{tg} 200^\circ - \operatorname{tg} 201^\circ < 0$; б) $\operatorname{tg} 1 - \operatorname{tg} 1,01 < 0$;

в) $\operatorname{tg} 2,2 - \operatorname{tg} 2,1 > 0$; г) $\operatorname{tg} \frac{3\pi}{5} - \operatorname{tg} \frac{6\pi}{5} < 0$.

14.11. $f(x) = \operatorname{tg} x$, $f(2x + 2\pi) + f(7\pi - 2x) = \operatorname{tg}(2x + 2\pi) + \operatorname{tg}(7\pi - 2x) = \operatorname{tg} 2x - \operatorname{tg} 2x = 0$.

14.12. $f(x) = x^2 + 1$, $f(\operatorname{tg} x) = \operatorname{tg}^2 x + 1 = \frac{1}{\cos^2 x}$.

14.13. а)

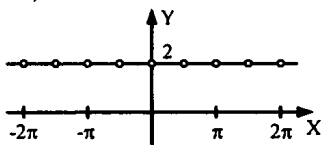

б)

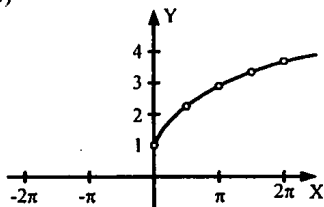

14.14.

а)

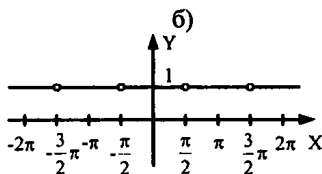

б)

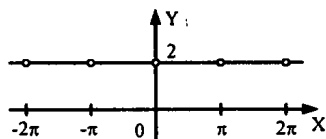

14.15. а) см. график 276 (а)

б)

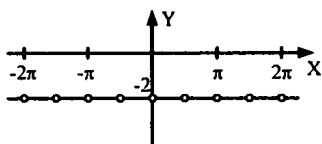

Глава 3. Тригонометрические уравнения

§ 15. Арккосинус. Решение уравнения $\cos t = a$.

15.1. а) $\arccos 0 = \frac{\pi}{2}$;

б) $\arccos 1 = 0$;

в) $\arccos \frac{\sqrt{3}}{2} = \frac{\pi}{6}$;

г) $\arccos \frac{1}{2} = \frac{\pi}{3}$.

15.2. а) $\arccos \left(-\frac{\sqrt{2}}{2}\right) = \frac{3\pi}{4}$;

б) $\arccos \left(-\frac{\sqrt{3}}{2}\right) = \frac{5\pi}{6}$;

в) $\arccos(-1) = \pi$;

г) $\arccos \left(-\frac{1}{2}\right) = \frac{2\pi}{3}$.

15.3. а) $\arccos(-1) + \arccos 0 = \pi + \frac{\pi}{2} = \frac{3\pi}{2}$;

б) $\arccos \frac{1}{2} - \arccos \frac{\sqrt{3}}{2} = \frac{\pi}{3} - \frac{\pi}{6} = \frac{\pi}{6}$;

в) $\arccos \left(-\frac{\sqrt{2}}{2}\right) + \arccos \frac{\sqrt{2}}{2} = \frac{3\pi}{4} + \frac{\pi}{4} = \pi$;

г) $\arccos \left(-\frac{1}{2}\right) - \arccos \frac{1}{2} = \frac{2\pi}{3} - \frac{\pi}{3} = \frac{\pi}{3}$.

15.4. а) $\sin \left(\arccos \left(-\frac{1}{2}, \frac{1}{2}\right)\right) = \sin \frac{2\pi}{3} = \frac{\sqrt{3}}{2}$;

б) $\operatorname{tg} \left(\arccos \frac{\sqrt{3}}{2}\right) = \operatorname{tg} \frac{\pi}{6} = \frac{\sqrt{3}}{3}$;

в) $\operatorname{ctg} (\arccos 0) = \operatorname{ctg} \frac{\pi}{2} = 0$;

г) $\sin \left(\arccos \frac{\sqrt{2}}{2}\right) = \sin \frac{\pi}{4} = \frac{\sqrt{2}}{2}$.

15.5. а) $\cos \left(2 \arccos \frac{1}{2} - 3 \arccos 0 - \arccos \left(-\frac{1}{2}\right)\right) = \cos \left(\frac{2\pi}{3} - \frac{3\pi}{2} - \frac{2\pi}{3}\right) =$

$= \cos \frac{3\pi}{2} = 0$;

б) $\cos x = \frac{\sqrt{2}}{2}$, $x = \pm \frac{\pi}{4} + 2\pi n$.

в) $\cos t = 1$, $t = 2\pi n$, $n \in \mathbb{Z}$

г) $\cos t = \frac{\sqrt{3}}{2}$, $t = \pm \frac{\pi}{6} + 2\pi n$, $n \in \mathbb{Z}$

15.6. а) $\cos t = -1, t = \pi + 2\pi n, n \in \mathbb{Z}$

б) $\cos x = -\frac{\sqrt{3}}{2}, x = \pm \frac{5\pi}{6} + 2\pi n;$

в) $\cos t = -\frac{1}{2} \Rightarrow t = \pm \frac{2\pi}{3} + 2\pi n, n \in \mathbb{Z}$

г) $\cos x = -\frac{\sqrt{2}}{2}, t = \pm \frac{3\pi}{4} + 2\pi n;$

15.7. а) $\cos x = \frac{1}{3}, x = \pm \arccos \frac{1}{3} + 2\pi n;$

б) $\cos x = -1.1$, решений нет;

в) $\cos t = -\frac{3}{7} \Rightarrow t = \pm \arccos\left(-\frac{3}{7}\right) + 2\pi n, n \in \mathbb{Z}$

г) $\cos t = 2.04 \Rightarrow$ решений нет.

15.8. а) $\cos\left(2 \arccos \frac{1}{2} - 3 \arccos 0 - \arccos\left(-\frac{1}{2}\right)\right) = \cos\left(\frac{2\pi}{3} - \frac{3\pi}{2} - \frac{2\pi}{3}\right) =$
 $= \cos \frac{3\pi}{2} = 0;$

б) $\frac{1}{3} \left(\arccos \frac{1}{3} + \arccos\left(-\frac{1}{3}\right)\right) = \frac{1}{3} \pi = \frac{\pi}{3}.$

15.9. а) $[-1; 1];$ б) $\left[-\frac{1}{2}; \frac{1}{2}\right];$ в) $[0; 2];$ г) $[1; 2].$

15.10. а) $\arccos \sqrt{5}$, - нет; б) $\arccos \sqrt{\frac{2}{3}}$, - да;

в) $\arccos \frac{\pi}{5}$, - да; г) $\arccos(-\sqrt{3})$, - нет.

15.11. $\operatorname{tg}(\arccos 0, 1 + \arccos(-0, 1) + x) = \operatorname{tg} x, \operatorname{tg}(\pi + x) = \operatorname{tg} x.$

15.12. а) $\frac{8 \cos x - 3}{3 \cos x + 2} = 1, \frac{8 \cos x - 3 - 3 \cos x - 2}{3 \cos x + 2} = 0,$

$$\begin{cases} 5 \cos x - 5 = 0 \\ \cos x \neq -\frac{2}{3} \end{cases}, \cos x = 1, x = 2\pi n;$$

б) $\frac{3 \cos x + 1}{2} + \frac{5 \cos x - 1}{3} = 1 \frac{3}{4},$

$$9 \cos x + 3 + 10 \cos x - 2 = \frac{7}{4} \cdot 6 = \frac{21}{2},$$

$$19 \cos x = \frac{19}{2}, \cos x = \frac{1}{2}, x = \pm \frac{\pi}{3} + 2\pi n.$$

$$15.13. \text{ а) } 6 \cos^2 x + 5 \cos x + 1 = 0,$$

$$\cos x = \frac{-5+1}{12} = -\frac{1}{3},$$

$$x = \pm \arccos\left(-\frac{1}{3}\right) + 2\pi n.$$

$$\cos x = \frac{-5-1}{12} = -\frac{1}{2}, \quad x = \pm \frac{2}{3}\pi + 2\pi n.$$

$$\text{б) } 3 + 9\cos x = 5\sin x, \quad 5\cos^2 x + 9\cos x - 2 = 0;$$

$$\cos x = \frac{-9 \pm 11}{10} \quad \cos x = -2 \text{ не существует.}$$

$$\cos x = \frac{1}{5} \quad x = \pm \arccos \frac{1}{5} + 2\pi n.$$

$$15.14. \text{ а) } \cos x = \frac{\sqrt{3}}{2}, \quad x \in [0, 2\pi]$$

$$x = \pm \frac{\pi}{6} + 2\pi n, \quad n \in \mathbb{Z}$$

$$\text{Ответ: } \frac{\pi}{6}, \frac{11}{6}\pi;$$

$$\text{б) } \cos x = -\frac{1}{2}, \quad x \in [2\pi, 4\pi]$$

$$x = \pm \frac{2}{3}\pi + 2\pi n, \quad n \in \mathbb{Z}$$

$$\text{Ответ: } \frac{8}{3}\pi, \frac{10}{3}\pi;$$

$$\text{в) } \cos x = \frac{\sqrt{2}}{2}, \quad x \in [-\pi, 3\pi]$$

$$x = \pm \frac{\pi}{4} + 2\pi n, \quad n \in \mathbb{Z}$$

$$\text{Ответ: } -\frac{\pi}{4}, \frac{\pi}{4}, \frac{7\pi}{4}, \frac{9\pi}{4};$$

$$\text{г) } \cos x = -1, \quad x \in \left[-\frac{3\pi}{2}, 2\pi\right]$$

$$x = \pi + 2\pi n, \quad n \in \mathbb{Z}$$

$$\text{Ответ: } -\pi, \pi.$$

$$15.15. \text{ а) } \cos x = \frac{1}{2}, \quad x \in (1, 6) \quad x = \pm \frac{\pi}{3} + 2\pi n.$$

$$\text{Ответ: } \frac{\pi}{3}, \frac{5\pi}{3};$$

$$\text{б) } \cos x = -\frac{1}{2}, \quad x \in (2, 10) \quad x = \pm \frac{2\pi}{3} + 2\pi n.$$

$$\text{Ответ: } \frac{2\pi}{3}, \frac{4\pi}{3}, \frac{8\pi}{3};$$

$$\text{в) } \cos x = \frac{\sqrt{2}}{2}, \quad x \in \left(-\frac{\pi}{4}, 12\right), \quad x = \pm \frac{\pi}{4} + 2\pi n.$$

$$\text{Ответ: } \frac{\pi}{4}, \frac{7\pi}{4}, \frac{9\pi}{4}, \frac{15\pi}{4};$$

$$\text{г) } \cos x = -\frac{\sqrt{2}}{2}, \quad x \in \left(-4, \frac{5\pi}{4}\right), \quad x = \pm \frac{3\pi}{4} + 2\pi n.$$

$$\text{Ответ: } -\frac{3\pi}{4}, \frac{3\pi}{4}, \frac{5\pi}{4}.$$

15.16.

а)

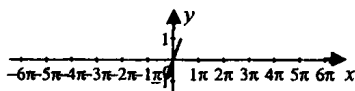
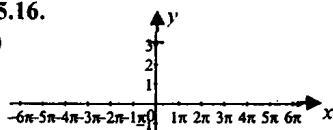

$$15.17. \text{ а) } \cos t > \frac{1}{2}, \quad t \in \left(-\frac{\pi}{3} + 2\pi k; \frac{\pi}{3} + 2\pi k\right);$$

$$\text{б) } \cos t \leq -\frac{\sqrt{2}}{2}, \quad t \in \left[\frac{3\pi}{4} + 2\pi k; \frac{5\pi}{4} + 2\pi k\right];$$

$$\text{в) } \cos t \geq -\frac{\sqrt{2}}{2}, \quad t \in \left[-\frac{3\pi}{4} + 2\pi k; \frac{3\pi}{4} + 2\pi k\right];$$

$$\text{г) } \cos t < \frac{1}{2}, \quad t \in \left(\frac{\pi}{3} + 2\pi k; \frac{5\pi}{3} + 2\pi k\right).$$

$$15.18. \text{ а) } \cos t < \frac{2}{3}, \quad t \in \left(\arccos \frac{2}{3} + 2\pi k; 2\pi - \arccos \frac{2}{3} + 2\pi k\right);$$

$$\text{б) } \cos t > -\frac{1}{7}, \quad t \in \left(-\arccos\left(-\frac{1}{7}\right) + 2\pi k; \arccos\left(-\frac{1}{7}\right) + 2\pi k\right);$$

$$\text{в) } \cos t > \frac{2}{3}, \quad t \in \left(-\arccos \frac{2}{3} + 2\pi k; \arccos \frac{2}{3} + 2\pi k\right);$$

$$\text{г) } \cos t < -\frac{1}{7}, \quad t \in \left(\arccos\left(-\frac{1}{7}\right) + 2\pi k; 2\pi - \arccos\left(-\frac{1}{7}\right) + 2\pi k\right).$$

$$15.19. \text{ а) } 3 \cos^2 t - 4 \cos t \geq 4, \quad 3 \cos^2 t - 4 \cos t - 4 = 0.$$

Найдем корни квадратного уравнения:

$$\cos t = \frac{4 \pm \sqrt{16 + 4 \cdot 3 \cdot 4}}{6} = \frac{4 \pm 8}{6},$$

$$\cos t = -\frac{2}{3}, \quad \cos t = 2 \text{ не подходит,}$$

$$\cos t \leq -\frac{2}{3}, \quad t \in \left[\arccos\left(-\frac{2}{3}\right) + 2\pi k, 2\pi - \arccos\left(-\frac{2}{3}\right) + 2\pi k\right];$$

$$\text{б) } 6 \cos^2 t + 1 > 5 \cos t.$$

Найдем корни квадратного уравнения:

$$6 \cos^2 t - 5 \cos t + 1 = 0,$$

$$\cos t = \frac{5+1}{12} = \frac{1}{2}, \quad \cos t = \frac{1}{3},$$

$$t \in \left(-\frac{\pi}{3} + 2\pi k; \frac{\pi}{3} + 2\pi k\right) \cup \left(\arccos \frac{1}{3} + 2\pi k; 2\pi - \arccos \frac{1}{3} + 2\pi k\right);$$

$$\text{в) } 3 \cos^2 t - 4 \cos t < 4,$$

$$3 \cos^2 t - 4 \cos t - 4 < 0.$$

Найдем корни квадратного уравнения:

$$3 \cos^2 t - 4 \cos t - 4 = 0.$$

$$\cos t = \frac{4 \pm \sqrt{16 + 4 \cdot 3 \cdot 4}}{6} = \frac{2 \pm 4}{3},$$

$$\cos t = 2 - \text{ не подходит,}$$

$$\cos t = -\frac{2}{3} \rightarrow \cos t > -\frac{2}{3},$$

$$t \in \left(-\arccos\left(-\frac{2}{3}\right) + 2\pi k; \arccos\left(-\frac{2}{3}\right) + 2\pi k\right);$$

$$r) 6 \cos^2 t + 1 \leq 5 \cos t, \quad 6 \cos^2 t - 5 \cos t + 1 \leq 0.$$

Найдем корни квадратного уравнения:

$$6 \cos^2 t - 5 \cos t + 1 = 0,$$

$$\cos t = \frac{5 \pm \sqrt{25 - 4 \cdot 6 \cdot 1}}{12} = \frac{5 \pm 1}{12},$$

$$\cos t = \frac{1}{2}, \quad \cos t = \frac{1}{3},$$

$$t \in \left[-\arccos\frac{1}{3} + 2\pi k; -\frac{\pi}{3} + 2\pi k\right] \cup \left[\frac{\pi}{3} + 2\pi k; \arccos\frac{1}{3} + 2\pi k\right].$$

$$15.20. \text{ a) } 4 \cos^2 t < 1, \quad \cos^2 t < \frac{1}{4},$$

$$\cos t \in \left(-\frac{1}{2}; \frac{1}{2}\right), \quad t \in \left(\frac{\pi}{3} + \pi k; \frac{2}{3}\pi + \pi k\right);$$

$$\text{б) } 3 \cos^2 t < \cos t, \quad \cos t (3 \cos t - 1) < 0, \quad \cos t \in \left(0; \frac{1}{3}\right),$$

$$t \in \left(-\frac{\pi}{2} + 2\pi n; -\arccos\frac{1}{3} + 2\pi n\right) \cup \left(\arccos\frac{1}{3} + 2\pi n; \frac{\pi}{2} + 2\pi n\right);$$

$$\text{в) } 9 \cos^2 t > 1, \quad \cos^2 t - \frac{1}{9} > 0$$

$$\begin{cases} \cos t > \frac{1}{3} \\ \cos t < -\frac{1}{3} \end{cases} \quad t \in \left(-\arccos\frac{1}{3} + 2\pi n, \arccos\frac{1}{3} + 2\pi n\right) \cup \left(\arccos\left(-\frac{1}{3}\right) + 2\pi n, 2\pi - \arccos\left(-\frac{1}{3}\right) + 2\pi n\right);$$

$$r) 3 \cos^2 t - \cos t > 0$$

$$\cos t \left(\cos t - \frac{1}{3}\right) > 0$$

$$\begin{cases} \cos t < 0 \\ \cos t > \frac{1}{3} \end{cases} \quad t \in \left(-\arccos\frac{1}{3} + 2\pi n, \arccos\frac{1}{3} + 2\pi n\right) \cup \left(\frac{\pi}{2} + 2\pi n, \frac{3\pi}{2} + 2\pi n\right).$$

$$15.21. \text{ a) } \sin\left(\arccos\frac{3}{5}\right) = \sqrt{1 - \cos^2\left(\arccos\frac{3}{5}\right)} = \frac{4}{5}$$

$$\text{б) } \sin(\arccos(-0,8)) = \sqrt{1 - \cos^2(\arccos(-0,8))} = 0,6$$

$$15.22. \text{ a) } \operatorname{tg}\left(\arccos\left(-\frac{5}{13}\right)\right) = \frac{\sqrt{1 - \cos^2\left(\arccos\left(-\frac{5}{13}\right)\right)}}{\cos\left(\arccos\left(-\frac{5}{13}\right)\right)} = -\frac{12}{5}$$

$$\text{б) } \operatorname{ctg}\left(\arccos\frac{4}{5}\right) = \frac{\cos\left(\arccos\left(\frac{4}{5}\right)\right)}{\sqrt{1 - \cos^2\left(\arccos\left(\frac{4}{5}\right)\right)}} = \frac{4}{3}$$

§ 16. Арксинус.

Решение уравнения $\sin t = a$

$$16.1. \text{ a) } \arcsin \frac{\sqrt{3}}{2} = \frac{\pi}{3};$$

$$\text{б) } \arcsin 1 = \frac{\pi}{2};$$

$$\text{в) } \arcsin \frac{\sqrt{2}}{2} = \frac{\pi}{4};$$

$$\text{г) } \arcsin 0 = 0.$$

$$16.2. \text{ a) } \arcsin\left(-\frac{\sqrt{3}}{2}\right) = -\frac{\pi}{3};$$

$$\text{б) } \arcsin\left(-\frac{1}{2}\right) = -\frac{\pi}{6};$$

$$\text{в) } \arcsin(-1) = -\frac{\pi}{2};$$

$$\text{г) } \arcsin\left(-\frac{\sqrt{2}}{2}\right) = -\frac{\pi}{4}.$$

$$16.3. \text{ a) } \arcsin 0 + \arccos 0 = \frac{\pi}{2};$$

$$\text{б) } \arcsin \frac{\sqrt{2}}{2} + \arccos \frac{\sqrt{3}}{2} = \frac{\pi}{2};$$

$$\text{в) } \arcsin\left(-\frac{\sqrt{2}}{2}\right) + \arccos \frac{1}{2} = \frac{\pi}{12}; \quad \text{г) } \arcsin(-1) + \arccos \frac{\sqrt{3}}{2} = -\frac{\pi}{3}.$$

$$16.4. \text{ a) } \arccos\left(-\frac{1}{2}\right) + \arcsin\left(-\frac{1}{2}\right) = \frac{\pi}{2};$$

$$\text{б) } \arccos\left(-\frac{\sqrt{2}}{2}\right) - \arcsin(-1) = \frac{5\pi}{4};$$

$$\text{в) } \arccos\left(-\frac{\sqrt{3}}{2}\right) + \arcsin\left(-\frac{\sqrt{3}}{2}\right) = \frac{\pi}{2};$$

$$\text{г) } \arccos \frac{\sqrt{2}}{2} - \arcsin\left(-\frac{\sqrt{3}}{2}\right) = \frac{7\pi}{12}.$$

$$16.5. \text{ a) } \sin x = \frac{\sqrt{3}}{2}, \quad x = (-1)^k \frac{\pi}{3} + \pi k;$$

$$\text{б) } \sin x = \frac{\sqrt{2}}{2}, \quad x = (-1)^k \frac{\pi}{4} + \pi k;$$

$$в) \sin x = 1, x = \frac{\pi}{2} + 2\pi n;$$

$$г) \sin x = \frac{1}{2}, x = (-1)^k \frac{\pi}{6} + \pi k.$$

$$16.6. а) \sin x = -1, x = -\frac{\pi}{2} + 2\pi n;$$

$$б) \sin x = -\frac{\sqrt{2}}{2}, x = (-1)^{k+1} \frac{\pi}{4} + \pi k;$$

$$в) \sin x = -\frac{1}{2}, x = (-1)^{k+1} \frac{\pi}{6} + \pi k;$$

$$г) \sin x = -\frac{\sqrt{3}}{2}, x = (-1)^{k+1} \frac{\pi}{3} + \pi k.$$

16.7.

$$а) \sin x = \frac{1}{4}, x = (-1)^k \arcsin \frac{1}{4} + \pi k; б) \sin x = 1.02, \text{ решений нет};$$

$$в) \sin x = -\frac{1}{7}, x = (-1)^k \arcsin \left(-\frac{1}{7}\right) + \pi k; г) \sin x = \frac{\pi}{3}, \text{ решений нет}.$$

$$16.8. а) \sin (\arccos x + \arccos (-x)) = 0, \sin \pi = 0;$$

$$б) \cos (\arcsin x + \arcsin (-x)) = 1, \cos 0 = 1.$$

$$16.9. а) \sin x = \frac{1}{2}, x \in [0, 2\pi]$$

$$б) \cos x = -\frac{1}{2}, x \in [-\pi, \pi]$$

$$x = (-1)^n \frac{\pi}{6} + \pi n.$$

$$x = \pm \frac{2\pi}{3} + 2\pi n.$$

$$\text{Ответ: } \frac{\pi}{6}, \frac{5\pi}{6}.$$

$$\text{Ответ: } \pm \frac{2\pi}{3}$$

$$в) \sin x = -\frac{\sqrt{2}}{2}, x \in [-\pi, 2\pi]$$

$$г) \cos x = \frac{\sqrt{3}}{2}, x \in [-2\pi, \pi]$$

$$x = (-1)^{n+1} \frac{\pi}{4} + \pi n.$$

$$x = \pm \frac{\pi}{6} + 2\pi n.$$

$$\text{Ответ: } -\frac{\pi}{4}, \frac{5\pi}{4}, \frac{7\pi}{4};$$

$$\text{Ответ: } -\frac{11}{6}\pi, -\frac{\pi}{6}, \frac{\pi}{6}.$$

$$16.10. а) \sin x = \frac{1}{2}, x \in \left(\frac{1}{2}, \frac{11\pi}{4}\right)$$

$$б) \sin x = -\frac{1}{2}, x \in \left(-\frac{5\pi}{6}, 6\right)$$

$$x = (-1)^n \frac{\pi}{6} + \pi n.$$

$$x = (-1)^{n+1} \frac{\pi}{6} + \pi n.$$

$$\text{Ответ: } \frac{\pi}{6}, \frac{5\pi}{6}, \frac{13\pi}{6}.$$

$$\text{Ответ: } -\frac{\pi}{6}, \frac{7\pi}{6}, \frac{11\pi}{6}.$$

$$в) \sin x = \frac{\sqrt{2}}{2}, x \in (-4, 3)$$

$$x = (-1)^n \frac{\pi}{4} + \pi n.$$

$$\text{Ответ: } -\frac{5\pi}{4}, \frac{\pi}{4}, \frac{3\pi}{4}.$$

$$г) \sin x = \frac{\sqrt{2}}{2}, x \in (-3, 6)$$

$$\text{Ответ: } \frac{\pi}{4}, \frac{3\pi}{4}.$$

$$16.11. а) \arcsin x, x \in [-1; 1];$$

$$б) \arcsin(5 - 2x), x \in [2; 3];$$

$$в) \arcsin \frac{x}{2}, x \in [-2; 2];$$

$$г) \arcsin(x^2 - 3), x \in [-2; -\sqrt{2}] \cup [\sqrt{2}; 2].$$

$$16.12. а) \arcsin(-\frac{2}{3}). \text{ Да; } б) \arcsin 1.5. \text{ Нет;}$$

$$в) \arcsin(3 - \sqrt{20}). \text{ Нет; } г) \arcsin(4 - \sqrt{20}). \text{ Да.}$$

$$16.13. а) (2 \cos x + 1)(2 \sin x - \sqrt{3}) = 0,$$

$$\begin{cases} \cos x = -\frac{1}{2}, & x = \pm \frac{2\pi}{3} + 2\pi k, \\ \sin x = \frac{\sqrt{3}}{2}, & x = (-1)^n \frac{\pi}{3} + \pi n; \end{cases} \pm \frac{2\pi}{3} + 2\pi k, \frac{\pi}{3} + 2\pi k;$$

$$б) 2 \cos x - 3 \sin x \cos x = 0, \cos x(2 - 3 \sin x) = 0,$$

$$\begin{cases} \cos x = 0 \\ \sin x = \frac{2}{3} \end{cases}, x = \frac{\pi}{2} + \pi n, x = (-1)^k \arcsin \frac{2}{3} + \pi k;$$

$$в) 4 \sin^2 x - 3 \sin x = 0, \sin x(4 \sin x - 3) = 0, \sin x = 0, \sin x = \frac{3}{4},$$

$$x = \pi n, x = (-1)^k \arcsin \frac{3}{4} + \pi k;$$

$$г) 2 \sin^2 x - 1 = 0, \sin x = \pm \frac{\sqrt{2}}{2}, x = \frac{\pi}{4} + \frac{\pi n}{2}.$$

$$16.14. а) 6 \sin^2 x + \sin x - 2 = 0, \sin x = \frac{-1+7}{12} = \frac{1}{2}, (-1)^n \frac{\pi}{6} + \pi n,$$

$$\sin x = -\frac{2}{3}, (-1)^{k+1} \arcsin \frac{2}{3} + \pi k;$$

$$б) 3 \cos^2 x = 7(\sin x + 1), 3 - 3 \sin^2 x = 7 \sin x + 7, 3 \sin^2 x + 7 \sin x + 4 = 0,$$

$$\sin x = \frac{-7 + \sqrt{49 - 4 \cdot 3 \cdot 4}}{6} = \frac{-7 \pm 1}{6}, \sin x = \frac{-8}{6} \text{ — не существует,}$$

$$\sin x = -1, x = -\frac{\pi}{2} + 2\pi n.$$

$$16.15. \text{ a) } \sin t > \frac{\sqrt{3}}{2}, \quad t \in \left(\frac{\pi}{3} + 2\pi k; \frac{2\pi}{3} + 2\pi k \right);$$

$$\text{б) } \sin t > -\frac{1}{2}, \quad t \in \left(-\frac{\pi}{6} + 2\pi k; \frac{7\pi}{6} + 2\pi k \right);$$

$$\text{в) } \sin t < \frac{\sqrt{3}}{2}, \quad t \in \left(-\frac{4\pi}{3} + 2\pi k; \frac{\pi}{3} + 2\pi k \right);$$

$$\text{г) } \sin t \leq -\frac{1}{2}, \quad t \in \left[\frac{7\pi}{6} + 2\pi k; \frac{11\pi}{6} + 2\pi k \right].$$

$$16.16. \text{ a) } \sin t < \frac{1}{3}, \quad t \in \left(-\pi - \arcsin \frac{1}{3} + 2\pi k; \arcsin \frac{1}{3} + 2\pi k \right);$$

$$\text{б) } \sin t \geq -\frac{3}{5}, \quad t \in \left[-\arcsin \frac{3}{5} + 2\pi k; \pi + \arcsin \frac{3}{5} + 2\pi k \right];$$

$$\text{в) } \sin t \geq \frac{1}{3}, \quad t \in \left[\arcsin \frac{1}{3} + 2\pi k; \pi - \arcsin \frac{1}{3} + 2\pi k \right];$$

$$\text{г) } \sin t < -\frac{3}{5}, \quad t \in \left(\pi + \arcsin \frac{3}{5} + 2\pi k; 2\pi - \arcsin \frac{3}{5} + 2\pi k \right).$$

16.17.

$$\text{a) } 5\sin^2 t > 11\sin t + 12, \quad 5\sin^2 t - 11\sin t - 12 = 0,$$

$$\sin t = \frac{11+19}{10}, \quad \text{не существует.} \quad \sin t = -\frac{8}{10},$$

$$t \in \left(\pi + \arcsin \frac{4}{5} + 2\pi k; 2\pi - \arcsin \frac{4}{5} + 2\pi k \right)$$

$$\text{б) } 5\sin^2 t \leq 11\sin t + 12, \quad 5\sin^2 t - 11\sin t - 12 = 0,$$

$$\sin t = -\frac{4}{5}, \quad t \in \left[-\arcsin \frac{4}{5} + 2\pi k; \pi + \arcsin \frac{4}{5} + 2\pi k \right].$$

$$16.18. \text{ a) } 6\cos^2 t + \sin t > 4,$$

$$6 - 6\sin^2 t + \sin t - 4 > 0,$$

$$6\sin^2 t - \sin t - 2 < 0,$$

$$\sin t = \frac{1+7}{12} = \frac{3}{4}, \quad \sin t = -\frac{1}{2},$$

$$t \in \left(-\frac{\pi}{6} + 2\pi k; \arcsin \frac{2}{3} + 2\pi k \right) \cup \left(\pi - \arcsin \frac{2}{3} + 2\pi k; \frac{7\pi}{6} + 2\pi k \right);$$

$$\text{б) } 6\cos^2 t + \sin t \leq 4,$$

$$6\sin^2 t - \sin t - 2 = 0,$$

$$\sin t = \frac{3}{4}, \quad \sin t = -\frac{1}{2},$$

$$t \in \left[\arcsin \frac{2}{3} + 2\pi k; \pi - \arcsin \frac{2}{3} + 2\pi k \right], \quad t \in \left[\frac{7\pi}{6} + 2\pi k; \frac{11\pi}{6} + 2\pi k \right].$$

$$16.19. \text{ a) } \cos\left(\arcsin\left(-\frac{5}{13}\right)\right) = \sqrt{1 - \sin^2\left(\arcsin\left(-\frac{5}{13}\right)\right)} = \frac{12}{13}$$

$$\text{б) } \operatorname{tg}(\arcsin(0,6)) = \frac{\sin(\arcsin(0,6))}{\sqrt{1 - \sin^2(\arcsin(0,6))}} = \frac{3}{4}$$

$$\text{в) } \cos\left(\arcsin\frac{8}{17}\right) = \sqrt{1 - \sin^2\left(\arcsin\left(\frac{8}{17}\right)\right)} = \frac{15}{17}$$

$$\text{г) } \operatorname{ctg}(\arcsin(-0,8)) = \frac{\sqrt{1 - \sin^2(\arcsin(-0,8))}}{\sin(\arcsin(-0,8))} = -\frac{3}{4}$$

**§ 17. Арктангенс и арккотангенс.
Решение уравнений $\operatorname{tg}x = a$, $\operatorname{ctg}x = a$.**

$$17.1. \text{ a) } \operatorname{arctg} \frac{\sqrt{3}}{3} = \frac{\pi}{6};$$

$$\text{б) } \operatorname{arctg} 1 = \frac{\pi}{4};$$

$$\text{в) } \operatorname{arctg} \sqrt{3} = \frac{\pi}{3};$$

$$\text{г) } \operatorname{arctg} 0 = 0.$$

$$17.2. \text{ a) } \operatorname{arctg}(-1) = -\frac{\pi}{4};$$

$$\text{б) } \operatorname{arctg}(-\sqrt{3}) = -\frac{\pi}{3};$$

$$\text{в) } \operatorname{arctg}\left(-\frac{\sqrt{3}}{3}\right) = -\frac{\pi}{6};$$

$$\text{г) } \operatorname{arctg}\left(-\frac{1}{\sqrt{3}}\right) = -\frac{\pi}{6}.$$

$$17.3. \text{ a) } \operatorname{arcctg} \frac{\sqrt{3}}{3} = \frac{\pi}{3};$$

$$\text{б) } \operatorname{arcctg} 1 = \frac{\pi}{4};$$

$$\text{в) } \operatorname{arcctg}\left(-\frac{\sqrt{3}}{3}\right) = \frac{2\pi}{3};$$

$$\text{г) } \operatorname{arcctg} 0 = \frac{\pi}{2}.$$

$$17.4. \text{ a) } \operatorname{arcctg}(-1) + \operatorname{arctg}(-1) = \frac{\pi}{2};$$

$$\text{б) } \arcsin\left(-\frac{\sqrt{2}}{2}\right) + \operatorname{arcctg}(-\sqrt{3}) = \frac{7\pi}{12};$$

$$\text{в) } \operatorname{arcctg}\left(-\frac{\sqrt{3}}{3}\right) - \operatorname{arctg}\left(\frac{\sqrt{3}}{3}\right) = \frac{\pi}{2};$$

$$\text{г) } \arccos\left(-\frac{1}{2}\right) - \operatorname{arcctg}(-\sqrt{3}) = -\frac{\pi}{6}.$$

$$17.5. \text{ a) } \operatorname{tg} x = 1, x = \frac{\pi}{4} + \pi n;$$

$$\text{б) } \operatorname{tg} x = -\frac{\sqrt{3}}{3}, x = -\frac{\pi}{6} + \pi n;$$

$$\text{в) } \operatorname{tg} x = -1, x = -\frac{\pi}{4} + \pi n;$$

$$\text{г) } \operatorname{tg} x = -\frac{\sqrt{3}}{3}, x = -\frac{\pi}{6} + \pi n.$$

17.6. а) $\operatorname{tg} x = 0, x = \pi n;$

б) $\operatorname{tg} x = -2, x = -\operatorname{arctg} 2 + \pi n;$

в) $\operatorname{tg} x = -3, x = -\operatorname{arctg} 3 + \pi n;$

г) $\operatorname{tg} x = \frac{1}{2}, x = \operatorname{arctg} \frac{1}{2} + \pi n.$

17.7. а) $\operatorname{ctg} x = 1, x = \frac{\pi}{4} + \pi n;$

б) $\operatorname{ctg} x = -\sqrt{3}, x = -\frac{\pi}{6} + \pi n;$

в) $\operatorname{ctg} x = 0, x = \frac{\pi}{2} + \pi n;$

г) $\operatorname{ctg} x = -\frac{\sqrt{3}}{3}, x = -\frac{\pi}{3} + \pi n;$

17.8. а) $\operatorname{tg}^2 x - 6\operatorname{tg} x + 5 = 0, \operatorname{tg} x = 5, \operatorname{tg} x = 1,$

$x = \operatorname{arctg} 5 + \pi n, x = \frac{\pi}{4} + \pi n;$

б) $\operatorname{tg}^2 x - 2\operatorname{tg} x - 3 = 0, \operatorname{tg} x = 3, \operatorname{tg} x = -1,$

$x = \operatorname{arctg} 3 + \pi n, x = -\frac{\pi}{4} + \pi n.$

17.9. а) $\operatorname{tg}(\pi + x) = \sqrt{3}, \operatorname{tg} x = \sqrt{3}, x = \frac{\pi}{3} + \pi n;$

б) $2\operatorname{ctg}(2\pi + x) - \operatorname{tg}\left(\frac{\pi}{2} + x\right) = \sqrt{3}, 2\operatorname{ctg} x + \operatorname{ctg} x = \sqrt{3}, \operatorname{ctg} x = \frac{\sqrt{3}}{3}, x = \frac{\pi}{3} + \pi n;$

в) $-\sqrt{3}\operatorname{tg}(\pi - x) = 1, \operatorname{tg} x = \frac{\sqrt{3}}{3}, x = \frac{\pi}{6} + \pi n;$

г) $\operatorname{ctg}(2\pi - x) + \operatorname{ctg}(\pi - x) = 2, \operatorname{ctg} x = -1, x = \frac{3\pi}{4} + \pi n.$

17.10. а)

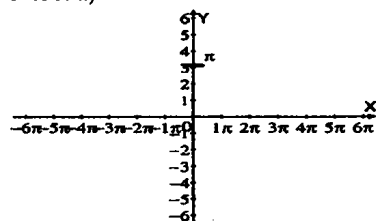

в)

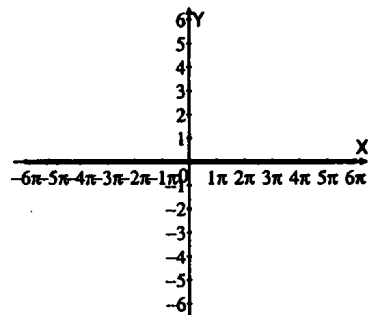

б)

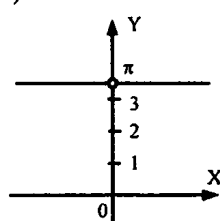

г)

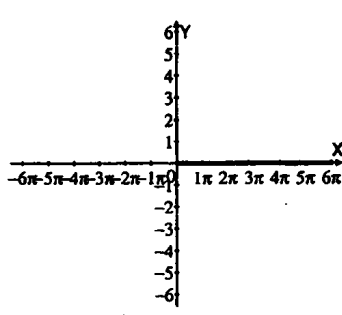

§ 18. Тригонометрические уравнения

18.1. а) $\sin 2x = \frac{\sqrt{2}}{2}$, $2x = (-1)^k \frac{\pi}{4} + \pi k$, $x = (-1)^k \frac{\pi}{8} + \frac{\pi k}{2}$;

б) $\cos \frac{x}{3} = -\frac{1}{2}$, $\frac{x}{3} = \pm \frac{2\pi}{3} + 2\pi n$, $x = \pm 2\pi + 6\pi n$;

в) $\sin \frac{x}{4} = \frac{1}{2}$, $\frac{x}{4} = (-1)^k \frac{\pi}{6} + \pi k$, $x = (-1)^k \frac{2\pi}{3} + 4\pi k$;

г) $\cos 4x = 0$, $4x = \frac{\pi}{2} + \pi n$, $x = \frac{\pi}{8} + \frac{\pi n}{4}$.

18.2. а) $\sin(-\frac{x}{3}) = \frac{\sqrt{2}}{2}$, $\sin \frac{x}{3} = -\frac{\sqrt{2}}{2}$, $\frac{x}{3} = (-1)^{k+1} \frac{\pi}{4} + \pi k$,

$x = (-1)^{k+1} \frac{3\pi}{4} + 3\pi k$;

б) $\cos(-2x) = -\frac{\sqrt{3}}{2}$, $2x = \pm \frac{5\pi}{6} + 2\pi n$, $x = \pm \frac{5\pi}{12} + \pi n$;

в) $\operatorname{tg}(-4x) = \frac{\sqrt{3}}{3}$, $\operatorname{tg} 4x = -\frac{\sqrt{3}}{3}$, $4x = -\frac{\pi}{6} + \pi n$, $x = -\frac{\pi}{24} + \frac{\pi n}{4}$;

г) $\operatorname{ctg}(-\frac{x}{2}) = 1$, $\operatorname{ctg} \frac{x}{2} = -1$, $\frac{x}{2} = -\frac{\pi}{4} + \pi n$, $x = -\frac{\pi}{2} + 2\pi n$.

18.3. а) $2\cos(\frac{\pi}{3} - \frac{\pi}{6}) = \sqrt{3}$, $\frac{x}{2} - \frac{\pi}{6} = \pm \frac{\pi}{6} + 2\pi n$, $x = \pm \frac{\pi}{3} + \frac{\pi}{3} + 4\pi n$;

б) $\sqrt{3} \operatorname{tg}(\frac{x}{3} + \frac{\pi}{6}) = 3$, $\operatorname{tg}(\frac{x}{3} + \frac{\pi}{6}) = \sqrt{3}$, $\frac{x}{3} + \frac{\pi}{6} = \frac{\pi}{3} + \pi n$, $x = \frac{\pi}{2} + 3\pi n$;

в) $2 \sin(3x - \frac{\pi}{4}) = -\sqrt{2}$, $3x - \frac{\pi}{4} = (-1)^{k+1} \frac{\pi}{4} + \pi k$,

$x = (-1)^{k+1} \frac{\pi}{12} + \frac{\pi}{12} + \frac{\pi k}{3}$;

г) $\sin(\frac{x}{2} - \frac{\pi}{6}) + 1 = 0$, $\frac{x}{2} - \frac{\pi}{6} = -\frac{\pi}{2} + 2\pi n$, $x = -\frac{2\pi}{3} + 4\pi n$.

18.4. а) $\cos(\frac{\pi}{6} - 2x) = -1$, $2x - \frac{\pi}{6} = \pi + 2\pi n$, $x = \frac{7\pi}{12} + \pi n$;

б) $\operatorname{tg}(\frac{\pi}{4} - \frac{x}{2}) = -1$, $\frac{x}{2} - \frac{\pi}{4} = \frac{\pi}{4} + \pi n$, $x = \pi + 2\pi n$;

в) $2 \sin(\frac{\pi}{3} - \frac{x}{4}) = \sqrt{3}$, $\frac{x}{4} - \frac{\pi}{3} = (-1)^{n+1} \frac{\pi}{3} + \pi n$, $x = (-1)^{n+1} \frac{4\pi}{3} + \frac{4\pi}{3} + 4\pi n$;

г) $2 \cos(\frac{\pi}{4} - 3x) = \sqrt{2}$, $3x - \frac{\pi}{4} = \pm \frac{\pi}{4} + 2\pi n$, $x = \pm \frac{\pi}{12} + \frac{\pi}{12} + \frac{2\pi n}{3}$.

$$18.5. \text{ а) } \sin\left(\frac{\pi}{2} + t\right) - \cos(\pi + t) = 1, \quad \cos t + \cos t = 1,$$

$$\cos t = \frac{1}{2} \Rightarrow t = \pm \frac{\pi}{3} + 2\pi n, \quad n \in \mathbb{Z}.$$

$$\text{б) } \sin(\pi + t) + \sin(2\pi - t) - \cos\left(\frac{3\pi}{2} + t\right) + 1.5 = 0, \quad -\sin t - \sin t - \sin t = -1.5,$$

$$\sin t = 0.5 \Rightarrow t = (-1)^n \frac{\pi}{6} + \pi n, \quad n \in \mathbb{Z}.$$

$$\text{в) } \cos\left(\frac{\pi}{2} - t\right) - \sin(\pi + t) = \sqrt{2}, \quad \sin t + \sin t = \sqrt{2},$$

$$\sin t = \frac{\sqrt{2}}{2} \Rightarrow t = (-1)^n \frac{\pi}{4} + \pi n, \quad n \in \mathbb{Z}$$

$$\text{г) } \sin(\pi + t) + \cos\left(\frac{\pi}{2} + t\right) = \sqrt{3}, \quad -\sin t - \sin t = \sqrt{3},$$

$$\sin t = -\frac{\sqrt{3}}{2} \Rightarrow t = (-1)^{n+1} \frac{\pi}{3} + \pi n, \quad n \in \mathbb{Z}$$

$$18.6. \text{ а) } 3 \sin^2 x - 5 \sin x - 2 = 0, \quad \sin x = \frac{5+7}{6} \text{ не существует.}$$

$$\sin x = -\frac{1}{3}, \quad x = (-1)^{k+1} \arcsin \frac{1}{3} + \pi k;$$

$$\text{б) } 3 \sin^2 2x + 10 \sin 2x + 3 = 0,$$

$$\sin 2x = \frac{-10 \pm \sqrt{100 - 4 \cdot 3 \cdot 3}}{6} = \frac{-5 \pm 4}{3},$$

$$\sin 2x = \frac{-5-7}{3} \text{ не существует;}$$

$$\sin 2x = -\frac{1}{3}, \quad x = (-1)^{k+1} \frac{\arcsin \frac{1}{3}}{2} + \frac{\pi k}{2};$$

$$\text{в) } 4 \sin^2 x + 11 \sin x - 3 = 0, \quad \sin x = \frac{-11 \pm \sqrt{100 - 4 \cdot 3 \cdot 3}}{6} = \frac{-5 \pm 4}{3},$$

$$\sin x = \frac{-11-13}{8} \text{ не существует; } \sin x = \frac{1}{4}, \quad x = (-1)^n \arcsin \frac{1}{4} + \pi n;$$

$$\text{г) } 2 \sin^2 \frac{x}{2} - 3 \sin \frac{x}{2} + 1 = 0, \quad \sin \frac{x}{2} = \frac{3 \pm \sqrt{9 - 4 \cdot 2 \cdot 1}}{4} = \frac{3 \pm 1}{4},$$

$$\sin \frac{x}{2} = \frac{3+1}{4} = 1, \quad \frac{x}{2} = \frac{\pi}{2} + 2\pi n, \quad x = \pi + 4\pi n; \quad \sin \frac{x}{2} = \frac{1}{4},$$

$$\frac{x}{2} = (-1)^k \frac{\pi}{6} + \pi k, \quad x = (-1)^k \frac{\pi}{3} + 2\pi k.$$

$$18.7. \text{ а) } 6 \cos^2 x + \cos x - 1 = 0,$$

$$\cos x = \frac{-10 \pm \sqrt{100 - 4 \cdot 3 \cdot 3}}{6} = \frac{-5 \pm 4}{3},$$

$$\cos x = -\frac{1}{2}; \quad x = \pm \frac{2}{3}\pi + 2\pi n,$$

$$\cos x = \frac{1}{3}, \quad x = \pm \arccos \frac{1}{3} + 2\pi n;$$

$$\text{б) } 2 \cos^2 3x - 5 \cos 3x - 3 = 0,$$

$$\cos 3x = \frac{5+7}{4} \text{ не существует,}$$

$$\cos 3x = -\frac{1}{2}, \quad 3x = \pm \frac{2\pi}{3} + 2\pi n, \quad x = \pm \frac{2\pi}{9} + \frac{2\pi n}{3}.$$

$$\text{в) } 2 \cos^2 x - \cos x - 3 = 0,$$

$$\cos x = \frac{1+5}{4} \text{ не существует,}$$

$$\cos x = -1, \quad x = \pi + 2\pi n;$$

$$\text{г) } 2 \cos^2 \frac{x}{3} + 3 \cos \frac{x}{3} - 2 = 0,$$

$$\cos \frac{x}{3} = \frac{-3-5}{4} \text{ не существует,}$$

$$\cos \frac{x}{3} = \frac{1}{2}, \quad \frac{x}{3} = \pm \frac{\pi}{3} + 2\pi n, \quad x = \pm \pi + 6\pi n.$$

$$18.8. \text{ а) } 2 \sin^2 x + 3 \cos x = 0,$$

$$2 - 2 \cos^2 x - 3 \cos x - 2 = 0,$$

$$\cos x = \frac{3+5}{4} \text{ не существует,}$$

$$\cos x = -\frac{1}{2}, \quad x = \pm \frac{2\pi}{3} + 2\pi n;$$

$$\text{б) } 8 \sin^2 2x + \cos 2x + 1 = 0,$$

$$8 - 8 \cos^2 2x + \cos 2x + 1 = 0, \quad 8 \cos^2 2x - \cos 2x - 9 = 0;$$

$$\cos 2x = \frac{1+17}{16} \text{ не существует,} \quad \cos 2x = -1, \quad 2x = \pi + 2\pi n, \quad x = \frac{\pi}{2} + \pi n;$$

$$\text{в) } 5 \cos^2 x + 6 \sin x - 6 = 0,$$

$$5 - 5 \sin^2 x + 6 \sin x - 6 = 0, \quad 5 \sin^2 x - 6 \sin x + 1 = 0,$$

$$\sin x = \frac{6 \pm \sqrt{36 - 4 \cdot 5 \cdot 1}}{10} = \frac{3 \pm 2}{5},$$

$$\sin x = 1, \quad x = \frac{\pi}{2} + 2\pi n, \quad \sin x = \frac{1}{5}, \quad x = (-1)^n \arcsin \frac{1}{5} + \pi n;$$

$$\text{г) } 4 \sin 3x + \cos^2 3x = 4,$$

$$\sin^2 3x - 4 \sin 3x + 3 = 0, \quad \sin 3x = 3 \text{ не существует.}$$

$$\sin 3x = 1, \quad 3x = \frac{\pi}{2} + 2\pi n, \quad x = \frac{\pi}{6} + \frac{2\pi n}{3}.$$

$$18.9. \text{ a) } 3 \operatorname{tg}^2 x + 2 \operatorname{tg} x - 1 = 0,$$

$$\operatorname{tg} x = \frac{-1+2}{3} = \frac{1}{3}, \quad x = \operatorname{arctg} \frac{1}{3} + \pi n,$$

$$\operatorname{tg} x = -1, \quad x = -\frac{\pi}{4} + \pi n;$$

$$\text{б) } \operatorname{ctg}^2 2x - 6 \operatorname{ctg} 2x + 5 = 0,$$

$$\operatorname{ctg} 2x = 5, \quad 2x = \operatorname{arctg} 5 + \pi n,$$

$$x = \frac{\operatorname{arctg} 5}{2} + \frac{\pi n}{2}, \quad \operatorname{ctg} 2x = 1, \quad 2x = \frac{\pi}{4} + \pi n, \quad x = \frac{\pi}{8} + \frac{\pi n}{2};$$

$$\text{в) } 2 \operatorname{tg}^2 x + 3 \operatorname{tg} x - 2 = 0,$$

$$\operatorname{tg} x = \frac{-3+5}{4} = \frac{1}{2}, \quad x = \operatorname{arctg} \frac{1}{2} + \pi n, \quad \operatorname{tg} x = -2,$$

$$x = -\operatorname{arctg} 2 + \pi n;$$

$$\text{г) } 7 \operatorname{ctg}^2 \frac{x}{2} + 2 \operatorname{ctg} \frac{x}{2} = 5,$$

$$7 \operatorname{ctg}^2 \frac{x}{2} + 2 \operatorname{ctg} \frac{x}{2} - 5 = 0, \quad \operatorname{ctg} \frac{x}{2} = \frac{-1-6}{7} = -1,$$

$$\frac{x}{2} = -\frac{\pi}{4} + \pi n, \quad x = -\frac{\pi}{2} + 2\pi n,$$

$$\operatorname{ctg} \frac{x}{2} = \frac{-1+6}{7} = \frac{5}{7}, \quad \frac{x}{2} = \operatorname{arctg} \frac{5}{7} + \pi n,$$

$$x = 2 \operatorname{arctg} \frac{5}{7} + 2\pi n.$$

$$18.10. \text{ a) } \sin x + \sqrt{3} \cos x = 0,$$

$$\operatorname{tg} x = -\sqrt{3}, \quad \cos x \neq 0, \quad x = -\frac{\pi}{3} + \pi n;$$

$$\text{б) } \sin x + \cos x = 0,$$

$$\operatorname{tg} x = -1; \quad \cos x \neq 0, \quad x = -\frac{\pi}{4} + \pi n;$$

$$\text{в) } \sin x - 3 \cos x = 0,$$

$$\operatorname{tg} x = 3, \quad \cos x \neq 0, \quad x = \operatorname{arctg} 3 + \pi n;$$

$$\text{г) } \sqrt{3} \sin x + \cos x = 0,$$

$$\operatorname{tg} x = -\frac{\sqrt{3}}{3}, \quad \cos x \neq 0, \quad x = -\frac{\pi}{6} + \pi n.$$

$$18.11. \text{ a) } \sin^2 x + \sin x \cos x = 0,$$

$$\sin x (\sin x + \cos x) = 0, \quad \sin x = 0, \quad x = \pi n,$$

$$\sin x + \cos x = 0, \quad x = -\frac{\pi}{4} + \pi n;$$

$$6) \sqrt{3} \sin x \cos x + \cos^2 x = 0,$$

$$\cos x (\sqrt{3} \sin x + \cos x) = 0, \quad \cos x = 0,$$

$$x = \frac{\pi}{2} + \pi n, \quad \sqrt{3} \sin x + \cos x = 0, \quad x = -\frac{\pi}{6} + \pi n;$$

$$в) \sin^2 x = 3 \sin x \cos x,$$

$$\sin x (\sin x - 3 \cos x) = 0, \quad \sin x = 0, \quad x = \pi n,$$

$$\sin x - 3 \cos x = 0, \quad x = \arctg 3 + \pi n;$$

$$г) \sqrt{3} \cos^2 x = \sin x \cos x,$$

$$\cos x (\sqrt{3} \cos x - \sin x) = 0, \quad \cos x = 0,$$

$$x = \frac{\pi}{2} + \pi n, \quad \sqrt{3} \cos x - \sin x = 0, \quad \operatorname{tg} x = \sqrt{3}, \quad x = \frac{\pi}{3} + \pi n.$$

$$18.12. а) \sin^2 x + 2 \sin x \cos x - 3 \cos^2 x = 0,$$

$$\operatorname{tg}^2 x + 2 \operatorname{tg} x - 3 = 0, \quad \cos x \neq 0, \quad \operatorname{tg} x = -3,$$

$$x = -\arctg 3 + \pi n, \quad \operatorname{tg} x = 1, \quad x = \frac{\pi}{4} + \pi n;$$

$$б) \sin^2 x - 4 \sin x \cos x + 3 \cos^2 x = 0,$$

$$\operatorname{tg}^2 x - 4 \operatorname{tg} x + 3 = 0, \quad \cos x \neq 0; \quad \operatorname{tg} x = 3,$$

$$x = \arctg 3 + \pi n, \quad \operatorname{tg} x = 1, \quad x = \frac{\pi}{4} + \pi n;$$

$$в) \sin^2 x + \sin x \cos x - 2 \cos^2 x = 0,$$

$$\cos x \neq 0, \quad \operatorname{tg}^2 x + \operatorname{tg} x - 2 = 0,$$

$$\operatorname{tg} x = \frac{-1 \pm 3}{2}, \quad \operatorname{tg} x = 1; \quad x = \frac{\pi}{4} + \pi n, \quad \operatorname{tg} x = -2, \quad x = -\arctg 2 + \pi n;$$

$$г) 3 \sin^2 x + \sin x \cos x - 2 \cos^2 x = 0,$$

$$3 \operatorname{tg}^2 x + \operatorname{tg} x - 2 = 0, \quad \cos x \neq 0,$$

$$\operatorname{tg} x = \frac{-1 \pm \sqrt{1 + 4 \cdot 3 \cdot 2}}{6} = \frac{-1 \pm 5}{6},$$

$$\operatorname{tg} x = -1, \quad x = -\frac{\pi}{4} + \pi n, \quad \operatorname{tg} x = \frac{2}{3}, \quad x = \arctg \frac{2}{3} + \pi n.$$

$$18.13. а) \left(\sin x - \frac{1}{2}\right) (\sin x + 1) = 0,$$

$$\sin x = \frac{1}{2}, \quad x = (-1)^k \frac{\pi}{6} + \pi k,$$

$$\sin x = -1, \quad x = -\frac{\pi}{2} + 2\pi n, \quad \text{т.к. } x \in [0, 2\pi] \Rightarrow x = \frac{\pi}{6}, \frac{5\pi}{6}, \frac{3\pi}{2};$$

$$б) \left(\cos x + \frac{1}{2}\right) (\cos x - 1) = 0, \quad \cos x = \frac{1}{2}, \quad x = \pm \frac{2\pi}{3} + 2\pi n, \quad \cos x = 1,$$

$$x = 2\pi n, \quad \text{т.к. } x \in [0, 2\pi] \Rightarrow x = 0, \frac{2\pi}{3}, \frac{4\pi}{3};$$

$$в) \left(\cos x - \frac{\sqrt{2}}{2}\right) \left(\sin x + \frac{\sqrt{2}}{2}\right) = 0,$$

$$\cos x = \frac{\sqrt{2}}{2}, \quad x = \pm \frac{\pi}{4} + 2\pi n.$$

$$\sin x = -\frac{\sqrt{2}}{2}, \quad x = (-1)^{n+1} \frac{\pi}{4} + \pi n, \text{ т.к. } x \in [0, 2\pi] \Rightarrow x = \frac{\pi}{4}, \frac{5\pi}{4}, \frac{7\pi}{4};$$

$$г) (1 + \cos x) \cdot (\sqrt{2} \sin x - 1) = 0,$$

$$\cos x = -1, \quad x = \pi + 2\pi n.$$

$$\sin x = \frac{\sqrt{2}}{2}, \quad x = (-1)^n \frac{\pi}{4} + \pi n, \text{ т.к. } x \in [0, 2\pi] \Rightarrow x = \frac{\pi}{4}, \frac{3\pi}{4}, \pi.$$

$$18.14. а) \frac{\pi}{6}, \frac{5\pi}{6}, \frac{13\pi}{6}, \frac{17\pi}{6}$$

$$б) -\frac{4\pi}{3}, -\frac{2\pi}{3}, \frac{2\pi}{3}, \frac{4\pi}{3}, \frac{8\pi}{3}$$

$$18.15. а) \sin 3x = \frac{\sqrt{2}}{2}, \quad x \in [0; 2\pi];$$

$$3x = (-1)^k \frac{\pi}{4} + \pi k; \quad x = (-1)^k \frac{\pi}{12} + \frac{\pi k}{3}; \quad x = \frac{\pi}{3}, \frac{\pi}{4}, \frac{1}{2}, \frac{11\pi}{12}, \frac{17\pi}{12}, \frac{19\pi}{12};$$

$$б) \cos 3x = \frac{\sqrt{3}}{2}, \quad x \in [-\pi; \pi];$$

$$3x = \pm \frac{\sqrt{2}}{2} + 2\pi n; \quad x = \pm \frac{\pi}{18} + \frac{2\pi n}{3}, \quad x = -\frac{13\pi}{18};$$

$$-\frac{11\pi}{18}; -\frac{5\pi}{6}; \frac{\pi}{18}; \frac{5\pi}{6}; \frac{13\pi}{18};$$

$$в) \operatorname{tg} \frac{x}{2} = \frac{\sqrt{3}}{3}, \quad x \in [-3\pi; 3\pi];$$

$$\frac{x}{2} = \frac{\pi}{6} + \pi n; \quad x = \frac{\pi}{3} + 2\pi n, \quad x = -\frac{5\pi}{3}; \frac{\pi}{3}; \frac{7\pi}{3};$$

$$г) \operatorname{ctg} 4x = -1, \quad x \in [0; \pi];$$

$$4x = -\frac{\pi}{4} + \pi n, \quad x = -\frac{\pi}{16} + \frac{\pi n}{4}; \quad x = \frac{3\pi}{16}; \frac{7\pi}{16}; \frac{11\pi}{16}; \frac{15\pi}{16}.$$

$$18.16. а) \sin 3x = -\frac{1}{2}, \quad x \in [-4; 4];$$

$$3x = (-1)^{k+1} \frac{\pi}{6} + \pi k; \quad x = (-1)^{k+1} \frac{\pi}{18} + \frac{\pi k}{3}; \quad x = -\frac{\pi}{6}; -\frac{5\pi}{6}; \frac{7\pi}{6}.$$

$$б) \cos x = 1, \quad x \in [-6; 16]; \quad x = 2\pi n, \quad x = 0; 2\pi; 4\pi.$$

$$18.17. \text{ a) } \sin \frac{x}{2} = 0, x \in [-12; 18],$$

$$\frac{x}{2} = \pi n, x = -2\pi; 0; 2\pi; 4\pi;$$

$$\text{б) } \cos 3x = \frac{-\sqrt{2}}{2}, x \in [1; 7],$$

$$3x = \pm \frac{3\pi}{4} + 2\pi n, x = \pm \frac{\pi}{4} + \frac{2\pi n}{3},$$

$$x = \frac{11\pi}{12}; \frac{19\pi}{12}; \frac{5}{12}\pi; \frac{13}{12}\pi; \frac{7}{4}\pi.$$

$$18.18. \sin(2x - \frac{\pi}{4}) = -1, 2x - \frac{\pi}{4} = -\frac{\pi}{2} + 2\pi n, x = -\frac{\pi}{8} + \pi n.$$

$$\text{a) } x = \frac{7\pi}{8}; \quad \text{б) } -\frac{\pi}{8}; \frac{7\pi}{8}; \quad \text{в) } -\frac{\pi}{8}; \quad \text{г) } -\frac{\pi}{8}.$$

$$18.19. \cos(\frac{\pi}{3} - 2x) = \frac{1}{2},$$

$$2x - \frac{\pi}{3} = \pm \frac{\pi}{3} + 2\pi n, x = \frac{\pi}{3} + \pi n, x = \pi n.$$

$$\text{a) } \frac{\pi}{3}; \quad \text{б) } 0; \frac{\pi}{3}; \pi; \frac{4\pi}{3}; \quad \text{в) } -\frac{2\pi}{3}; \quad \text{г) } -\frac{2\pi}{3}; 0; \frac{\pi}{3}.$$

$$18.20. \text{ a) } \sin^2 \frac{3x}{4} - \frac{\sqrt{2}}{2} = \sin x - \cos^2 \frac{3x}{4} + 1,$$

$$1 - \frac{\sqrt{2}}{2} - 1 = \sin x, \sin x = -\frac{\sqrt{2}}{2}, x = (-1)^{k+1} \frac{\pi}{4} + \pi k;$$

$$\text{б) } \cos^2 2x - 1 - \cos x = \frac{\sqrt{3}}{2} - \sin^2 2x,$$

$$\cos x = -\frac{\sqrt{3}}{2}, x = \pm \frac{5\pi}{6} + 2\pi n.$$

$$18.21. \text{ a) } \operatorname{tg} x - 2 \operatorname{ctg} x + 1 = 0,$$

$$\operatorname{tg}^2 x + \operatorname{tg} x - 2 = 0, \operatorname{tg} x = -2,$$

$$x = -\operatorname{arctg} 2 + \pi n, \operatorname{tg} x = 1, x = \frac{\pi}{4} + \pi n;$$

$$\text{б) } \frac{\operatorname{tg} x + 5}{2} = \frac{1}{\cos^2 x},$$

$$2 \operatorname{tg}^2 x - \operatorname{tg} x - 3 = 0, \operatorname{tg} x = \frac{1+5}{4} = \frac{3}{2}, x = \operatorname{arctg} \frac{3}{2} + \pi k,$$

$$\operatorname{tg} x = -1; x = -\frac{\pi}{4} + \pi k;$$

$$b) 2 \operatorname{ctg} x - 3 \operatorname{tg} x + 5 = 0,$$

$$2 \operatorname{ctg}^2 x + 5 \operatorname{ctg} x - 3 = 0, \operatorname{ctg} x = \frac{-5+7}{4} = \frac{1}{2},$$

$$x = \operatorname{arccctg} \frac{1}{2} + \pi n, \operatorname{ctg} x = -3, x = -\operatorname{arccctg} 3 + \pi n;$$

$$r) \frac{7 - \operatorname{ctg} x}{4} = \frac{1}{\sin^2 x},$$

$$7 - \operatorname{ctg} x = 4 \operatorname{ctg}^2 x + 4, 4 \operatorname{ctg}^2 x + \operatorname{ctg} x - 3 = 0,$$

$$\operatorname{ctg} x = \frac{-1+7}{8} = \frac{3}{4},$$

$$x = \operatorname{arccctg} \frac{3}{4} + \pi n, \operatorname{ctg} x = -1, x = -\frac{\pi}{4} + \pi n.$$

$$18.22. a) 2 \cos^2 \frac{x}{2} + \sqrt{3} \cos \frac{x}{2} = 0,$$

$$\cos \frac{x}{2} (2 \cos \frac{x}{2} + \sqrt{3}) = 0, \cos \frac{x}{2} = 0, \frac{x}{2} = \frac{\pi}{2} + \pi k, x = \pi + 2\pi k,$$

$$\cos = \frac{\sqrt{3}}{2}, \frac{x}{2} = \pm \frac{5\pi}{6} + 2\pi n, x = \pm \frac{5}{3}\pi + 4\pi n;$$

$$b) 4 \cos^2 (x - \frac{\pi}{6}) - 3 = 0,$$

$$\cos (x - \frac{\pi}{6}) = \pm \frac{\sqrt{3}}{2}, x - \frac{\pi}{6} = \pm \frac{\pi}{6} + 2\pi n, x = \frac{\pi}{3} + 2\pi n, x = 2\pi n,$$

$$x - \frac{\pi}{6} = \pm \frac{5\pi}{6} + 2\pi n, x = \pi + 2\pi n, x = -\frac{2}{3}\pi + 2\pi n, \Rightarrow x = \frac{\pi}{3} + \pi n, x = \pi n;$$

$$b) \sqrt{3} \operatorname{tg}^2 3x - 3 \operatorname{tg} 3x = 0,$$

$$\operatorname{tg} 3x (\sqrt{3} \operatorname{tg} 3x - 3) = 0, \operatorname{tg} 3x = 0,$$

$$3x = \pi n, x = \frac{\pi n}{3}, \operatorname{tg} 3x = \sqrt{3}, 3x = \frac{\pi}{3} + \pi n, x = \frac{\pi}{9} + \frac{\pi n}{3};$$

$$r) 4 \sin^2 (2x + \frac{\pi}{3}) - 1 = 0,$$

$$\sin (2x + \frac{\pi}{3}) = \pm \frac{1}{2}, 2x + \frac{\pi}{3} = (-1)^n \frac{\pi}{6} + \pi n,$$

$$x = (-1)^n \frac{\pi}{12} - \frac{\pi}{6} + \frac{\pi n}{2},$$

$$2x + \frac{\pi}{3} = (-1)^{n+1} \frac{\pi}{6} + \pi n, x = (-1)^{n+1} \frac{\pi}{12} - \frac{\pi}{6} + \frac{\pi n}{2} \Rightarrow x = -\frac{\pi}{12} + \frac{\pi k}{2};$$

$$x = -\frac{\pi}{4} + \frac{\pi n}{2}.$$

$$18.23. \text{ a) } \sin^2 x - \frac{12 - \sqrt{2}}{2} \cdot \sin x - 3\sqrt{2} = 0,$$

$\sin x = 6$, не существует.

$$\sin x = -\frac{\sqrt{2}}{2}, \quad x = (-1)^{k+1} \frac{\pi}{4} + \pi k;$$

$$\text{б) } \cos^2 x - \frac{8 - \sqrt{3}}{2} \cos x - 2\sqrt{3} = 0,$$

$\cos x = 4$, не существует.

$$\cos x = -\frac{\sqrt{2}}{2}, \quad x = \pm \frac{5\pi}{6} + 2\pi n.$$

$$18.24. \text{ a) } \sin 2x = \cos 2x, \quad \operatorname{tg} 2x = 1, \quad \cos 2x \neq 0, \quad 2x = \frac{\pi}{4} + \pi n, \quad x = \frac{\pi}{8} + \frac{\pi n}{2};$$

$$\text{б) } \sqrt{3} \sin 3x = \cos 3x, \quad \operatorname{ctg} 3x = \sqrt{3}, \quad \sin 3x \neq 0, \quad 3x = \frac{\pi}{6} + \pi n, \quad x = \frac{\pi}{18} + \frac{\pi n}{3};$$

$$\text{в) } \sin \frac{x}{2} = \sqrt{3} \cos \frac{x}{2}, \quad \operatorname{tg} \frac{x}{2} = \sqrt{3}, \quad \cos \frac{x}{2} \neq 0, \quad \frac{x}{2} = \frac{\pi}{3} + \pi n, \quad x = \frac{2}{3} \pi + 2\pi n;$$

$$\text{г) } \sqrt{2} \sin 17x = \sqrt{6} \cos 17x, \quad \operatorname{tg} 17x = \sqrt{3}, \quad \cos 17x \neq 0, \quad 17x = \frac{\pi}{3} + \pi n, \quad x = \frac{\pi}{51} + \frac{\pi n}{17}.$$

$$18.25. \text{ a) } 2 \sin^2 2x - 5 \sin 2x \cos 2x + 2 \cos^2 2x = 0,$$

$$2 \operatorname{tg}^2 2x - 5 \operatorname{tg} 2x + 2 = 0, \quad \cos 2x \neq 0,$$

$$\operatorname{tg} 2x = \frac{5 \pm 3}{4}, \quad \operatorname{tg} 2x = 2;$$

$$x = \frac{1}{2} \operatorname{arctg} 2 + \frac{\pi n}{2}, \quad \operatorname{tg} 2x = \frac{1}{2}, \quad x = \frac{1}{2} \operatorname{arctg} \frac{1}{2} + \frac{\pi n}{2};$$

$$\text{б) } 3 \sin^2 3x + 10 \sin 3x \cos 3x + 3 \cos^2 3x = 0,$$

$$3 \operatorname{tg}^2 3x + 10 \operatorname{tg} 3x + 3 = 0, \quad \operatorname{tg} 3x = \frac{-10 \pm \sqrt{100 - 4 \cdot 3 \cdot 3}}{6} = \frac{-10 \pm 8}{6},$$

$$\operatorname{tg} 3x = -3; \quad x = \frac{1}{3} \operatorname{arctg}(-3) + \frac{1}{3} \pi n, \quad \operatorname{tg} 3x = -\frac{1}{3}; \quad x = \frac{1}{3} \operatorname{arctg}\left(-\frac{1}{3}\right) + \frac{1}{3} \pi n.$$

$$18.26. \text{ a) } \sin^2 \frac{x}{2} = 3 \cos^2 \frac{x}{2},$$

$$\cos^2 \frac{x}{2} = \frac{1}{4}, \quad \cos \frac{x}{2} = \pm \frac{1}{2}, \quad \frac{x}{2} = \pm \frac{\pi}{3} + \pi k; \quad x = \pm \frac{2\pi}{3} + 2\pi k;$$

$$\text{б) } \sin^2 4x = \cos^2 4x,$$

$$\operatorname{tg}^2 4x = 1, \quad \cos 4x \neq 0, \quad \operatorname{tg} 4x = \pm 1,$$

$$4x = \frac{\pi}{4} + \pi n, \quad x = \frac{\pi}{16} + \frac{\pi n}{4}, \quad 4x = -\frac{\pi}{4} + \pi n, \quad x = -\frac{\pi}{16} + \frac{\pi n}{4} \Rightarrow$$

$$x = \pm \frac{\pi}{16} + \frac{\pi n}{4}.$$

$$18.27. \text{ a) } 5 \sin^2 x - 14 \sin x \cos x - 3 \cos^2 x = 2, \\ 3 \sin^2 x - 14 \sin x \cos x - 5 \cos^2 x = 0, \quad 3 \operatorname{tg}^2 x - 14 \operatorname{tg} x - 5 = 0, \quad \cos x \neq 0, \\ \operatorname{tg} x = \frac{7+8}{3} = 5, \quad x = \operatorname{arctg} 5 + \pi k, \quad \operatorname{tg} x = -\frac{1}{3}, \quad x = -\operatorname{arctg} \frac{1}{3} + \pi k;$$

$$\text{б) } 3 \sin^2 x - \sin x \cos x = 2, \\ \sin^2 x - \sin x \cos x - 2 \cos^2 x = 0, \quad \operatorname{tg}^2 x - \operatorname{tg} x - 2 = 0,$$

$$\cos x \neq 0, \quad \operatorname{tg} x = 2, \quad x = \operatorname{arctg} 2 + \pi n, \quad \operatorname{tg} x = -1; \quad x = -\frac{\pi}{4} + \pi n.$$

$$\text{в) } 2 \cos^2 x - \sin x \cos x + 5 \sin^2 x = 3, \\ 2 \sin^2 x - \sin x \cos x - \cos^2 x = 0,$$

$$2 \operatorname{tg}^2 x - \operatorname{tg} x - 1 = 0, \quad \cos x \neq 0, \quad \operatorname{tg} x = 1, \quad x = \frac{\pi}{4} + \pi k,$$

$$\operatorname{tg} x = -\frac{1}{2}, \quad x = -\operatorname{arctg} \frac{1}{2} + \pi k;$$

$$\text{г) } 4 \sin^2 x - 2 \sin x \cos x = 3, \\ \sin^2 x - 2 \sin x \cos x - 3 \cos^2 x = 0,$$

$$\operatorname{tg}^2 x - 2 \operatorname{tg} x - 3 = 0, \quad \cos x \neq 0, \quad \operatorname{tg} x = -1, \quad x = -\frac{\pi}{4} + \pi k,$$

$$\operatorname{tg} x = 3, \quad x = \operatorname{arctg} 3 + \pi k.$$

$$18.28. \text{ a) } \sqrt{3} \sin x \cos x + \cos^2 x = 0,$$

$$\cos x (\sqrt{3} \sin x + \cos x) = 0, \quad \cos x = 0,$$

$$x = \frac{\pi}{2} + \pi n, \quad \sqrt{3} \sin x + \cos x = 0, \quad \sqrt{3} \operatorname{tg} x = -1, \quad \operatorname{tg} x = -\frac{\sqrt{3}}{3}, \quad x = -\frac{\pi}{6} + \pi n;$$

$$\text{б) } 2 \sin^2 x - 3 \sin x \cos x + 4 \cos^2 x = 4,$$

$$-3 \sin x \cos x = 2 - 2 \cos^2 x,$$

$$-3 \sin x \cos x = 2 \sin^2 x, \quad \sin x (3 \cos x + 2 \sin x) = 0, \quad \sin x = 0, \quad x = \pi n,$$

$$3 \cos x + 2 \sin x = 0, \quad \operatorname{tg} x = -\frac{3}{2}, \quad \cos x \neq 0, \quad x = -\operatorname{arctg} \frac{3}{2} + \pi n.$$

$$18.29. \text{ a) } 3 \sin^2 2x - 2 = \sin 2x \cos 2x,$$

$$\sin^2 2x - \sin 2x \cos 2x - 2 \cos^2 2x = 0,$$

$$\operatorname{tg}^2 2x - \operatorname{tg} 2x - 2 = 0, \quad \cos^2 2x \neq 0, \quad \operatorname{tg} 2x = 2, \quad 2x = \operatorname{arctg} 2 + \pi n,$$

$$x = \frac{1}{2} \operatorname{arctg} 2 + \frac{\pi n}{2}, \quad \operatorname{tg} 2x = -1, \quad 2x = -\frac{\pi}{4} + \pi n, \quad x = -\frac{\pi}{8} + \frac{\pi n}{2};$$

$$\text{б) } 2 \sin^2 4x - 4 = 3 \sin 4x \cos 4x - 4 \cos^2 4x,$$

$$2 + 2 \cos^2 4x - 4 = 3 \sin 4x \cos 4x,$$

$$2 \sin^2 4x + 3 \sin 4x \cos 4x = 0, \quad \sin 4x (2 \sin 4x + 3 \cos 4x) = 0, \quad \sin 4x = 0,$$

$$4x = \pi n, \quad x = \frac{\pi n}{4}, \quad 2 \sin 4x + 3 \cos 4x = 0, \quad 2 \operatorname{tg} 4x = -3, \quad \cos 4x \neq 0,$$

$$x = -\frac{1}{4} \operatorname{arctg} \frac{3}{2} + \frac{\pi n}{4}.$$

$$18.30. \text{ a) } 4 \sin^2 \frac{x}{2} - 3 = 2 \sin \frac{x}{2} \cos \frac{x}{2},$$

$$\sin^2 \frac{x}{2} - 2 \sin \frac{x}{2} \cos \frac{x}{2} - 3 \cos^2 \frac{x}{2} = 0, \quad \operatorname{tg}^2 \frac{x}{2} - 2 \operatorname{tg} \frac{x}{2} - 3 = 0; \quad \cos \frac{x}{2} \neq 0.$$

$$\operatorname{tg} \frac{x}{2} = -1, \quad x = -\frac{\pi}{2} + 2\pi n, \quad \operatorname{tg} \frac{x}{2} = 3, \quad x = 2 \operatorname{arctg} 3 + 2\pi n;$$

$$\text{б) } 3 \sin^2 \frac{x}{3} + 4 \cos^2 \frac{x}{3} = 3 + \sqrt{3} \sin \frac{x}{3} \cos \frac{x}{3},$$

$$\cos^2 \frac{x}{3} - \sqrt{3} \sin \frac{x}{3} \cos \frac{x}{3} = 0,$$

$$\cos \frac{x}{3} (\cos \frac{x}{3} - \sqrt{3} \sin \frac{x}{3}) = 0, \quad \cos \frac{x}{3} = 0, \quad \frac{x}{3} = \frac{\pi}{2} + \pi n, \quad x = \frac{3\pi}{2} + 3\pi n,$$

$$\cos \frac{x}{3} - \sqrt{3} \sin \frac{x}{3} = 0, \quad \operatorname{ctg} \frac{x}{3} = \sqrt{3}, \quad \sin \frac{x}{3} \neq 0,$$

$$\frac{x}{3} = \frac{\pi}{6} + \pi n, \quad x = \frac{\pi}{2} + 3\pi n.$$

$$18.31. \text{ a) } \sin \left(\frac{\pi}{2} + 2x \right) + \cos \left(\frac{\pi}{2} - 2x \right) = 0,$$

$$\cos 2x + \sin 2x = 0,$$

$$\operatorname{tg} 2x = -1, \quad \cos 2x \neq 0, \quad 2x = -\frac{\pi}{4} + \pi n, \quad x = -\frac{\pi}{8} + \frac{\pi n}{2};$$

$$\text{б) } 2 \sin (\pi - 3x) + \cos (2\pi - 3x) = 0,$$

$$2 \sin 3x + \cos 3x = 0,$$

$$\operatorname{tg} 3x = -\frac{1}{2}, \quad \cos 3x \neq 0, \quad 3x = -\operatorname{arctg} \frac{1}{2} + \pi n, \quad x = -\frac{1}{3} \operatorname{arctg} \frac{1}{2} + \frac{\pi n}{3}.$$

$$18.32. \text{ a) } \cos \left(\frac{\pi}{2} - \frac{x}{2} \right) - 3 \cos \left(\pi - \frac{x}{2} \right) = 0,$$

$$\sin \frac{x}{2} + 3 \cos \frac{x}{2} = 0,$$

$$\operatorname{tg} \frac{x}{2} = -3, \quad \cos \frac{x}{2} \neq 0, \quad \frac{x}{2} = -\operatorname{arctg} 3 + \pi n, \quad x = -2 \operatorname{arctg} 3 + 2\pi n;$$

$$\text{б) } \sqrt{3} \sin \left(\pi - \frac{x}{2} \right) + 3 \sin \left(\frac{\pi}{2} - \frac{x}{3} \right) = 0,$$

$$\sqrt{3} \sin \frac{x}{2} + 3 \cos \frac{x}{3} = 0, \quad \operatorname{tg} \frac{x}{2} = -\sqrt{3}, \quad \cos \frac{x}{3} \neq 0, \quad x = -\pi + 3\pi n.$$

$$18.33. \text{ a) } \sqrt{16 - x^2} \sin x = 0,$$

$$|x| \leq 4, \quad x = 4, \quad x = -4, \quad \sin x = 0, \quad x = \pi n, \quad n = 0, \pm 1.$$

$$\text{Ответ: } x = 0, \pm 4; \pm \pi.$$

$$6) \sqrt{7x-x^2}(2\cos x-1)=0,$$

$$0 \leq x \leq 7, \quad 7x-x^2=0, \quad x=0, \quad x=7,$$

$$2\cos x-1=0, \quad \cos x=\frac{1}{2}, \quad x=\frac{\pi}{3}, \quad x=\frac{5\pi}{3}.$$

$$\text{Ответ: } x=0; \frac{\pi}{3}; \frac{5\pi}{3}; 7.$$

$$18.34. \text{ а) } (\sqrt{2} \cos x - 1) \cdot \sqrt{4x^2 - 7x + 3} = 0, \quad 4x^2 - 7x + 3 \geq 0,$$

$$x \geq \frac{7+1}{8} = 1, \quad x \leq \frac{3}{4}, \quad \sqrt{2} \cos x - 1 = 0, \quad x = \pm \frac{\pi}{4} + 2\pi n.$$

$$\text{Ответ: } x=1, \quad x=\frac{3}{4}, \quad x=-\frac{\pi}{4}; \quad x=\pm \frac{\pi}{4} + 2\pi n. \quad n=\pm 1; \pm 2; \pm 3 \dots$$

$$6) (2\sin x - \sqrt{3})\sqrt{3x^2 - 7x + 4} = 0;$$

$$3x^2 - 7x + 4 \geq 0; \quad x \leq 1; \quad x \geq \frac{4}{3}$$

$$2\sin x - \sqrt{3} = 0, \quad \sin x = \frac{\sqrt{3}}{2}, \quad x = \frac{2\pi}{3} + 2\pi k; \quad x = \frac{\pi}{3} + 2\pi k; \quad k = \pm 1, \pm 2, \dots;$$

$$3x^2 - 7x + 4 = 0 \quad x=1; \quad x=\frac{4}{3}.$$

$$\text{Ответ: } 1; \frac{4}{3}; \frac{2\pi}{3} + 2\pi k; \frac{\pi}{3} + 2\pi k; k = \pm 1; \pm 2; \dots$$

$$18.35. \text{ а) } y = \cos 3x + \sqrt{\cos^2 3x - 1} = \cos 3x + \sqrt{-\sin^2 3x},$$

$$\sin^2 3x \geq 0, \quad \sin 3x = 0, \quad x = \frac{\pi n}{3}.$$

Область значений функции: $\{-1; 1\}$.

$$6) y = \sin 2x + \sqrt{\sin^2 4x - 1} = \sin 2x + \sqrt{-\cos^2 4x},$$

$$\cos^2 4x \geq 0, \quad \cos 4x = 0,$$

$$x = \frac{\pi}{8} + \frac{\pi n}{4}, \quad 2x = \frac{\pi}{4} + \frac{\pi n}{2}.$$

Область значений функции: $\{\frac{\sqrt{2}}{2}, -\frac{\sqrt{2}}{2}\}$.

Глава 4. Преобразование тригонометрических выражений

§ 19. Синус и косинус суммы и разности аргументов

$$19.1. \text{ а) } \sin 105^\circ = \sin (60^\circ + 45^\circ) = \sin 60^\circ \cos 45^\circ + \sin 45^\circ \cos 60^\circ = \\ = \frac{\sqrt{3}}{2} \cdot \frac{\sqrt{2}}{2} + \frac{\sqrt{2}}{2} \cdot \frac{1}{2} = \frac{\sqrt{6} + \sqrt{2}}{4};$$

$$\text{б) } \cos 105^\circ = \cos (60^\circ + 45^\circ) = \frac{1}{2} \cdot \frac{\sqrt{2}}{2} - \frac{\sqrt{3}}{2} \cdot \frac{\sqrt{2}}{2} = \frac{\sqrt{2} - \sqrt{6}}{4}.$$

$$19.2. \text{ а) } \sin (\alpha + \beta) - \sin \alpha \cos \beta = \sin \alpha \cos \beta + \sin \beta \cos \alpha - \sin \alpha \cos \beta = \\ = \sin \beta \cos \alpha.$$

$$\text{б) } \sin \left(\frac{\pi}{3} + \alpha \right) - \frac{1}{2} \sin \alpha = \sin \frac{\pi}{3} \cos \alpha + \cos \frac{\pi}{3} \sin \alpha - \frac{1}{2} \sin \alpha = \\ = \frac{\sqrt{3}}{2} \cos \alpha.$$

$$\text{в) } \sin \alpha \sin \beta + \cos (\alpha + \beta) = \sin \alpha \sin \beta + \cos \alpha \cos \beta - \sin \alpha \sin \beta = \cos \alpha \cos \beta.$$

$$\text{г) } \cos \left(\alpha + \frac{\pi}{4} \right) + \frac{\sqrt{2}}{2} \sin \alpha = \frac{\sqrt{2}}{2} \cos \alpha - \frac{\sqrt{2}}{2} \sin \alpha + \frac{\sqrt{2}}{2} \sin \alpha = \frac{\sqrt{2}}{2} \cos \alpha.$$

$$19.3. \text{ а) } \sin \left(\frac{5\pi}{6} - \alpha \right) - \frac{1}{2} \cos \alpha = \sin \frac{5\pi}{6} \cos \alpha - \sin \alpha \cos \frac{5\pi}{6} - \frac{1}{2} \cos \alpha = \\ = \frac{1}{2} \cos \alpha + \frac{\sqrt{3}}{2} \sin \alpha - \frac{1}{2} \cos \alpha = \frac{\sqrt{3}}{2} \sin \alpha.$$

$$\text{б) } \sqrt{3} \cos \alpha - 2 \cos \left(\alpha - \frac{\pi}{6} \right) = \sqrt{3} \cos \alpha - 2 \cos \alpha \cos \frac{\pi}{6} + 2 \sin \alpha \sin \frac{\pi}{6} = -\sin \alpha.$$

$$\text{в) } \frac{\sqrt{3}}{2} \sin \alpha + \cos \left(\alpha - \frac{5\pi}{3} \right) = \frac{\sqrt{3}}{2} \sin \alpha + \cos \alpha \cos \frac{5\pi}{3} + \sin \alpha \sin \frac{5\pi}{3} = \frac{1}{2} \cos \alpha.$$

$$\text{г) } \sqrt{2} \sin \left(\alpha - \frac{\pi}{4} \right) - \sin \alpha = \sqrt{2} \sin \alpha \cos \frac{\pi}{4} - \sqrt{2} \cos \alpha \sin \frac{\pi}{4} - \sin \alpha = -\cos \alpha.$$

$$19.4. \text{ а) } \cos (\alpha - \beta) - \cos \alpha \cos \beta = \cos \alpha \cos \beta + \sin \alpha \sin \beta - \cos \alpha \cos \beta = \\ = \sin \alpha \sin \beta$$

$$\text{б) } \sin (\alpha + \beta) + \sin (\alpha - \beta) = \sin \alpha \cos \beta + \sin \beta \cos \alpha + \sin \alpha \cos \beta - \sin \beta \cos \alpha = \\ = 2 \sin \alpha \cos \beta$$

$$\text{в) } \sin \alpha \cos \beta - \sin (\alpha - \beta) = \sin \alpha \cos \beta - \sin \alpha \cos \beta + \sin \beta \cos \alpha = \\ = \sin \beta \cos \alpha$$

$$\text{г) } \cos (\alpha - \beta) - \cos (\alpha + \beta) = \cos \alpha \cos \beta + \sin \alpha \sin \beta - \cos \alpha \cos \beta + \sin \alpha \sin \beta = \\ = 2 \sin \alpha \sin \beta.$$

19.5. а) $\sin(\alpha + \beta) + \sin(-\alpha)\cos(-\beta) = \sin\alpha\cos\beta + \sin\beta\cos\alpha - \sin\alpha\cos\beta = \sin\beta\cos\alpha$, т.е. тождество верно.

б) $\cos(\alpha + \beta) + \sin(-\alpha)\sin(-\beta) = \cos\alpha\cos\beta$.

$\cos(\alpha + \beta) + \sin(-\alpha)\sin(-\beta) = \cos\alpha\cos\beta - \sin\alpha\sin\beta + \sin\alpha\sin\beta = \cos\alpha\cos\beta$

19.6. а) $\frac{\sqrt{3}}{2}\cos x - \frac{1}{2}\sin x = \sin\frac{\pi}{3}\cos x - \cos\frac{\pi}{3}\sin x = \sin\left(\frac{\pi}{3} - x\right)$

б) $\frac{1}{2}\cos x + \frac{\sqrt{3}}{2}\sin x = \cos\frac{\pi}{3}\cos x + \sin\frac{\pi}{3}\sin x = \cos\left(\frac{\pi}{3} - x\right)$

19.7. а) $\cos(\alpha - \beta) + \sin(-\alpha)\sin\beta = \cos\alpha\cos\beta$,

$\cos\alpha\cos\beta + \sin\alpha\sin\beta - \sin\alpha\sin\beta = \cos\alpha\cos\beta$;

б) $\sin(30^\circ - \alpha) + \sin(30^\circ + \alpha) = \cos\alpha$,

$\frac{1}{2}\cos\alpha - \frac{\sqrt{3}}{2}\sin\alpha + \frac{1}{2}\cos\alpha + \frac{\sqrt{3}}{2}\sin\alpha = \cos\alpha$.

19.8. а) $\sin 5x\cos 3x + \cos 5x\sin 3x = \sin 8x$, $\sin(5x + 3x) = \sin 8x$;

б) $\cos 5x\cos 3x - \sin 5x\sin 3x = \cos 8x$, $\cos(5x + 3x) = \cos 8x$;

19.9. а) $\sin 7x\cos 4x - \cos 7x\sin 4x = \sin(7x - 4x) = \sin 3x$

б) $\cos 2x\cos 12x + \sin 2x\sin 12x = \cos(2x - 12x) = \cos 10x$

19.10. а) $\cos 107^\circ\cos 17^\circ + \sin 107^\circ\sin 17^\circ = \cos(107^\circ - 17^\circ) = \cos 90^\circ = 0$.

б) $\cos 36^\circ\cos 24^\circ - \sin 36^\circ\sin 24^\circ = \cos(36^\circ + 24^\circ) = \cos 60^\circ = \frac{1}{2}$.

в) $\sin 63^\circ\cos 27^\circ + \cos 63^\circ\sin 27^\circ = \sin(63^\circ + 27^\circ) = \sin 90^\circ = 1$.

г) $\sin 51^\circ\cos 21^\circ - \cos 51^\circ\sin 21^\circ = \sin(51^\circ - 21^\circ) = \frac{1}{2}$.

19.11. а) $\cos\frac{5\pi}{8}\cos\frac{3\pi}{8} + \sin\frac{5\pi}{8}\sin\frac{3\pi}{8} = \cos\left(\frac{5\pi}{8} - \frac{3\pi}{8}\right) = \cos\frac{\pi}{4} = \frac{\sqrt{2}}{2}$.

б) $\sin\frac{2\pi}{15}\cos\frac{\pi}{5} + \cos\frac{2\pi}{15}\sin\frac{\pi}{5} = \sin\left(\frac{2\pi}{15} + \frac{\pi}{5}\right) = \sin\frac{\pi}{3} = \frac{\sqrt{3}}{2}$.

в) $\cos\frac{\pi}{12}\cos\frac{\pi}{4} - \sin\frac{\pi}{12}\sin\frac{\pi}{4} = \cos\left(\frac{\pi}{12} + \frac{\pi}{4}\right) = \cos\frac{\pi}{3} = \frac{1}{2}$.

г) $\sin\frac{\pi}{12}\cos\frac{\pi}{4} - \cos\frac{\pi}{12}\sin\frac{\pi}{4} = \sin\left(\frac{\pi}{12} - \frac{\pi}{4}\right) = -\sin\frac{\pi}{6} = -\frac{1}{2}$.

19.12. а) $\sin 2x\cos x + \cos 2x\sin x = 1$, $\sin 3x = 1$,

$3x = \frac{\pi}{2} + 2\pi n$, $x = \frac{\pi}{6} + \frac{2\pi n}{3}$;

б) $\cos 3x\cos 5x = \sin 3x\sin 5x$, $\cos 3x\cos 5x - \sin 3x\sin 5x = 0$,

$\cos 8x = 0$, $8x = \frac{\pi}{2} + \pi n$, $x = \frac{\pi}{16} + \frac{\pi n}{8}$.

$$19.13. \text{ a) } \sin 6x \cos x + \cos 6x \sin x = \frac{1}{2}, \quad \sin 7x = \frac{1}{2},$$

$$7x = (-1)^k \frac{\pi}{6} + \pi k, \quad x = (-1)^k \frac{\pi}{42} + \frac{\pi k}{7};$$

$$\text{б) } \cos 5x \cos 7x - \sin 5x \sin 7x = -\frac{\sqrt{3}}{2}, \quad \cos 12x = -\frac{\sqrt{3}}{2},$$

$$12x = \pm \frac{5\pi}{6} + 2\pi n, \quad x = \pm \frac{5\pi}{72} + \frac{\pi n}{6}.$$

$$19.14. \text{ a) } \cos 6x \cos 5x + \sin 6x \sin 5x = -1, \\ \cos(6x - 5x) = -1, \quad \cos x = -1, \quad x = \pi + 2\pi n;$$

$$\text{б) } \sin 3x \cos 5x - \sin 5x \cos 3x = \frac{1}{2},$$

$$\sin(3x - 5x) = \frac{1}{2}, \quad \sin 2x = -\frac{1}{2},$$

$$2x = (-1)^{k+1} \frac{\pi}{6} + \pi k, \quad x = (-1)^{k+1} \frac{\pi}{12} + \frac{\pi k}{2}.$$

$$19.15. \text{ a) } \sin x \cos 45^\circ + \cos x \sin 45^\circ = \cos 17^\circ \cos 13^\circ - \sin 17^\circ \sin 13^\circ$$

$$\sin(x + 45^\circ) = \cos 30^\circ = \frac{\sqrt{3}}{2}$$

$$x + 45^\circ = (-1)^n 60^\circ + 180^\circ \cdot n, \quad n \in \mathbb{Z}; \quad x = 15^\circ$$

$$\text{б) } \cos x \cos 60^\circ - \sin x \sin 60^\circ = \sin 200^\circ \cos 25^\circ + \cos 200^\circ \sin 25^\circ;$$

$$\cos(x + 60^\circ) = \sin(225^\circ) = -\frac{\sqrt{2}}{2}; \quad x = 75^\circ$$

$$19.16. \text{ a) } \sin 0,2x \cos 0,8x + \cos 0,2x \sin 0,8x = \cos 3x \cos 2x + \sin 3x \sin 2x, \\ x \in [0, 3\pi]$$

$$\sin(0,2x + 0,8x) = \cos(3x - 2x), \quad \sin x = \cos x$$

$$x = \frac{\pi}{4} + \pi n, \quad x = \frac{\pi}{4}, \frac{5\pi}{4}, \frac{9\pi}{4};$$

$$\text{б) } \cos 0,7x \cos 1,3x - \sin 0,7x \sin 1,3x = \sin 7x \cos 9x - \sin 9x \cos 7x, \\ x \in [-\pi, \pi]$$

$$\cos(0,7x + 1,3x) = \sin(7x - 9x), \quad \cos 2x = -\sin 2x; \quad \operatorname{tg} 2x = -1, \quad \cos 2x \neq 0,$$

$$x = -\frac{\pi}{8} + \frac{\pi n}{2}, \quad x = -\frac{5\pi}{8}, -\frac{\pi}{8}, \frac{3\pi}{8}, \frac{7\pi}{8}.$$

$$19.17. \sin t = \frac{3}{5}, \quad 0 < t < \frac{\pi}{2}, \quad \cos t = \frac{4}{5}.$$

$$\text{a) } \sin\left(\frac{\pi}{3} + t\right) = \sin \frac{\pi}{3} \cos t + \sin t \cos \frac{\pi}{3} = \frac{\sqrt{3}}{2} \cdot \frac{4}{5} + \frac{1}{2} \cdot \frac{3}{5} =$$

$$\frac{2\sqrt{3}}{5} + \frac{3}{10} = \frac{4\sqrt{3} + 3}{10}.$$

$$б) \cos\left(\frac{\pi}{2} + t\right) = -\sin t = -\frac{3}{5};$$

$$в) \sin\left(\frac{\pi}{2} + t\right) = \cos t = \frac{4}{5};$$

$$г) \cos\left(\frac{\pi}{3} + t\right) = \cos\frac{\pi}{3} \cos t - \sin\frac{\pi}{3} \sin t = \frac{1}{2} \cdot \frac{4}{5} - \frac{\sqrt{3}}{2} \cdot \frac{3}{5} = \frac{4-3\sqrt{3}}{10}.$$

$$19.18. а) \sin\left(t - \frac{\pi}{6}\right) = \frac{\sqrt{3}}{2} \sin t - \frac{1}{2} \cos t = \frac{\sqrt{3}}{2} \sqrt{1 - \cos^2 t} + \frac{5}{26} = \frac{5 + 12\sqrt{3}}{26}$$

$$б) \cos\left(t - \frac{3\pi}{2}\right) = -\sin t = -\sqrt{1 - \cos^2 t} = -\frac{12}{13}$$

$$в) \cos\left(t - \frac{\pi}{6}\right) = \frac{\sqrt{3}}{2} \cos t + \frac{1}{2} \sin t = -\frac{5\sqrt{3}}{26} + \frac{1}{2} \sqrt{1 - \cos^2 t} = \frac{12 - 5\sqrt{3}}{26}$$

$$г) \sin\left(t - \frac{3\pi}{2}\right) = \cos t = -\frac{5}{13}$$

$$19.19. а) \sin(\alpha - \beta) = \sin \alpha \cos \beta - \cos \alpha \sin \beta =$$

$$= \frac{4}{5} \sqrt{1 - \cos^2 \alpha} - \frac{15}{17} \sqrt{1 - \cos^2 \beta} = \frac{4}{5} \cdot \frac{8}{17} - \frac{15}{17} \cdot \frac{3}{5} = -\frac{13}{85}$$

$$б) \cos(\alpha - \beta) = \cos \alpha \cos \beta + \sin \alpha \sin \beta =$$

$$= \frac{15}{17} \cdot \frac{4}{5} + \sqrt{1 - \cos^2 \alpha} \sqrt{1 - \cos^2 \beta} = \frac{60}{85} + \frac{8}{17} \cdot \frac{3}{5} = \frac{84}{85}$$

$$19.20. а) \sin(\alpha - \beta) = \sin \alpha \cos \beta - \cos \alpha \sin \beta =$$

$$= -\frac{4}{5} \cdot \frac{15}{17} + \sqrt{1 - \sin^2 \alpha} \sqrt{1 - \cos^2 \beta} = \frac{3}{5} \cdot \frac{8}{17} - \frac{4 \cdot 15}{5 \cdot 17} = -\frac{36}{85}$$

$$б) \cos(\alpha - \beta) = \cos \alpha \cos \beta + \sin \alpha \sin \beta =$$

$$= \frac{15}{17} \sqrt{1 - \sin^2 \alpha} + \frac{4}{5} \sqrt{1 - \cos^2 \beta} = \frac{5}{17} \cdot \frac{3}{5} + \frac{4}{5} \cdot \frac{8}{17} = \frac{77}{85}$$

19.21. а) Опечатка в условии:

$$\sin 77^\circ \cos 17^\circ - \sin 13^\circ \cos 73^\circ = \sin 77^\circ \cos 17^\circ - \cos 77^\circ \sin 17^\circ =$$

$$\sin(77^\circ - 17^\circ) = \sin 60^\circ = \frac{\sqrt{3}}{2};$$

$$б) \cos 125^\circ \cos 5^\circ + \sin 55^\circ \cos 85^\circ = -\cos 55^\circ \cos 5^\circ + \sin 55^\circ \cos 5^\circ =$$

$$= -\cos 60^\circ = -\frac{1}{2}.$$

$$19.22. а) \frac{\cos 105^\circ \cdot \cos 5^\circ + \sin 105^\circ \cdot \cos 85^\circ}{\sin 95^\circ \cdot \cos 5^\circ - \sin 95^\circ \cdot \sin 185^\circ} =$$

$$= \frac{\cos 105^\circ \cdot \cos 5^\circ + \sin 105^\circ \cdot \sin 5^\circ}{\sin 95^\circ \cdot \cos 5^\circ + \cos 95^\circ \cdot \sin 5^\circ} = \frac{\cos 100^\circ}{\sin 100^\circ} = -\operatorname{tg} 70^\circ$$

$$6) \frac{\sin 75^\circ \cdot \cos 5^\circ - \cos 75^\circ \cdot \cos 85^\circ}{\cos 375^\circ \cdot \cos 5^\circ - \sin 15^\circ \cdot \sin 365^\circ} =$$

$$= \frac{\sin 75^\circ \cdot \cos 5^\circ - \cos 75^\circ \cdot \sin 5^\circ}{\cos 15^\circ \cdot \cos 5^\circ - \sin 15^\circ \cdot \sin 5^\circ} = \frac{\sin 70^\circ}{\cos 20^\circ} = \frac{\cos 20^\circ}{\cos 20^\circ} = 1$$

$$19.23. \text{ a) } \sqrt{2} \cos\left(\frac{\pi}{4} - x\right) - \cos x = \frac{1}{2}.$$

$$\cos x + \sin x - \cos x = \frac{1}{2},$$

$$\sin x = \frac{1}{2}, \quad x = (-1)^k \frac{\pi}{6} + \pi k;$$

$$6) \sqrt{2} \sin\left(\frac{\pi}{4} - \frac{x}{2}\right) + \sin \frac{x}{2} = \frac{\sqrt{3}}{2},$$

$$\cos \frac{x}{2} - \sin \frac{x}{2} + \sin \frac{x}{2} = \frac{\sqrt{3}}{2},$$

$$\cos \frac{x}{2} = \frac{\sqrt{3}}{2}, \quad \frac{x}{2} = \pm \frac{\pi}{6} + 2\pi n, \quad x = \pm \frac{\pi}{3} + 4\pi n.$$

$$19.24. \text{ a) } \frac{\sqrt{2}}{2} \sin x - \frac{\sqrt{2}}{2} \cos x = 1,$$

$$\sin\left(x - \frac{\pi}{4}\right) = 1,$$

$$x - \frac{\pi}{4} = \frac{\pi}{2} + 2\pi n, \quad x = \frac{3\pi}{4} + 2\pi n;$$

$$6) \sin x - \cos x = 1,$$

$$\sin\left(x - \frac{\pi}{4}\right) = \frac{\sqrt{2}}{2}, \quad x - \frac{\pi}{4} = (-1)^n \frac{\pi}{4} + \pi n,$$

$$x = (-1)^n \frac{\pi}{4} + \frac{\pi}{4} + \pi n;$$

$$b) \frac{\sqrt{3}}{2} \cos x + \frac{1}{2} \sin x = 1,$$

$$\cos\left(x - \frac{\pi}{6}\right) = 1, \quad x - \frac{\pi}{6} = 2\pi n, \quad x = \frac{\pi}{6} + 2\pi n;$$

$$r) \sqrt{3} \cos x + \sin x = 1,$$

$$\cos\left(x - \frac{\pi}{6}\right) = \frac{1}{2}, \quad x - \frac{\pi}{6} = \pm \frac{\pi}{3} + 2\pi n; \quad x = \pm \frac{\pi}{3} + \frac{\pi}{6} + 2\pi n.$$

$$19.25. \text{ a) } \frac{\sqrt{2}}{2} \sin x + \frac{\sqrt{2}}{2} \cos x = 1,$$

$$\sin \frac{\pi}{4} \sin x + \frac{\sqrt{2}}{2} \cos x = 1,$$

$$\cos \left(x - \frac{\pi}{4}\right) = 1, \quad x - \frac{\pi}{4} = 2\pi n, \quad x = \frac{\pi}{4} + 2\pi n;$$

$$б) \sin x + \cos x = 1,$$

$$\sin \left(x + \frac{\pi}{4}\right) = \frac{1}{\sqrt{2}}, \quad x + \frac{\pi}{4} = (-1)^k \frac{\pi}{4} + \pi n,$$

$$x = (-1)^k \frac{\pi}{4} - \frac{\pi}{4} + \pi n;$$

$$в) \frac{\sqrt{3}}{2} \cos x - \frac{1}{2} \sin x = 1,$$

$$\cos \frac{\pi}{6} \cos x - \sin \frac{\pi}{6} \sin x = 1, \quad \cos \left(x + \frac{\pi}{6}\right) = 1,$$

$$x + \frac{\pi}{6} = 2\pi n, \quad x = -\frac{\pi}{6} + 2\pi n;$$

$$г) \sqrt{3} \cos x - \sin x = 1,$$

$$\frac{\sqrt{3}}{2} \cos x - \frac{1}{2} \sin x = \frac{1}{2}, \quad \cos \left(x + \frac{\pi}{6}\right) = \frac{1}{2},$$

$$x + \frac{\pi}{6} = \pm \frac{\pi}{3} + 2\pi n, \quad x = \pm \frac{\pi}{3} - \frac{\pi}{6} + 2\pi n.$$

$$19.26. а) \sin x \cos 3x + \cos x \sin 3x > \frac{1}{2}, \quad \sin 4x > \frac{1}{2},$$

$$4x \in \left(\frac{\pi}{6} + 2\pi n; \frac{5\pi}{6} + 2\pi n\right), \quad x \in \left(\frac{\pi}{24} + \frac{\pi n}{2}; \frac{5\pi}{24} + \frac{\pi n}{2}\right);$$

$$б) \cos 2x \cos 5x - \sin 2x \sin 5x < -\frac{1}{3}, \quad \cos 7x < -\frac{1}{3},$$

$$7x \in \left(\pi - \arccos \frac{1}{3} + 2\pi n; \pi + \arccos \frac{1}{3} + 2\pi n\right),$$

$$x \in \left(\frac{\pi}{7} - \frac{1}{7} \arccos \frac{1}{3} + \frac{2\pi n}{7}; \frac{\pi}{7} + \frac{1}{7} \arccos \frac{1}{3} + \frac{2\pi n}{7}\right);$$

$$в) \sin \frac{x}{4} \cos \frac{x}{2} - \cos \frac{x}{4} \sin \frac{x}{2} < \frac{1}{3},$$

$$\sin \left(\frac{x}{4} - \frac{x}{2}\right) < \frac{1}{3}, \quad \sin \frac{x}{4} > -\frac{1}{3},$$

$$\frac{x}{4} \in \left(-\arcsin \frac{1}{3} + 2\pi n; \pi + \arcsin \frac{1}{3} + 2\pi n\right),$$

$$x \in \left(-4 \arcsin \frac{1}{3} + 8\pi n; 4\pi + 4 \arcsin \frac{1}{3} + 8\pi n\right);$$

$$r) \sin 2x \sin 5x + \cos 2x \cos 5x > -\frac{\sqrt{3}}{2},$$

$$\cos 3x > -\frac{\sqrt{3}}{2},$$

$$3x \in \left(-\frac{5\pi}{6} + 2\pi n; \frac{5\pi}{6} + 2\pi n\right),$$

$$x \in \left(-\frac{5\pi}{18} + \frac{2\pi n}{3}; \frac{5\pi}{18} + \frac{2\pi n}{3}\right).$$

§ 20. Тангенс суммы и разности аргументов

$$20.1. a) \operatorname{tg} \frac{\pi}{12} = \operatorname{tg} (45^\circ - 30^\circ) = \frac{\operatorname{tg} 45^\circ - \operatorname{tg} 30^\circ}{1 + \operatorname{tg} 45^\circ \operatorname{tg} 30^\circ} = \frac{1 - \frac{\sqrt{3}}{3}}{1 + \frac{\sqrt{3}}{3}}.$$

$$б) \operatorname{tg} 105^\circ = \operatorname{tg} (60^\circ + 45^\circ) = \frac{\operatorname{tg} 60^\circ + \operatorname{tg} 45^\circ}{1 - \operatorname{tg} 60^\circ \operatorname{tg} 45^\circ} = \frac{\sqrt{3} + 1}{1 - \sqrt{3}}.$$

$$в) \operatorname{tg} \frac{5\pi}{12} = \operatorname{tg} (45^\circ + 30^\circ) = \frac{\operatorname{tg} 45^\circ + \operatorname{tg} 30^\circ}{1 - \operatorname{tg} 45^\circ \operatorname{tg} 30^\circ} = \frac{1 + \frac{\sqrt{3}}{3}}{1 - \frac{\sqrt{3}}{3}}.$$

$$r) \operatorname{tg} 165^\circ = -\operatorname{tg} 15^\circ = -\frac{1 - \frac{\sqrt{3}}{3}}{1 + \frac{\sqrt{3}}{3}}.$$

$$20.2. a) \frac{\operatorname{tg} 25^\circ + \operatorname{tg} 20^\circ}{1 - \operatorname{tg} 25^\circ \operatorname{tg} 20^\circ} = \operatorname{tg} 45^\circ = 1; \quad б) \frac{1 - \operatorname{tg} 70^\circ \operatorname{tg} 65^\circ}{\operatorname{tg} 70^\circ + \operatorname{tg} 65^\circ} = \operatorname{ctg} 135^\circ = -1;$$

$$в) \frac{\operatorname{tg} 9^\circ + \operatorname{tg} 51^\circ}{1 - \operatorname{tg} 9^\circ \operatorname{tg} 51^\circ} = \operatorname{tg} 60^\circ = \sqrt{3}; \quad r) \frac{1 + \operatorname{tg} 54^\circ \operatorname{tg} 9^\circ}{\operatorname{tg} 54^\circ - \operatorname{tg} 9^\circ} = \operatorname{ctg} 45^\circ = 1.$$

$$20.3. a) \operatorname{tg} \left(\frac{\pi}{4} - \alpha\right), \operatorname{tg} \alpha = \frac{2}{3}, \operatorname{tg} \left(\frac{\pi}{4} - \alpha\right) = \frac{1 - \operatorname{tg} \alpha}{1 + \operatorname{tg} \alpha} = \frac{1 - \frac{2}{3}}{1 + \frac{2}{3}} = \frac{1}{5};$$

$$б) \operatorname{tg} \alpha = \frac{4}{5},$$

$$\operatorname{tg} \left(\alpha + \frac{\pi}{3}\right) = \frac{\operatorname{tg} \alpha + \operatorname{tg} \frac{\pi}{3}}{1 - \operatorname{tg} \alpha \operatorname{tg} \frac{\pi}{3}} = \frac{\frac{4}{5} + \sqrt{3}}{1 - \frac{4}{5} \cdot \sqrt{3}} = \frac{4 + 5\sqrt{3}}{5 - 4\sqrt{3}} = \frac{41\sqrt{3} + 80}{23};$$

$$b) \operatorname{ctg} \alpha = \frac{4}{3}, \quad \operatorname{tg} \left(\frac{\pi}{2} + \alpha \right) = -\operatorname{ctg} \alpha = -\frac{4}{3};$$

$$r) \operatorname{ctg} \alpha = \frac{8}{5}, \quad \operatorname{tg} \left(\alpha - \frac{\pi}{4} \right) = \frac{\operatorname{tg} \alpha - 1}{1 + \operatorname{tg} \alpha} = \frac{\frac{5}{8} - 1}{1 + \frac{5}{8}} = -\frac{3}{13}.$$

$$20.4. \operatorname{tg} \alpha = \frac{1}{2}, \quad \operatorname{tg} \beta = \frac{1}{3};$$

$$a) \operatorname{tg} (\alpha + \beta) = \frac{\operatorname{tg} \alpha + \operatorname{tg} \beta}{1 - \operatorname{tg} \alpha \operatorname{tg} \beta} = \frac{\frac{1}{2} + \frac{1}{3}}{1 - \frac{1}{6}} = \frac{5}{6} \cdot \frac{6}{5} = 1.$$

$$b) \operatorname{tg} (\alpha - \beta) = \frac{\frac{1}{2} - \frac{1}{3}}{1 + \frac{1}{6}} = \frac{1}{6} \cdot \frac{6}{7} = \frac{1}{7}.$$

$$20.5. \operatorname{tg} \alpha = \frac{2}{5}, \quad \operatorname{tg} \left(\frac{\pi}{2} + \beta \right) = -3, \quad -\operatorname{ctg} \beta = -3, \quad \operatorname{tg} \beta = \frac{1}{3};$$

$$a) \operatorname{tg} (\alpha + \beta) = \frac{\operatorname{tg} \alpha + \operatorname{tg} \beta}{1 - \operatorname{tg} \alpha \operatorname{tg} \beta} = \frac{\frac{2}{5} + \frac{1}{3}}{1 - \frac{2}{15}} = \frac{11}{15} \cdot \frac{15}{13} = \frac{11}{13};$$

$$b) \operatorname{tg} (\alpha - \beta) = \frac{\operatorname{tg} \alpha - \operatorname{tg} \beta}{1 + \operatorname{tg} \alpha \operatorname{tg} \beta} = \frac{\frac{2}{5} - \frac{1}{3}}{1 + \frac{2}{15}} = \frac{11}{15} \cdot \frac{15}{17} = \frac{1}{17}.$$

$$20.6. a) \frac{\operatorname{tg} 2,22 + \operatorname{tg} 0,92}{1 - \operatorname{tg} 2,22 \cdot \operatorname{tg} 0,92} = \operatorname{tg} (2,22 + 0,92) = \operatorname{tg} 3,14.$$

$$b) \frac{\operatorname{tg} 1,47 - \operatorname{tg} 0,69}{1 + \operatorname{tg} 1,47 \operatorname{tg} 0,69} = \operatorname{tg} (1,47 - 0,69) = \operatorname{tg} 0,78.$$

$$20.7. a) \frac{\operatorname{tg} \left(\frac{\pi}{8} + \alpha \right) + \operatorname{tg} \left(\frac{\pi}{8} - \alpha \right)}{1 - \operatorname{tg} \left(\frac{\pi}{8} + \alpha \right) \operatorname{tg} \left(\frac{\pi}{8} - \alpha \right)} = \operatorname{tg} \left(\frac{\pi}{8} + \alpha + \frac{\pi}{8} - \alpha \right) =$$

$$\operatorname{tg} \frac{\pi}{4} = 1.$$

$$b) \frac{\operatorname{tg} (45^\circ + \alpha) - \operatorname{tg} \alpha}{1 + \operatorname{tg} (45^\circ + \alpha) \operatorname{tg} \alpha} = \operatorname{tg} (45^\circ + \alpha - \alpha) = \operatorname{tg} 45^\circ = 1.$$

$$20.8. a) \frac{1 - \operatorname{tg} \alpha}{1 + \operatorname{tg} \alpha} = \operatorname{tg} (45^\circ - \alpha), \quad \operatorname{tg} (45^\circ - \alpha) = \frac{1 - \operatorname{tg} \alpha}{1 + \operatorname{tg} \alpha}.$$

$$b) \frac{\operatorname{tg} \alpha + \operatorname{tg} \beta}{\operatorname{tg}(\alpha + \beta)} + \frac{\operatorname{tg} \alpha - \operatorname{tg} \beta}{\operatorname{tg}(\alpha - \beta)} = 2.$$

$$\frac{\operatorname{tg} \alpha + \operatorname{tg} \beta}{\operatorname{tg}(\alpha + \beta)} + \frac{\operatorname{tg} \alpha - \operatorname{tg} \beta}{\operatorname{tg}(\alpha - \beta)} = 1 - \operatorname{tg} \alpha \operatorname{tg} \beta + 1 + \operatorname{tg} \alpha \operatorname{tg} \beta = 2.$$

$$20.9. a) \frac{\operatorname{tg} x + \operatorname{tg} 3x}{1 - \operatorname{tg} x \operatorname{tg} 3x} = 1,$$

$$\operatorname{tg} 4x = 1, \quad 4x = \frac{\pi}{4} + \pi n, \quad x = \frac{\pi}{16} + \frac{\pi}{4} n;$$

$$b) \frac{\operatorname{tg} 5x - \operatorname{tg} 3x}{1 + \operatorname{tg} 3x \operatorname{tg} 5x} = \sqrt{3},$$

$$\operatorname{tg} 2x = \sqrt{3}, \quad 2x = \frac{\pi}{3} + \pi n, \quad x = \frac{\pi}{6} + \frac{\pi n}{2}.$$

$$20.10. a) \frac{\sqrt{3} - \operatorname{tg} x}{1 + \sqrt{3} \operatorname{tg} x} = 1,$$

$$\operatorname{tg} \left(\frac{\pi}{3} - x \right) = 1, \quad x - \frac{\pi}{3} = -\frac{\pi}{4} + \pi n, \quad x = \frac{\pi}{12} + \pi n,$$

$$x \in [-\pi, 2\pi] \quad x = -\frac{11\pi}{12}, \frac{\pi}{12}, \frac{13\pi}{12};$$

$$b) \frac{\operatorname{tg} \frac{\pi}{5} - \operatorname{tg} 2x}{\operatorname{tg} \frac{\pi}{5} \operatorname{tg} 2x + 1} = \sqrt{3}, \quad \operatorname{tg} \left(2x - \frac{\pi}{5} \right) = -\sqrt{3},$$

$$2x - \frac{\pi}{5} = -\frac{\pi}{3} + \pi n, \quad x = -\frac{\pi}{15} + \frac{\pi n}{2}, \quad x \in [-\pi, 2\pi]$$

$$x = -\frac{17\pi}{30}, -\frac{\pi}{15}, \frac{13\pi}{30}, \frac{14\pi}{15}, \frac{43\pi}{30}, \frac{29\pi}{15}.$$

$$20.11. a) \operatorname{tg} \left(\alpha - \frac{\pi}{4} \right) = 3, \quad \frac{\operatorname{tg} \alpha - 1}{1 + \operatorname{tg} \alpha} = 3, \quad \operatorname{tg} \alpha - 1 = 3 + 3 \operatorname{tg} \alpha,$$

$$2 \operatorname{tg} \alpha = -4, \quad \operatorname{tg} \alpha = -2;$$

$$b) \operatorname{tg} \left(\alpha + \frac{\pi}{4} \right) = \frac{1}{5}, \quad \frac{\operatorname{tg} \alpha + 1}{1 - \operatorname{tg} \alpha} = \frac{1}{5},$$

$$5 \operatorname{tg} \alpha + 5 = 1 - \operatorname{tg} \alpha, \quad \operatorname{tg} \alpha = -\frac{2}{3},$$

$$\operatorname{ctg} \alpha = -\frac{3}{2}.$$

$$20.12. \text{ a) } \operatorname{tg} \alpha = 3, \quad \operatorname{tg}(\alpha + \beta) = 1.$$

$$\frac{\operatorname{tg} \alpha + \operatorname{tg} \beta}{1 - \operatorname{tg} \alpha \operatorname{tg} \beta} = 1, \quad 3 + \operatorname{tg} \beta = 1 - 3 \operatorname{tg} \beta, \quad \operatorname{tg} \beta = -\frac{1}{2};$$

$$\text{б) } \operatorname{tg} \alpha = \frac{1}{4}, \quad \operatorname{tg}(\alpha - \beta) = 2.$$

$$\frac{\operatorname{tg} \alpha - \operatorname{tg} \beta}{1 + \operatorname{tg} \alpha \operatorname{tg} \beta} = 2, \quad \frac{1}{4} - \operatorname{tg} \beta = 2 + \frac{1}{2} \operatorname{tg} \beta,$$

$$\frac{3}{2} \operatorname{tg} \beta = -\frac{7}{4}, \quad \operatorname{tg} \beta = -\frac{7}{6}.$$

$$20.13. \sin \alpha = -\frac{12}{13}, \quad \pi < \alpha < \frac{3\pi}{2}; \quad \cos \alpha = -\frac{5}{13}, \quad \operatorname{tg} \alpha = \frac{12}{5};$$

$$\text{a) } \operatorname{tg}\left(\alpha + \frac{\pi}{4}\right) = \frac{\operatorname{tg} \alpha + 1}{1 - \operatorname{tg} \alpha} = \frac{\frac{12}{5} + 1}{1 - \frac{12}{5}} = -\frac{17}{5} \cdot \frac{5}{7} = -\frac{17}{7}.$$

$$\text{б) } \operatorname{tg}\left(\alpha - \frac{\pi}{4}\right) = \frac{\operatorname{tg} \alpha - 1}{1 + \operatorname{tg} \alpha} = \frac{\frac{12}{5} - 1}{1 + \frac{12}{5}} = \frac{7}{5} \cdot \frac{5}{17} = \frac{7}{17}.$$

$$20.14. \cos \alpha = \frac{3}{5}, \quad 0 < \alpha < \frac{\pi}{2}, \quad \sin \alpha = \frac{4}{5}, \quad \operatorname{tg} \alpha = \frac{4}{3};$$

$$\text{a) } \operatorname{tg}\left(\alpha + \frac{\pi}{3}\right) = \frac{\operatorname{tg} \alpha + \operatorname{tg} \frac{\pi}{3}}{1 - \operatorname{tg} \alpha \operatorname{tg} \frac{\pi}{3}} = \frac{\frac{4}{3} + \sqrt{3}}{1 - \frac{4}{3}\sqrt{3}} = \frac{4 + 3\sqrt{3}}{3 - 4\sqrt{3}} = -\frac{25\sqrt{3} - 48}{39};$$

$$\text{б) } \operatorname{tg}\left(\alpha - \frac{\pi}{3}\right) = \frac{\operatorname{tg} \alpha - \operatorname{tg} \frac{\pi}{3}}{1 + \operatorname{tg} \alpha \operatorname{tg} \frac{\pi}{3}} = \frac{\frac{4}{3} - \sqrt{3}}{1 + \frac{4}{3}\sqrt{3}} = \frac{4 - 3\sqrt{3}}{3 + 4\sqrt{3}} \cdot \frac{3}{3} = \frac{4 - 3\sqrt{3}}{3 + 4\sqrt{3}}.$$

$$20.15. y_1 = 3x + 1 \quad y_2 = 6 - 2x.$$

$\operatorname{tg} y_1 = 3$ – тангенс угла наклона 1-й прямой.

$\operatorname{tg} y_2 = -2$ – тангенс угла наклона 2-ой прямой.

$$y_1 = \operatorname{arctg} 3, \quad y_2 = -\operatorname{arctg} 2$$

$$y_1 - y_2 = \operatorname{arctg} 3 + \operatorname{arctg} 2$$

$$\operatorname{tg}(y_1 - y_2) = \frac{3 + 2}{1 - 6} = -1.$$

$$y_1 - y_2 = \frac{3\pi}{4}.$$

$$20.16. \operatorname{tg} \angle KBC = \frac{1}{2}, \quad \angle KBC = \operatorname{arctg} \frac{1}{2}. \quad (\text{см. рис. 144})$$

$$\angle BKC = 90^\circ - \angle KBC$$

$$\angle KOC = 180^\circ - 45^\circ - 90^\circ + \angle KBC = 45^\circ + \angle KBC.$$

$$\operatorname{tg} \angle KOC = \operatorname{tg} \left(45^\circ + \operatorname{arctg} \frac{1}{2} \right) = \frac{1 + \frac{1}{2}}{1 - \frac{1}{2}} = \frac{3}{2} \cdot 2 = 3$$

$$\angle KOC = \operatorname{arctg} 3.$$

§ 21. Формулы двойного угла

$$21.1. \text{ а) } \frac{\sin 2t}{\cos t} - \sin t = 2 \sin t - \sin t = \sin t.$$

$$\text{б) } \frac{\sin 6t}{\cos^2 3t} = 2 \operatorname{tg} 3t.$$

$$\text{в) } \cos^2 t - \cos 2t = \cos^2 t - \cos^2 t + \sin^2 t = \sin^2 t.$$

$$\text{г) } \frac{\cos 2t}{\cos t - \sin t} - \sin t = \frac{(\cos - \sin t)(\cos t + \sin t)}{\cos t - \sin t} - \sin t = \cos t.$$

$$21.2. \text{ а) } \frac{\sin 40^\circ}{\sin 20^\circ} = 2 \cos 20^\circ; \quad \text{б) } \frac{\cos 80^\circ}{\cos 40^\circ + \sin 40^\circ} = \cos 40^\circ - \sin 40^\circ;$$

$$\text{в) } \frac{\sin 100^\circ}{2 \cos 50^\circ} = \sin 50^\circ; \quad \text{г) } \frac{\cos 36^\circ + \sin^2 18^\circ}{\cos 18^\circ} = \frac{\cos^2 18^\circ}{\cos 18^\circ} = \cos 18^\circ.$$

$$21.3. \text{ а) } 2 \sin 15^\circ \cos 15^\circ = \sin 30^\circ = \frac{1}{2}.$$

$$\text{б) } (\cos 75^\circ - \sin 75^\circ)^2 = 1 - 2 \sin 75^\circ \cos 75^\circ = 1 - \sin 150^\circ = \frac{1}{2}.$$

$$\text{в) } \cos^2 15^\circ - \sin^2 15^\circ = \cos 30^\circ = \frac{\sqrt{3}}{2}.$$

$$\text{г) } (\cos 15^\circ + \sin 15^\circ)^2 = 1 + 2 \sin 15^\circ \cos 15^\circ = \frac{3}{2}.$$

21.4.

$$\text{а) } 2 \sin \frac{\pi}{8} \cos \frac{\pi}{8} = \sin \frac{\pi}{4} = \frac{\sqrt{2}}{2}.$$

$$\text{б) } \sin \frac{\pi}{8} \cos \frac{\pi}{8} + \frac{1}{4} = \frac{\sqrt{2}}{4} + \frac{1}{4} = \frac{\sqrt{2} + 1}{4}.$$

$$\text{в) } \cos^2 \frac{\pi}{8} - \sin^2 \frac{\pi}{8} = \cos \frac{\pi}{4} = \frac{\sqrt{2}}{2}.$$

$$\text{г) } \frac{\sqrt{2}}{2} - (\cos \frac{\pi}{8} + \sin \frac{\pi}{8})^2 = \frac{\sqrt{2}}{2} - 1 - \sin \frac{\pi}{4} = -1.$$

$$21.5. \text{ a) } \frac{\operatorname{tg} \frac{\pi}{8}}{1 - \operatorname{tg}^2 \frac{\pi}{8}} = \frac{1}{2} \operatorname{tg} \frac{\pi}{4} = \frac{1}{2};$$

$$\text{б) } \frac{\operatorname{tg} 75^\circ}{1 - \operatorname{tg}^2 75^\circ} = \frac{1}{2} \operatorname{tg} 150^\circ = -\frac{1}{2} \operatorname{tg} 30^\circ = -\frac{\sqrt{3}}{6};$$

$$21.6. \text{ a) } \sin \frac{x}{2} \cos \frac{x}{2} = \frac{1}{2} \sin x, \quad \frac{1}{2} \sin x = \sin \frac{x}{2} \cos \frac{x}{2}.$$

$$\text{б) } \cos^2 \frac{x}{4} - \sin^2 \frac{x}{4} = \cos \frac{x}{2}, \quad \cos \frac{x}{2} = \cos^2 \frac{x}{4} - \sin^2 \frac{x}{4}.$$

$$\text{в) } \sin 2x \cos 2x = \frac{1}{2} \sin 4x, \quad \frac{1}{2} \sin 4x = \sin 2x \cos 2x.$$

$$\text{г) } \cos^2 \frac{x}{2} - \sin^2 \frac{x}{2} = \cos x, \quad \cos x = \cos^2 \frac{x}{2} - \sin^2 \frac{x}{2}.$$

$$21.7. \text{ a) } \cos (2\alpha + 2\beta) = \cos^2 (\alpha + \beta) - \sin^2 (\alpha + \beta). \\ \cos (2\alpha + 2\beta) = \cos 2(\alpha + \beta) = \cos^2 (\alpha + \beta) - \sin^2 (\alpha + \beta).$$

$$\text{б) } \sin (2\alpha + 2\beta) = 2 \sin (\alpha + \beta) \cos (\alpha + \beta).$$

$$\sin (2\alpha + 2\beta) = \sin 2(\alpha + \beta) = 2 \sin (\alpha + \beta) \cos (\alpha + \beta).$$

$$21.8. \text{ a) } \operatorname{tg} (2\alpha + 2\beta) = \frac{2\operatorname{tg}(\alpha + \beta)}{1 - \operatorname{tg}^2(\alpha + \beta)}$$

$$\operatorname{tg} (2\alpha + 2\beta) = \operatorname{tg} 2(\alpha + \beta) = \frac{2\operatorname{tg}(\alpha + \beta)}{1 - \operatorname{tg}^2(\alpha + \beta)}.$$

$$\text{б) } \operatorname{tg} (\alpha + \beta) = \frac{2\operatorname{tg}(\frac{\alpha}{2} + \frac{\beta}{2})}{1 - \operatorname{tg}^2(\frac{\alpha}{2} + \frac{\beta}{2})} \quad \operatorname{tg} (\alpha + \beta) = \operatorname{tg} 2(\frac{\alpha}{2} + \frac{\beta}{2}) =$$

$$= \frac{2\operatorname{tg}(\frac{\alpha}{2} + \frac{\beta}{2})}{1 - \operatorname{tg}^2(\frac{\alpha}{2} + \frac{\beta}{2})}.$$

$$21.9. \sin t = \frac{5}{13}, \quad \frac{\pi}{2} < t < \pi;$$

$$\cos t = -\frac{12}{13}; \quad \operatorname{tg} t = \frac{5}{13} \cdot \left(-\frac{13}{12}\right) = -\frac{5}{12};$$

$$\text{a) } \sin 2t = 2 \sin t \cos t = 2 \cdot \frac{5}{13} \cdot \left(-\frac{12}{13}\right) = -\frac{120}{169}.$$

$$\text{б) } \cos 2t = \cos^2 t - \sin^2 t = \frac{144}{169} - \frac{25}{169} = \frac{119}{169}.$$

$$\text{b) } \operatorname{tg} 2t = \frac{2 \operatorname{tg} t}{1 - \operatorname{tg}^2 t} = \frac{2 \cdot \left(-\frac{5}{12}\right)}{1 - \frac{25}{144}} = -\frac{5}{6} \cdot \frac{144}{119} = -\frac{120}{119}.$$

$$\text{r) } \operatorname{ctg} 2t = \frac{1}{\operatorname{tg} 2t} = -\frac{119}{120}.$$

$$21.10. \cos x = \frac{4}{5}, \quad 0 < x < \frac{\pi}{2}; \quad \sin x = \frac{3}{5}, \quad \operatorname{tg} x = \frac{3}{4}, \quad \operatorname{ctg} x = \frac{4}{3};$$

$$\text{a) } \sin 2x = 2 \cdot \frac{4}{5} \cdot \frac{3}{5} = \frac{24}{25}; \quad \text{b) } \cos 2x = \frac{16}{25} - \frac{9}{25} = \frac{7}{25}.$$

$$\text{b) } \operatorname{tg} 2x = \frac{2 \operatorname{tg} x}{1 - \operatorname{tg}^2 x} = \frac{2 \cdot \frac{3}{4}}{1 - \frac{9}{16}} = \frac{3}{2} \cdot \frac{16}{7} = \frac{24}{7}; \quad \text{r) } \operatorname{ctg} 2x = \frac{7}{24}.$$

$$21.11. \text{ a) } \cos t = \frac{3}{4}, \quad 0 < t < \frac{\pi}{2};$$

$$\cos \frac{t}{2} = \sqrt{\frac{\cos t + 1}{2}} = \frac{\sqrt{14}}{4};$$

$$\sin \frac{t}{2} = \sqrt{\frac{1 - \cos t}{2}} = \frac{\sqrt{2}}{4};$$

$$\operatorname{tg} \frac{t}{2} = \frac{\sin \frac{t}{2}}{\cos \frac{t}{2}} = \frac{\sqrt{2}}{\sqrt{14}} = \frac{\sqrt{7}}{7}; \quad \operatorname{ctg} \frac{t}{2} = \frac{\cos \frac{t}{2}}{\sin \frac{t}{2}} = \sqrt{7}$$

$$\text{b) } \operatorname{ctg} t = \frac{3}{4}, \quad \pi < t < \frac{3\pi}{2};$$

$$\cos t = -\frac{\operatorname{ctg} t}{\sqrt{1 + \operatorname{ctg}^2 t}} = -\frac{3}{5}; \quad \cos \frac{t}{2} = -\sqrt{\frac{\cos t + 1}{2}} = -\frac{1}{\sqrt{5}}$$

$$\sin \frac{t}{2} = \sqrt{\frac{1 - \cos t}{2}} = \frac{2}{\sqrt{5}}; \quad \operatorname{tg} \frac{t}{2} = \frac{\sin \frac{t}{2}}{\cos \frac{t}{2}} = -2; \quad \operatorname{ctg} \frac{t}{2} = \frac{\cos \frac{t}{2}}{\sin \frac{t}{2}} = -\frac{1}{2}$$

$$21.12. \text{ a) } \sin 2x = -\frac{3}{5}, \quad \frac{\pi}{2} < x < \frac{3\pi}{4}$$

$$\cos 2x = -\sqrt{1 - \sin^2 2x} = -\frac{4}{5}; \quad \cos x = -\sqrt{\frac{\cos 2x + 1}{2}} = -\frac{1}{\sqrt{10}};$$

$$\sin x = \sqrt{\frac{1 - \cos 2x}{2}} = \frac{3}{\sqrt{10}}; \quad \operatorname{tg} x = \frac{\sin x}{\cos x} = -3 \quad \operatorname{ctg} x = \frac{\cos x}{\sin x} = -\frac{1}{3}$$

$$6) \operatorname{tg} 2x = \frac{3}{4}, \quad \pi < x < \frac{5\pi}{4}$$

$$\cos 2x = \frac{1}{\sqrt{1 + \operatorname{tg}^2 2x}} = \frac{4}{5}; \quad \cos x = -\sqrt{\frac{\cos 2x + 1}{2}} = -\frac{3}{\sqrt{10}};$$

$$\sin x = -\sqrt{\frac{1 - \cos 2x}{2}} = -\frac{1}{\sqrt{10}}; \quad \operatorname{tg} x = \frac{\sin x}{\cos x} = \frac{1}{3}, \quad \operatorname{ctg} x = \frac{\cos x}{\sin x} = 3$$

$$21.13. \text{ a) } \frac{\sin t}{2 \cos^2 \frac{t}{2}} = \frac{2 \sin \frac{t}{2} (\cos \frac{t}{2})}{2 \cos^2 \frac{t}{2}} = \operatorname{tg} \frac{t}{2}.$$

$$6) \frac{\cos t}{\cos \frac{t}{2} + \sin \frac{t}{2}} = \frac{\cos^2 \frac{t}{2} - \sin^2 \frac{t}{2}}{\cos \frac{t}{2} + \sin \frac{t}{2}} = \cos \frac{t}{2} - \sin \frac{t}{2}.$$

$$b) \frac{\sin 4t}{\cos 2t} = \frac{2 \sin 2t \cos 2t}{\cos 2t} = 2 \sin 2t.$$

$$r) \frac{\cos 2t - \sin 2t}{\cos 4t} = \frac{\cos 2t - \sin 2t}{(\sin 2t - \sin 2t)(\cos 2t + \cos 2t)} =$$

$$= \frac{1}{\cos 2t + \sin 2t}.$$

$$21.14. \text{ a) } \frac{\sin 2t - 2 \sin t}{\cos t - 1} = \frac{2 \sin t (\cos t - 1)}{\cos t - 1} = 2 \sin t.$$

$$6) \frac{\cos 2t - \cos^2 t}{1 - \cos^2 t} = \frac{\cos^2 t - \sin^2 t - \cos^2 t}{\sin^2 t} = -1$$

$$b) \sin 2t \operatorname{ctg} t - 1 = 2 \sin t \cos t \cdot \frac{\cos t}{\sin t} - 1 = 2 \cos^2 t - 1 = \cos 2t.$$

$$r) (\operatorname{tg} t + \operatorname{ctg} t) \sin 2t = \frac{1}{\sin t \cos t} \cdot 2 \sin t \cos t = 2.$$

$$21.15. \text{ a) } \frac{2}{\operatorname{tg} t + \operatorname{ctg} t} = \frac{2}{\frac{1}{\sin t \cos t}} = \sin 2t.$$

$$6) \frac{2}{\operatorname{tg} t - \operatorname{ctg} t} = \frac{2}{\frac{-\cos 2t}{\sin t \cos t}} = \frac{\sin 2t}{-\cos 2t} = -\operatorname{tg} 2t.$$

$$21.16. \text{ a) } (1 - \operatorname{tg}^2 t) \cos^2 t = \cos^2 t - \sin^2 t = \cos 2t.$$

$$6) 2 \cos^2 \frac{\pi + t}{4} - 2 \sin^2 \frac{\pi + t}{4} = 2 \cos \left(\frac{\pi}{2} + \frac{t}{2} \right) = -2 \sin \frac{t}{2}.$$

$$21.17. \text{ a) } (\sin t - \cos t)^2 = 1 - \sin 2t, \quad \sin^2 t - 2 \sin t \cos t + \cos^2 t = \\ = 1 - \sin 2t.$$

$$\text{б) } 2 \cos^2 t = 1 + \cos 2t, \quad 1 + \cos 2t = \sin^2 t + \cos^2 t - \sin^2 t + \cos^2 t = \\ = 2 \cos^2 t.$$

$$\text{в) } (\sin t + \cos t)^2 = 1 + \sin 2t, \quad \sin^2 t + \cos^2 t + 2 \sin t \cos t = 1 + \sin 2t.$$

$$\text{г) } 2 \sin^2 t = 1 - \cos 2t, \quad 1 - \cos 2t = \sin^2 t + \cos^2 t - \cos^2 t + \sin^2 t = \\ = 2 \sin^2 t.$$

$$21.18. \text{ a) } \cos 4t - \sin 4t = \cos 2t.$$

$$\cos 2t = (\cos^2 t - \sin^2 t) \cdot 1 = (\cos^2 t - \sin^2 t) (\cos^2 t + \sin^2 t) = \cos^4 t - \sin^4 t.$$

$$\text{б) } \cos^4 t + \sin^4 t = 1 - \frac{1}{2} \cdot \sin^2 2t.$$

$$\cos^4 t + \sin^4 t + 2 \sin^2 t \cos^2 t - 2 \sin^2 t \cos^2 t = (\sin^2 t + \cos^2 t)^2 - \frac{1}{2} \sin^2 2t = \\ = 1 - \frac{1}{2} \sin^2 2t.$$

$$21.19. \text{ a) } \operatorname{ctg} t - \sin 2t = \operatorname{ctg} t \cos 2t.$$

$$\frac{\cos t - 2 \sin^2 t \cos t}{\sin t} = \frac{\cos t (\cos^2 t - \sin^2 t)}{\sin t} = \frac{\cos t \cdot \cos 2t}{\sin t} = \operatorname{ctg} t \cos 2t$$

$$\text{б) } \sin 2t - \operatorname{tg} t = \cos 2t \operatorname{tg} t;$$

$$\frac{2 \sin t \cos^2 t - \sin t}{\cos t} = \frac{(\cos^2 t - \sin^2 t) \sin t}{\cos t} = \frac{\cos 2t \sin t}{\cos t} = \cos 2t \operatorname{tg} t$$

$$21.20. \text{ a) } \sin^2 2t = \frac{1 - \cos 4t}{2}; \quad \frac{1 - \cos 4t}{2} = \frac{1}{2} (1 - \cos^2 2t + \sin^2 2t) =$$

$$= \frac{1}{2} (2 \sin^2 2t) = \sin^2 2t$$

$$\text{б) } 2 \sin^2 \frac{t}{2} + \cos t = 1. \quad 2(1 - \cos t) \cdot \frac{1}{2} + \cos t = 1.$$

$$\text{в) } 2 \sin^2 2t = 1 + \sin \left(\frac{3\pi}{2} - 4t \right). \quad 1 - \cos 4t = 1 + \sin \left(\frac{3\pi}{2} - 4t \right).$$

$$\text{г) } 2 \cos^2 t - \cos 2t = 1. \quad 2 \cos^2 t - \cos 2t = 2 \cos^2 t - \cos^2 t + \sin^2 t = 1.$$

$$21.21. \text{ a) } \cos^2 3t = \frac{1 + \sin \left(\frac{\pi}{2} - 6t \right)}{2}, \quad \cos^2 3t = \frac{1 + \cos 6t}{2} = \frac{1 + \sin \left(\frac{\pi}{2} - 6t \right)}{2}.$$

$$\text{б) } \frac{1 - \cos t}{1 + \cos t} = \operatorname{tg}^2 \frac{t}{2}; \quad \operatorname{tg}^2 \frac{t}{2} = \frac{\sin^2 \frac{t}{2}}{\cos^2 \frac{t}{2}} = \frac{1 - \cos t}{1 + \cos t}.$$

$$\text{в) } \cos^2 3t = \frac{1 - \cos(6t - 3\pi)}{2} = \cos^2 3t = \frac{1 + \cos 6t}{2} = \frac{1 - \cos(6t - 3\pi)}{2}$$

$$r) \frac{1 - \cos t}{\sin t} = \operatorname{tg} \frac{t}{2}, \quad \frac{1 - \cos t}{2} = \frac{2 \sin^2 \frac{t}{2}}{2 \sin \frac{t}{2} \cos \frac{t}{2}} = \operatorname{tg} \frac{t}{2}.$$

$$21.22. a) 1 + \sin \alpha = 2 \cos^2 \left(45^\circ - \frac{\alpha}{2}\right),$$

$$2 \cos^2 \left(45^\circ - \frac{\alpha}{2}\right) = 1 + \cos (90^\circ - \alpha) = 1 + \sin \alpha.$$

$$b) 2 \sin^2 (45^\circ - \alpha) + \sin 2\alpha = 1,$$

$$1 - \cos (90^\circ - 2\alpha) + \sin 2\alpha = 1 - \sin 2\alpha + \sin 2\alpha = 1;$$

$$b) 1 - \sin \alpha = 2 \sin^2 \left(45^\circ - \frac{\alpha}{2}\right),$$

$$2 \sin^2 \left(45^\circ - \frac{\alpha}{2}\right) = 1 - \cos (90^\circ - \alpha) = 1 - \sin \alpha;$$

$$r) 2 \cos^2 (45^\circ + \alpha) + \sin 2\alpha = 1,$$

$$1 + \cos (90^\circ + 2\alpha) + \sin 2\alpha = 1 - \sin 2\alpha + \sin 2\alpha = 1.$$

$$21.23. a) \sin 22,5^\circ = \sqrt{\frac{1 - \cos 45^\circ}{2}} = \sqrt{\frac{2 - \sqrt{2}}{4}}.$$

$$b) \cos 22,5^\circ = \sqrt{\frac{1 + \cos 45^\circ}{2}} = \sqrt{\frac{2 + \sqrt{2}}{4}}.$$

$$b) \sin \frac{3\pi}{8} = \sqrt{\frac{1 - \cos \frac{3\pi}{4}}{2}} = \sqrt{\frac{2 + \sqrt{2}}{4}}.$$

$$r) \cos \frac{3\pi}{8} = \sqrt{\frac{1 + \cos \frac{3\pi}{4}}{2}} = \sqrt{\frac{2 - \sqrt{2}}{4}}.$$

$$21.24. a) \sin 2x - 2 \cos x = 0.$$

$$2 \cos x (\sin x - 1) = 0, \quad \cos x = 0, \quad x = \frac{\pi}{2} + \pi n, \quad \sin x = 1, \quad x = \frac{\pi}{2} + 2\pi n, \Rightarrow$$

$$\Rightarrow x = \frac{\pi}{2} + \pi n;$$

$$b) \sin 2x - \sin x = 0,$$

$$\sin x (2 \cos x - 1) = 0, \quad \sin x (2 \cos x - 1) = 0, \quad \sin x = 0,$$

$$x = \pi n, \quad \cos x = \frac{1}{2}, \quad x = \pm \frac{\pi}{3} + 2\pi n;$$

$$b) 2 \sin x = \sin 2x,$$

$$2 \sin x (\cos x - 1) = 0, \quad \sin x = 0, \quad \cos x = 1;$$

$$x = \pi n, \quad x = 2\pi n, \Rightarrow x = \pi n;$$

$$r) \sin 2x + \cos x = 0;$$

$$\cos x(2 \sin x + 1) = 0 \Rightarrow \begin{cases} \cos x = 0 \\ \sin x = -\frac{1}{2} \end{cases} \Rightarrow$$

$$\Rightarrow x = \frac{\pi}{2} + \pi n, n \in \mathbb{Z} \text{ и } x = (-1)^{k+1} \frac{\pi}{6} + \pi k, k \in \mathbb{Z}$$

$$21.25. a) \sin x \cos x = \frac{1}{4}.$$

$$2 \sin x \cos x = \frac{1}{2}, \quad \sin 2x = \frac{1}{2}; \quad 2x = (-1)^n \frac{\pi}{6} + \pi n,$$

$$x = (-1)^n \frac{\pi}{12} + \frac{\pi n}{2};$$

$$б) \sin 4x \cos 4x = \frac{1}{2}.$$

$$\sin 8x = 1, \quad 8x = \frac{\pi}{2} + 2\pi n, \quad x = \frac{\pi}{16} + \frac{\pi n}{4};$$

$$в) \cos^2 \frac{x}{3} - \sin^2 \frac{x}{3} = \frac{1}{2},$$

$$\cos \frac{2x}{3} = \frac{1}{2}, \quad \frac{2x}{3} = \pm \frac{\pi}{3} + 2\pi n, \quad x = \pm \frac{\pi}{2} + 3\pi n;$$

$$г) \sin^2 x - \cos^2 x = \frac{1}{2},$$

$$\cos 2x = -\frac{1}{2}, \quad 2x = \pm \frac{2\pi}{3} + 2\pi n, \quad x = \pm \frac{\pi}{3} + \pi n.$$

$$21.26. a) 1 - \cos x = 2 \sin \frac{x}{2},$$

$$1 - (1 - 2 \sin^2 \frac{x}{2}) = 2 \sin \frac{x}{2}; \quad \sin^2 \frac{x}{2} = \sin \frac{x}{2}; \quad (\sin \frac{x}{2} - 1) \cdot \sin \frac{x}{2} = 0;$$

$$\begin{cases} \sin \frac{x}{2} = 0 \\ \sin \frac{x}{2} = 1 \end{cases}; \quad \begin{cases} x = 2\pi n \\ x = \pi + 4\pi k \end{cases}$$

$$б) 1 + \cos x = 2 \cos \frac{x}{2}.$$

$$1 + (2 \cos^2 \frac{x}{2} - 1) = 2 \cos \frac{x}{2};$$

$$\cos^2 \frac{x}{2} = \cos \frac{x}{2}; \quad (\cos \frac{x}{2} - 1) \cdot \cos \frac{x}{2} = 0;$$

$$\begin{cases} \cos \frac{x}{2} = 0 \\ \cos \frac{x}{2} = 1 \end{cases}; \begin{cases} x = \pi + 2\pi n \\ x = 4\pi k \end{cases}$$

$$21.27. \text{ a) } 1 - \cos x = \sin x \sin \frac{x}{2}.$$

$$1 - (1 - 2\sin^2 \frac{x}{2}) = \sin x \sin \frac{x}{2}; \quad 2\sin^2 \frac{x}{2} = 2\sin^2 \frac{x}{2} \cos \frac{x}{2};$$

$$\sin^2 \frac{x}{2} (1 - \cos \frac{x}{2}) = 0; \quad \begin{cases} \sin \frac{x}{2} = 0 \\ \cos \frac{x}{2} = 1 \end{cases}; \quad \begin{cases} x = 2\pi n \\ x = 4\pi k \end{cases}; \quad x = 2\pi n.$$

$$\text{б) } \sin x = \operatorname{tg}^2 \frac{x}{2} (1 + \cos x),$$

$$\sin x = \frac{1 - \cos x}{1 + \cos x} (1 + \cos x); \quad \begin{cases} \sin x = 1 - \cos x \\ 1 + \cos x \neq 0 \end{cases};$$

$$\begin{cases} \sqrt{2} \sin x \left(x + \frac{\pi}{4}\right) = 1 \\ x \neq \pi + 2\pi n \end{cases}; \quad \begin{cases} x + \frac{\pi}{4} = \frac{\pi}{4} + 2\pi k \\ x + \frac{\pi}{4} = \frac{3\pi}{4} + 2\pi k \\ x \neq \pi + 2\pi n \end{cases}; \quad \begin{cases} x = 2\pi k \\ x = \frac{\pi}{2} + 2\pi k \\ x \neq \pi + 2\pi n \end{cases}; \quad \begin{cases} x = 2\pi k \\ x = \frac{\pi}{2} + 2\pi k \end{cases}.$$

$$21.28. \text{ a) } \sin^2 2x = 1;$$

$$\begin{cases} \sin 2x = 1 \\ \sin 2x = -1 \end{cases}; \quad \begin{cases} 2x = \frac{\pi}{2} + 2\pi n \\ 2x = -\frac{\pi}{2} + 2\pi k \end{cases}; \quad 2x = \frac{\pi}{2} + \pi \ell; \quad x = \frac{\pi}{4} + \frac{\pi \ell}{2}$$

$$\text{б) } \cos^2 4x = \frac{1}{2},$$

$$2\cos^2 4x - 1 = 0; \quad \cos 8x = 0; \quad 8x = \frac{\pi}{2} + \pi n; \quad x = \frac{\pi}{16} + \frac{\pi n}{8}.$$

$$\text{в) } \sin^2 \frac{x}{2} = \frac{3}{4}.$$

$$\begin{cases} \sin \frac{x}{2} = \frac{\sqrt{3}}{2} \\ \sin \frac{x}{2} = -\frac{\sqrt{3}}{2} \end{cases}; \quad \begin{cases} \frac{x}{2} = (-1)^n \frac{\pi}{3} + \pi n \\ \frac{x}{2} = (-1)^k \left(-\frac{\pi}{3}\right) + \pi k \end{cases}; \quad \begin{cases} x = (-1)^n \frac{2\pi}{3} + 2\pi n \\ x = (-1)^k \left(-\frac{2\pi}{3}\right) + 2\pi k \end{cases};$$

$$x = \pm \frac{2\pi}{3} + 2\pi n$$

$$r) \cos^2 \frac{\pi}{11} = \frac{1}{4}.$$

$$\begin{cases} \cos \frac{x}{4} = \frac{1}{2} \\ \cos \frac{x}{4} = -\frac{1}{2} \end{cases}; \begin{cases} \frac{x}{4} = \pm \frac{\pi}{3} + 2\pi n \\ \frac{x}{4} = \pm \frac{2\pi}{3} + 2\pi k \end{cases}; \frac{x}{4} = \pm \frac{\pi}{3} + \pi n; x = \pm \frac{4\pi}{3} + 4\pi n$$

$$21.29. a) \cos 2x + 3 \sin x = 1.$$

$$1 - 2 \sin^2 x + 3 \sin x = 1, \sin x (2 \sin x - 3) = 0, \sin x = 0,$$

$$\sin x = \frac{3}{2} - \text{не существует,}$$

$$x = \pi n, x \in [0, 2\pi] x = 0, \pi, 2\pi;$$

$$б) \sin^2 x = -\cos 2x,$$

$$\sin^2 x + 1 - 2 \sin^2 x = 0, \sin^2 x = 1, \sin x = \pm 1,$$

$$x = \frac{\pi}{2} + \pi n, x \in [0, 2\pi] x = \frac{\pi}{2}, \frac{3}{2}\pi;$$

$$в) \cos 2x = \cos^2 2x, 2 \cos^2 2x - 1 - \cos^2 x = 0, \cos^2 2x = 1, \cos x = \pm 1,$$

$$x = \pi n, x \in [0, 2\pi] x = 0, \pi, 2\pi;$$

$$r) \cos 2x = 2 \sin^2 x,$$

$$1 - 2 \sin^2 x = 2 \sin^2 x, \sin x = \pm \frac{1}{2},$$

$$x = \pm \frac{\pi}{6} + \pi k, x \in [0, 2\pi] x = \frac{\pi}{6}, \frac{5\pi}{6}, \frac{7\pi}{6}, \frac{11\pi}{6}.$$

$$21.30. a) \sin 11^\circ 15' \cdot \cos 11^\circ 15' \cos 22^\circ 30' \cos 45^\circ =$$

$$= \frac{1}{2} \sin 22^\circ 30' \cos 22^\circ 30' \cos 45^\circ = \frac{1}{8} \sin 90^\circ = \frac{1}{8}.$$

$$б) \sin \frac{\pi}{48} \cos \frac{\pi}{48} \cos \frac{\pi}{24} \cos \frac{\pi}{12} = \frac{1}{8} \sin \frac{\pi}{6} = \frac{1}{16}.$$

$$21.31. a) \frac{1 + \cos 40^\circ + \cos 80^\circ}{\sin 80^\circ + \sin 40^\circ} \operatorname{tg} 40^\circ =$$

$$= \frac{2 \cos^2 40^\circ + \cos 40^\circ}{\sin 40^\circ (2 \cos 40^\circ + 1)} \cdot \operatorname{tg} 40^\circ = \operatorname{tg} 40^\circ \operatorname{ctg} 40^\circ = 1$$

$$б) \frac{1 - \cos 25^\circ + \cos 50^\circ}{\sin 50^\circ - \sin 25^\circ} - \operatorname{tg} 65^\circ =$$

$$\frac{2 \cos^2 25^\circ - \cos 25^\circ}{2 \sin 25^\circ \cos 25^\circ - \sin 25^\circ} - \operatorname{tg} 65^\circ = \frac{\cos 25^\circ}{\sin 25^\circ} \cdot \frac{2 \cos 25^\circ - 1}{2 \cos 25^\circ - 1} - \operatorname{tg} 65^\circ =$$

$$= \operatorname{ctg} 25^\circ - \operatorname{tg} 65^\circ = \operatorname{tg} 65^\circ - \operatorname{tg} 65^\circ = 0.$$

$$21.32. a) \sin 3x = 3 \sin x - 4 \sin^3 x.$$

$$\sin 3x = \sin (x + 2x) = \sin x \cos 2x + \sin 2x \cos x =$$

$$= \sin x - 2 \sin^3 x + 2 \sin x - 2 \sin^3 x = 3 \sin x - 4 \sin^3 x.$$

$$\text{б) } \cos 3x = 4 \cos^3 x - 3 \cos x.$$

$$\begin{aligned} \cos(x+2x) &= \cos x \cos 2x - \sin x \sin 2x = 2 \cos^3 x - \cos x - 2 \cos x \sin^2 x = \\ &= 2 \cos^3 x - \cos x - 2 \cos x + 2 \cos^3 x = 4 \cos^3 x - 3 \cos x. \end{aligned}$$

$$\begin{aligned} 21.33. \text{ а) } f(x) &= 2 \cos 2x + \sin^2 x = 2 \cos 2x + \frac{1}{2} (1 - 2 \cos 2x) = \\ &= \frac{3}{2} \cos 2x + \frac{1}{2}. \end{aligned}$$

Поскольку наибольшее значение функции $y = \cos 2x$ равно 1, а наименьшее -1 , то наибольшее значение функции $f(x)$ равно 2, а наименьшее -1 .

$$\text{б) } f(x) = 2 \sin^2 3x - \cos 6x = (1 - \cos 6x) - \cos 6x = 1 - 2 \cos 6x.$$

Поскольку наибольшее значение функции $y = \cos 6x$ равно 1, а наименьшее -1 , то наибольшее значение функции $f(x)$ равно 3, а наименьшее -1 .

$$21.34. \text{ а) } \cos x = \frac{\sin 22,5^\circ \cos 22,5^\circ}{\cos^2 67,5^\circ - \sin^2 67,5^\circ} = \frac{\frac{1}{2} \sin 45^\circ}{\cos 135^\circ} = -\frac{1}{2} \Rightarrow$$

$$x = \pm \frac{2\pi}{3} + 2\pi k \Rightarrow x = -\frac{2\pi}{3} = -120^\circ;$$

$$\text{б) } \sin x = \frac{\sin^2 75^\circ - \cos^2 75^\circ}{4 \sin 15^\circ \cos 15^\circ} = \frac{-\cos 150^\circ}{2 \sin 30^\circ} = +\frac{\sqrt{3}}{2};$$

$$x = (-1)^k \frac{2\pi}{3} + 2\pi k = -\pi - \frac{\pi}{3} = -240^\circ.$$

$$21.35. \text{ а) } 3 \sin 2x + \cos 2x = 1.$$

$$6 \sin x \cos x - 2 \sin^2 x = 0;$$

$$2 \sin x (3 \cos x - \sin x) = 0;$$

$$\sin x = 3 \cos x;$$

$$\operatorname{tg} x = 3; \quad x = \operatorname{arctg} 3 + \pi n, \quad \sin x = 0; \quad x = \pi n;$$

$$\text{б) } \cos 4x + 2 \sin 4x = 1.$$

$$-2 \sin^2 2x + 4 \sin 2x \cos 2x = 0;$$

$$\sin 2x (2 \cos 2x - \sin 2x) = 0.$$

$$\cos 2x = \frac{1}{2} \sin 2x, \quad \operatorname{tg} 2x = 2,$$

$$2x = \operatorname{arctg} 2 + \pi n, \quad x = \frac{1}{2} \operatorname{arctg} 2 + \frac{\operatorname{tg} \frac{\pi}{10}}{\cos \frac{\pi}{5}},$$

$$\sin 2x = 0, \quad 2x = \pi n, \quad x = \frac{\pi n}{2}.$$

$$21.36. \text{ а) } 4 \sin x + \sin 2x = 0, \quad x \in [0; 2\pi]$$

$$2 \sin x (2 + \cos x) = 0, \quad \sin x = 0,$$

$$\cos x = -2 - \text{нет решений}$$

$$x = 0, \quad x = \pi, \quad x = 2\pi.$$

$$б) \cos^2\left(3x + \frac{\pi}{4}\right) - \sin^2\left(3x + \frac{\pi}{4}\right) + \frac{\sqrt{3}}{2} = 0, x \in \left[\frac{3\pi}{4}, \pi\right]$$

$$\cos\left(6x + \frac{2\pi}{4}\right) = -\frac{\sqrt{3}}{2}, \quad \sin 6x = \frac{\sqrt{3}}{2},$$

$$6x = (-1)^k \frac{\pi}{3} + \pi k, \quad x = (-1)^k \frac{\pi}{18} + \frac{\pi k}{6} \Rightarrow$$

$$\Rightarrow x = \frac{5\pi}{6} - \frac{\pi}{18} = \frac{14\pi}{18} = \frac{7\pi}{9}.$$

$$21.37. 2\cos^2 \frac{x}{2} - \cos \frac{\pi}{9} = 1$$

$$(2\cos^2 \frac{x}{2} - 1) = \cos \frac{\pi}{9}; \quad \cos x = \cos \frac{\pi}{9};$$

$$x = \pm \arccos\left(\cos \frac{\pi}{9}\right) + 2\pi n$$

Отсюда имеем, что уравнение на отрезке $[-2\pi, 2\pi]$ имеет 4 корня:

$$\frac{\pi}{9} - 2\pi, -\frac{\pi}{9}, \frac{\pi}{9}, 2\pi - \frac{\pi}{9}.$$

$$21.38. а) (\cos x - \sin x)^2 = 1 - 2 \sin 2x = 2x, x \in \left[\frac{20\pi}{9}, \frac{28\pi}{9}\right]$$

$$1 - \sin 2x = 1 - 2 \sin 2x, \quad \sin 2x = 0, \quad x = \frac{\pi n}{2}, \quad 2 \text{ корня.}$$

$$б) 2 \cos^2\left(2x - \frac{\pi}{4}\right) - 2 \sin^2\left(2x - \frac{\pi}{4}\right) + 1 = 0, x \in \left[\frac{\pi}{2}, \frac{3\pi}{2}\right]$$

$$\cos\left(4x - \frac{\pi}{2}\right) = -\frac{1}{2}, \quad \sin 4x = -\frac{1}{2}, \quad 4x = (-1)^{k+1} \frac{\pi}{6} + \pi k,$$

$$x = (-1)^{k+1} \frac{\pi}{24} + \frac{\pi k}{4}, \quad 3 \text{ корня.}$$

§ 22. Преобразование сумм тригонометрических функций в произведения

$$22.1. а) \sin 40^\circ + \sin 16^\circ = 2\sin \frac{40^\circ + 16^\circ}{2} \cos \frac{40^\circ - 16^\circ}{2} = 2\sin 28^\circ \cos 12^\circ$$

$$б) \sin 20^\circ - \sin 40^\circ = 2\sin \frac{20^\circ - 40^\circ}{2} \cos \frac{20^\circ + 40^\circ}{2} = -2\sin 10^\circ \cos 30^\circ =$$

$$= -\sqrt{3} \sin 10^\circ.$$

$$\text{b) } \sin 10^\circ + \sin 50^\circ = 2 \sin \frac{10^\circ + 50^\circ}{2} \cos \frac{50^\circ - 10^\circ}{2} = 2 \sin 30^\circ \cos 20^\circ = \cos 20^\circ.$$

$$\text{r) } \sin 52^\circ - \sin 36^\circ = 2 \sin \frac{52^\circ - 36^\circ}{2} \cos \frac{52^\circ + 36^\circ}{2} = 2 \sin 8^\circ \cos 44^\circ.$$

22.2.

$$\text{a) } \cos 15^\circ + \cos 45^\circ = 2 \cos \frac{15^\circ + 45^\circ}{2} \cos \frac{45^\circ - 15^\circ}{2} = 2 \cos 30^\circ \cos 15^\circ = \sqrt{3} \cos 15^\circ.$$

$$\text{b) } \cos 46^\circ - \cos 74^\circ = 2 \sin \frac{46^\circ + 74^\circ}{2} \sin \frac{74^\circ - 46^\circ}{2} = 2 \sin 60^\circ \sin 14^\circ = \sqrt{3} \sin 14^\circ.$$

$$\text{b) } \cos 20^\circ + \cos 40^\circ = 2 \cos \frac{20^\circ + 40^\circ}{2} \cos \frac{40^\circ - 20^\circ}{2} = 2 \cos 30^\circ \cos 10^\circ = \sqrt{3} \cos 10^\circ.$$

$$\text{r) } \cos 75^\circ - \cos 15^\circ = 2 \sin \frac{75^\circ + 15^\circ}{2} \sin \frac{15^\circ - 75^\circ}{2} = 2 \sin 45^\circ \sin 30^\circ = -\frac{\sqrt{2}}{2}.$$

$$\text{22.3. a) } \sin \frac{\pi}{5} - \sin \frac{\pi}{10} = 2 \sin \frac{\frac{\pi}{5} - \frac{\pi}{10}}{2} \cos \frac{\frac{\pi}{5} + \frac{\pi}{10}}{2} = 2 \sin \frac{\pi}{20} \cos \frac{3\pi}{20}.$$

$$\text{b) } \sin \frac{\pi}{3} + \sin \frac{\pi}{4} = 2 \sin \frac{\frac{\pi}{3} + \frac{\pi}{4}}{2} \cos \frac{\frac{\pi}{3} - \frac{\pi}{4}}{2} = 2 \sin \frac{7\pi}{24} \cos \frac{\pi}{24}.$$

$$\text{b) } \sin \frac{\pi}{6} + \sin \frac{\pi}{7} = 2 \sin \frac{\frac{\pi}{6} + \frac{\pi}{7}}{2} \cos \frac{\frac{\pi}{6} - \frac{\pi}{7}}{2} = 2 \sin \frac{13\pi}{84} \cos \frac{\pi}{84}.$$

$$\text{r) } \sin \frac{\pi}{3} - \sin \frac{\pi}{11} = 2 \sin \frac{\frac{\pi}{3} - \frac{\pi}{11}}{2} \cos \frac{\frac{\pi}{3} + \frac{\pi}{11}}{2} = 2 \sin \frac{4\pi}{33} \cos \frac{7\pi}{33}.$$

$$\text{22.4. a) } \cos \frac{\pi}{10} - \cos \frac{\pi}{20} = 2 \sin \frac{\frac{\pi}{10} + \frac{\pi}{20}}{2} \sin \frac{\frac{\pi}{20} - \frac{\pi}{10}}{2} = -2 \sin \frac{3\pi}{40} \sin \frac{\pi}{40}.$$

$$\text{b) } \cos \frac{11\pi}{12} + \cos \frac{3\pi}{4} = 2 \cos \frac{\frac{11\pi}{12} + \frac{3\pi}{4}}{2} \cos \frac{\frac{11\pi}{12} - \frac{3\pi}{4}}{2} = 2 \cos \frac{5\pi}{6} \cos \frac{\pi}{12} = -\sqrt{3} \cos \frac{\pi}{12}.$$

$$b) \cos \frac{\pi}{5} - \cos \frac{\pi}{11} = 2 \sin \frac{\frac{\pi}{5} + \frac{\pi}{11}}{2} \sin \frac{\frac{\pi}{5} - \frac{\pi}{11}}{2} = -2 \sin \frac{8\pi}{55} \sin \frac{3\pi}{55}$$

$$r) \cos \frac{3\pi}{8} + \cos \frac{5\pi}{4} = 2 \cos \frac{\frac{3\pi}{8} + \frac{5\pi}{4}}{2} \cos \frac{\frac{3\pi}{8} - \frac{5\pi}{4}}{2} = 2 \cos \frac{13\pi}{16} \cos \frac{7\pi}{16}$$

$$22.5. a) \sin 3t - \sin t = 2 \sin \frac{3t-t}{2} \cos \frac{3t+t}{2} = 2 \sin t \cos 2t$$

$$b) \cos(\alpha-2\beta) - \cos(\alpha+2\beta) = 2 \sin \frac{\alpha-2\beta+\alpha+2\beta}{2} \sin \frac{\alpha+2\beta-\alpha+2\beta}{2} = 2 \sin \alpha \sin 2\beta$$

$$b) \cos 6t + \cos 4t = 2 \cos \frac{6t+4t}{2} \cos \frac{6t-4t}{2} = 2 \cos 5t \cos t$$

$$r) \sin(\alpha-2\beta) - \sin(\alpha+2\beta) = 2 \sin \frac{\alpha-2\beta-\alpha-2\beta}{2} \cos \frac{\alpha-2\beta+\alpha+2\beta}{2} = -2 \sin 2\beta \cos \alpha$$

$$22.6. a) \operatorname{tg} 25^\circ + \operatorname{tg} 35^\circ = \frac{\sin(25^\circ + 35^\circ)}{\cos 25^\circ \cos 35^\circ} = \frac{\sin 60^\circ}{\cos 25^\circ \cos 35^\circ} = \frac{\sqrt{3}}{2 \cos 25^\circ \cos 35^\circ}$$

$$b) \operatorname{tg} \frac{\pi}{5} - \operatorname{tg} \frac{\pi}{10} = \frac{\sin\left(\frac{\pi}{5} - \frac{\pi}{10}\right)}{\cos \frac{\pi}{5} \cos \frac{\pi}{10}} = \frac{\sin \frac{\pi}{10}}{\cos \frac{\pi}{5} \cos \frac{\pi}{10}} = \frac{\operatorname{tg} \frac{\pi}{10}}{\cos \frac{\pi}{5}}$$

$$b) \operatorname{tg} 20^\circ + \operatorname{tg} 40^\circ = \frac{\sin(20^\circ + 40^\circ)}{\cos 20^\circ \cos 40^\circ} = \frac{\sin 60^\circ}{\cos 20^\circ \cos 40^\circ} = \frac{\sqrt{3}}{2 \cos 20^\circ \cos 40^\circ}$$

$$r) \operatorname{tg} \frac{\pi}{3} - \operatorname{tg} \frac{\pi}{4} = \frac{\sin\left(\frac{\pi}{3} - \frac{\pi}{4}\right)}{\cos \frac{\pi}{3} \cos \frac{\pi}{4}} = \frac{\sin \frac{\pi}{12}}{\frac{1}{2} \cdot \frac{\sqrt{2}}{2}} = 2\sqrt{2} \sin \frac{\pi}{12}$$

$$22.7. a) \frac{\cos 68^\circ - \cos 22^\circ}{\sin 68^\circ - \sin 22^\circ} = \frac{2 \sin \frac{68^\circ + 22^\circ}{2} \sin \frac{22^\circ - 68^\circ}{2}}{2 \sin \frac{68^\circ - 22^\circ}{2} \sin \frac{68^\circ + 22^\circ}{2}} = \frac{-\sin 45^\circ \sin 23^\circ}{\sin 23^\circ \cos 45^\circ} = -\operatorname{tg} 45^\circ = -1$$

$$\begin{aligned}
 \text{б) } \frac{\sin 130^\circ + \sin 110^\circ}{\cos 130^\circ + \cos 110^\circ} &= \frac{2 \sin \frac{130^\circ + 110^\circ}{2} \cos \frac{130^\circ - 110^\circ}{2}}{2 \cos \frac{130^\circ + 110^\circ}{2} \cos \frac{130^\circ - 110^\circ}{2}} = \\
 &= \frac{\sin 120^\circ \cos 10^\circ}{\cos 120^\circ \cos 10^\circ} = \frac{\sin 120^\circ}{\cos 120^\circ} = \operatorname{tg} 120^\circ = -\sqrt{3}.
 \end{aligned}$$

$$22.8. \text{ а) } \sin 35^\circ + \sin 25^\circ = \cos 5^\circ.$$

$$\sin 35^\circ + \sin 25^\circ = 2 \sin \frac{35^\circ + 25^\circ}{2} \cos \frac{35^\circ - 25^\circ}{2} = 2 \sin 30^\circ \cos 5^\circ = \cos 5^\circ$$

$$\text{б) } \sin 40^\circ + \cos 70^\circ = \cos 10^\circ.$$

$$\begin{aligned}
 \sin 40^\circ + \cos 70^\circ &= \sin 40^\circ + \sin 20^\circ = 2 \sin \frac{40^\circ + 20^\circ}{2} \cos \frac{40^\circ - 20^\circ}{2} = \\
 &= 2 \sin 30^\circ \cos 10^\circ = \cos 10^\circ
 \end{aligned}$$

$$\text{в) } \cos 12^\circ - \cos 48^\circ = \sin 18^\circ.$$

$$\cos 12^\circ - \cos 48^\circ = 2 \sin \frac{12^\circ + 48^\circ}{2} \sin \frac{48^\circ - 12^\circ}{2} = 2 \sin 30^\circ \sin 18^\circ = \sin 18^\circ$$

$$\text{г) } \cos 20^\circ - \sin 50^\circ = \sin 10^\circ.$$

$$\begin{aligned}
 \cos 20^\circ - \sin 50^\circ &= \cos 20^\circ - \cos 40^\circ = 2 \sin \frac{20^\circ + 40^\circ}{2} \sin \frac{40^\circ - 20^\circ}{2} = \\
 &= 2 \sin 30^\circ \sin 10^\circ = \sin 10^\circ.
 \end{aligned}$$

$$22.9. \text{ а) } \frac{\sin 2\alpha + \sin 6\alpha}{\cos 2\alpha + \cos 6\alpha} = \operatorname{tg} 4\alpha.$$

$$\begin{aligned}
 \frac{\sin 2\alpha + \sin 6\alpha}{\cos 2\alpha + \cos 6\alpha} &= \frac{2 \sin \frac{2\alpha + 6\alpha}{2} \cos \frac{6\alpha - 2\alpha}{2}}{2 \cos \frac{2\alpha + 6\alpha}{2} \cos \frac{6\alpha - 2\alpha}{2}} = \frac{\sin 4\alpha \cos 2\alpha}{\cos 4\alpha \cos 2\alpha} = \\
 &= \frac{\sin 4\alpha}{\cos 4\alpha} = \operatorname{tg} 4\alpha.
 \end{aligned}$$

$$\text{б) } \frac{\cos 2\alpha - \cos 4\alpha}{\cos 2\alpha + \cos 4\alpha} = \operatorname{tg} 3\alpha \operatorname{tg} \alpha.$$

$$\begin{aligned}
 \frac{\cos 2\alpha - \cos 4\alpha}{\cos 2\alpha + \cos 4\alpha} &= \frac{2 \sin \frac{2\alpha + 4\alpha}{2} \sin \frac{4\alpha - 2\alpha}{2}}{2 \cos \frac{2\alpha + 4\alpha}{2} \cos \frac{4\alpha - 2\alpha}{2}} = \frac{\sin 3\alpha \sin \alpha}{\cos 3\alpha \cos \alpha} = \operatorname{tg} 3\alpha \operatorname{tg} \alpha.
 \end{aligned}$$

22.10.

$$\text{а) } \cos x + \cos 3x = 0.$$

$$2 \cos \frac{x+3x}{2} \cos \frac{3x-x}{2} = 0; \quad \cos 2x \cos x = 0;$$

$$\begin{cases} \cos 2x = 0 \\ \cos x = 0 \end{cases} ; \begin{cases} 2x = \frac{\pi}{2} + \pi n \\ x = \frac{\pi}{2} + \pi k \end{cases} ; \begin{cases} x = \frac{\pi}{4} + \frac{\pi n}{2} \\ x = \frac{\pi}{2} + \pi k \end{cases}$$

б) $\sin 12x + \sin 4x = 0$.

$$2 \sin \frac{12x+4x}{2} \cos \frac{12x-4x}{2} = 0; \quad \sin 8x \cos 4x = 0;$$

$$\begin{cases} \sin 8x = 0 \\ \cos 4x = 0 \end{cases} ; \begin{cases} 8x = \pi n \\ 4x = \frac{\pi}{2} + \pi k \end{cases} ; \begin{cases} x = \frac{\pi n}{8} \\ x = \frac{\pi}{8} + \frac{\pi k}{4} \end{cases} ; x = \frac{\pi n}{8}$$

в) $\cos x = \cos 5x$.

$$\cos x - \cos 5x = 0;$$

$$2 \sin \frac{x+5x}{2} \sin \frac{5x-x}{2} = 0; \quad \sin 3x \sin 2x = 0;$$

$$\begin{cases} \sin 3x = 0 \\ \sin 2x = 0 \end{cases} ; \begin{cases} 3x = \pi n \\ 2x = \pi k \end{cases} ; \begin{cases} x = \frac{\pi n}{3} \\ x = \frac{\pi k}{2} \end{cases} ;$$

г) $\sin 3x = \sin 17x$.

$$\sin 17x - \sin 3x = 0;$$

$$2 \sin \frac{17x-3x}{2} \cos \frac{17x+3x}{2} = 0;$$

$$\sin 7x \cos 10x = 0; \begin{cases} \sin 7x = 0 \\ \cos 10x = 0 \end{cases} ; \begin{cases} 7x = \pi n \\ 10x = \frac{\pi}{2} + \pi k \end{cases} ; \begin{cases} x = \frac{\pi n}{7} \\ x = \frac{\pi}{20} + \frac{\pi k}{10} \end{cases}$$

22.11. а) $\sin x + \sin 2x + \sin 3x = 0$.

$$\sin 2x + 2 \sin \frac{x+3x}{2} \cos \frac{3x-x}{2} = 0;$$

$$\sin 2x + 2 \sin 2x \cos x = 0;$$

$$\sin 2x (1 + 2 \cos x) = 0;$$

$$\begin{cases} \sin 2x = 0 \\ \cos x = -\frac{1}{2} \end{cases} ; \begin{cases} 2x = \pi n \\ x = \pm \frac{2\pi}{3} + 2\pi k \end{cases} ; \begin{cases} x = \frac{\pi n}{2} \\ x = \pm \frac{2\pi}{3} + 2\pi k \end{cases}$$

б) $\cos 3x - \cos 5x = \sin 4x$.

$$2 \sin \frac{3x+5x}{2} \sin \frac{5x-3x}{2} = \sin 4x;$$

$$2\sin 4x \sin x - \sin 4x = 0;$$

$$\sin 4x (2 \sin x - 1) = 0;$$

$$\left[\begin{array}{l} \sin 4x = 0 \\ \sin x = \frac{1}{2} \end{array} \right]; \quad \left[\begin{array}{l} 4x = \pi n \\ x = (-1)^k \frac{\pi}{6} + \pi k \end{array} \right]; \quad \left[\begin{array}{l} x = \frac{\pi n}{4} \\ x = (-1)^k \frac{\pi}{6} + \pi k \end{array} \right]$$

$$\begin{aligned} 22.12. \text{ a) } \frac{1}{2} - \cos t &= \cos \frac{\pi}{3} - \cos t = 2 \sin \frac{\frac{\pi}{3} + t}{2} \sin \frac{t - \frac{\pi}{3}}{2} = \\ &= 2 \sin \left(\frac{\pi}{6} + \frac{t}{2} \right) \sin \left(\frac{t}{2} - \frac{\pi}{6} \right). \end{aligned}$$

$$\begin{aligned} \text{б) } \frac{\sqrt{3}}{2} + \sin t &= \sin \frac{\pi}{3} + \sin t = 2 \sin \frac{\frac{\pi}{3} + t}{2} \cos \frac{\frac{\pi}{3} - t}{2} = \\ &= 2 \sin \left(\frac{\pi}{6} + \frac{t}{2} \right) \cos \left(\frac{\pi}{6} - \frac{t}{2} \right). \end{aligned}$$

$$\begin{aligned} \text{в) } 1 + 2\cos t &= 2 \left(\frac{1}{2} + \cos t \right) = 2 \left(\cos \frac{\pi}{3} + \cos t \right) = 4 \cos \frac{\frac{\pi}{3} + t}{2} \cos \frac{\frac{\pi}{3} - t}{2} = \\ &= 4 \cos \left(\frac{\pi}{6} + \frac{t}{2} \right) \cos \left(\frac{\pi}{6} - \frac{t}{2} \right). \end{aligned}$$

$$\begin{aligned} \text{г) } \cos t + \sin t &= \cos t + \cos \left(\frac{\pi}{2} - t \right) = 2 \cos \frac{t + \frac{\pi}{2} - t}{2} \cos \frac{t - \frac{\pi}{2} + t}{2} = \\ &= 2 \cos \frac{\pi}{4} \cos \left(t - \frac{\pi}{4} \right) = \sqrt{2} \cos \left(t - \frac{\pi}{4} \right). \end{aligned}$$

$$\begin{aligned} 22.13. \text{ a) } \sin 5x + 2 \sin 6x + \sin 7x &= (\sin 5x + \sin 7x) + 2 \sin 6x = \\ &= 2 \sin \frac{5x + 7x}{2} \cos \frac{7x - 5x}{2} + 2 \sin 6x = \\ &= 2 \sin 6x \cos x + 2 \sin 6x = 2 \sin 6x (1 + \cos x) = 4 \sin 6x \cos^2 \frac{x}{2}. \end{aligned}$$

$$\begin{aligned} \text{б) } 2\cos x + \cos 2x + \cos 4x &= 2\cos x + 2\cos \frac{2x + 4x}{2} \cos \frac{4x - 2x}{2} = \\ &= 2 \cos x + 2\cos x \cos 3x = 2 \cos x (1 + \cos 3x) = 4 \cos x \cos^2 \frac{3x}{2}. \end{aligned}$$

$$\begin{aligned} 22.14. \text{ a) } \sin t + \sin 2t + \sin 3t + \sin 4t &= (\sin t + \sin 4t) + (\sin 2t + \sin 3t) = \\ &= 2 \sin \frac{t + 4t}{2} \cos \frac{4t - t}{2} + 2 \sin \frac{2t + 3t}{2} \cos \frac{3t - 2t}{2} = \end{aligned}$$

$$= 2 \sin \frac{5t}{2} \cos \frac{3t}{2} + 2 \sin \frac{5t}{2} \cos \frac{t}{2} =$$

$$= 2 \sin \frac{5t}{2} \left(\cos \frac{3t}{2} + \cos \frac{t}{2} \right) = 4 \sin \frac{5t}{2} \cos \frac{\frac{3t}{2} + \frac{t}{2}}{2} \cos \frac{\frac{3t}{2} - \frac{t}{2}}{2} =$$

$$= 4 \sin \frac{5t}{2} \cos t \cos \frac{t}{2}.$$

$$6) \cos 2t - \cos 4t - \cos 6t + \cos 8t = (\cos 2t + \cos 8t) - (\cos 4t + \cos 6t) =$$

$$= 2 \cos \frac{2t+8t}{2} \cos \frac{8t-2t}{2} - 2 \cos \frac{4t+6t}{2} \cos \frac{6t-4t}{2} =$$

$$= 2 \cos 5t \cos 3t - 2 \cos 5t \cos t =$$

$$= 2 \cos 5t (\cos 3t - \cos t) = 4 \cos 5t \sin \frac{3t+t}{2} \sin \frac{t-3t}{2} =$$

$$= -4 \cos 5t \sin 2t \sin t.$$

22.15.

$$a) \sin 20^\circ + \sin 40^\circ - \cos 10^\circ = 0.$$

$$\sin 20^\circ + \sin 40^\circ - \cos 10^\circ = 2 \sin \frac{20^\circ + 40^\circ}{2} \cos \frac{40^\circ - 20^\circ}{2} - \cos 10^\circ =$$

$$= 2 \sin 30^\circ \cos 10^\circ - \cos 10^\circ = 2 \cdot \frac{1}{2} \cdot \cos 10^\circ - \cos 10^\circ = 0.$$

$$6) \cos 85^\circ + \cos 35^\circ - \cos 25^\circ = 0.$$

$$\cos 85^\circ + \cos 35^\circ - \cos 25^\circ = 2 \cos \frac{85^\circ + 35^\circ}{2} \cos \frac{85^\circ - 35^\circ}{2} - \cos 25^\circ =$$

$$= 2 \cos 60^\circ \cos 25^\circ - \cos 25^\circ = 2 \cdot \frac{1}{2} \cdot \cos 25^\circ - \cos 25^\circ = 0.$$

$$\mathbf{22.16. a) \sin 3x = \cos 2x,}$$

$$\sin 3x - \sin \left(\frac{\pi}{2} - 2x \right) = 0;$$

$$2 \sin \frac{3x - \frac{\pi}{2} + 2x}{2} \cos \frac{3x + \frac{\pi}{2} - 2x}{2} = 0;$$

$$\sin \left(\frac{5x}{2} - \frac{\pi}{4} \right) \cos \left(\frac{x}{2} + \frac{\pi}{4} \right) = 0;$$

$$\left[\begin{array}{l} \sin \left(\frac{5x}{2} - \frac{\pi}{4} \right) = 0 \\ \cos \left(\frac{x}{2} + \frac{\pi}{4} \right) = 0 \end{array} \right. ; \left[\begin{array}{l} \frac{5x}{2} - \frac{\pi}{4} = \pi n \\ \frac{x}{2} + \frac{\pi}{4} = \frac{\pi}{2} + \pi k \end{array} \right. ; \left[\begin{array}{l} x = \frac{\pi}{10} + \frac{2\pi n}{5} \\ x = \frac{\pi}{2} + 2\pi k \end{array} \right. ; x = \frac{\pi}{10} + \frac{2\pi n}{5}$$

$$6) \sin(5\pi - x) = \cos(2x + 7\pi).$$

$$\sin x = -\cos 2x;$$

$$\cos 2x + \cos\left(\frac{\pi}{2} - x\right) = 0;$$

$$2 \cos \frac{2x + \frac{\pi}{2} - x}{2} \cos \frac{2x + \frac{\pi}{2} - x}{2} = 0;$$

$$\cos\left(\frac{x}{2} + \frac{\pi}{4}\right) \cos\left(\frac{3x}{2} - \frac{\pi}{4}\right) = 0;$$

$$\begin{cases} \cos\left(\frac{x}{2} + \frac{\pi}{4}\right) = 0 \\ \cos\left(\frac{3x}{2} - \frac{\pi}{4}\right) = 0 \end{cases}; \begin{cases} \frac{x}{2} + \frac{\pi}{4} = \frac{\pi}{2} + \pi n \\ \frac{3x}{2} - \frac{\pi}{4} = \frac{\pi}{2} + \pi k \end{cases}; \begin{cases} x = \frac{\pi}{2} + 2\pi n \\ x = \frac{\pi}{2} + \frac{2\pi k}{3} \end{cases}; x = \frac{\pi}{2} + \frac{2\pi k}{3}.$$

$$b) \cos 5x = \sin 15x$$

$$\cos 5x - \cos\left(\frac{\pi}{2} - 2x\right) = 0;$$

$$2 \sin \frac{5x + \frac{\pi}{2} - 15x}{2} \sin \frac{\frac{\pi}{2} - 15x - 5x}{2} = 0;$$

$$\sin\left(\frac{5x}{2} - \frac{\pi}{4}\right) \sin\left(\frac{\pi}{4} - 10x\right) = 0; \sin\left(5x - \frac{\pi}{4}\right) \sin\left(10x - \frac{\pi}{4}\right) = 0;$$

$$\begin{cases} \sin\left(\frac{5x}{2} - \frac{\pi}{4}\right) = 0 \\ \sin\left(\frac{x}{2} + \frac{\pi}{4}\right) = 0 \end{cases}; \begin{cases} \frac{5x}{2} - \frac{\pi}{4} = \pi n \\ \frac{x}{2} + \frac{\pi}{4} = \frac{\pi}{2} + \pi k \end{cases}; \begin{cases} x = \frac{\pi}{20} + \frac{\pi n}{5} \\ x = \frac{\pi}{40} + \frac{\pi k}{10} \end{cases}.$$

$$r) \sin(7\pi + x) = \cos(9\pi + 2x).$$

$$-\sin x = -\cos 2x; \cos 2x - \sin x = 0; \cos 2x - \cos\left(\frac{\pi}{2} - x\right) = 0;$$

$$2 \sin \frac{2x + \frac{\pi}{2} - x}{2} \sin \frac{2x + \frac{\pi}{2} - x}{2} = 0;$$

$$\sin\left(\frac{x}{2} + \frac{\pi}{4}\right) \sin\left(\frac{\pi}{4} - \frac{3x}{2}\right) = 0; \sin\left(\frac{x}{2} + \frac{\pi}{4}\right) \sin\left(\frac{3x}{2} - \frac{\pi}{4}\right) = 0;$$

$$\begin{cases} \sin\left(\frac{x}{2} + \frac{\pi}{4}\right) = 0 \\ \sin\left(\frac{3x}{2} - \frac{\pi}{4}\right) = 0 \end{cases}; \begin{cases} \frac{x}{2} + \frac{\pi}{4} = \pi n \\ \frac{3x}{2} - \frac{\pi}{4} = \pi k \end{cases}; \begin{cases} x = -\frac{\pi}{2} + 2\pi n \\ x = \frac{\pi}{6} + \frac{2\pi k}{3} \end{cases}; x = \frac{\pi}{6} + \frac{2\pi k}{3}.$$

$$22.17. \text{ a) } 1 + \cos 6x = 2 \sin^2 5x$$

$$1 + \cos 6x = 1 - \cos 10x; \cos 6x + \cos 10x = 0;$$

$$2 \cos \frac{6x+10x}{2} \cos \frac{10x-6x}{2} = 0;$$

$$\cos 8x \cos 2x = 0;$$

$$\begin{cases} \cos 8x = 0 \\ \cos 2x = 0 \end{cases}; \begin{cases} 8x = \frac{\pi}{2} + \pi k \\ 2x = \frac{\pi}{2} + \pi n \end{cases}; \begin{cases} x = \frac{\pi}{16} + \frac{\pi k}{8} \\ x = \frac{\pi}{4} + \frac{\pi n}{2} \end{cases}$$

$$\text{б) } \cos^2 2x = \cos^2 4x.$$

$$\frac{1}{2}(1 + \cos 4x) = \frac{1}{2}(1 + \cos 8x);$$

$$\cos 4x - \cos 8x = 0;$$

$$2 \sin \frac{4x+8x}{2} \sin \frac{8x-4x}{2} = 0; \quad \sin 6x \sin 2x = 0;$$

$$\begin{cases} \sin 6x = 0 \\ \sin 2x = 0 \end{cases}; \begin{cases} 6x = \pi n \\ 2x = \pi k \end{cases}; \begin{cases} x = \frac{\pi n}{6} \\ x = \frac{\pi k}{2} \end{cases}; \quad x = \frac{\pi n}{6}.$$

$$\text{в) } \sin^2 \frac{x}{2} = \cos^2 \frac{7x}{2}$$

$$\frac{1}{2}(1 - \cos x) = \frac{1}{2}(1 + \cos 7x); \quad \cos 7x + \cos x = 0;$$

$$2 \cos \frac{7x+x}{2} \cos \frac{7x-x}{2} = 0; \quad \cos 4x \cos 3x = 0;$$

$$\begin{cases} \cos 4x = 0 \\ \cos 3x = 0 \end{cases}; \begin{cases} 4x = \frac{\pi}{2} + \pi n \\ 3x = \frac{\pi}{2} + \pi k \end{cases}; \begin{cases} x = \frac{\pi}{8} + \frac{\pi n}{4} \\ x = \frac{\pi}{6} + \frac{\pi k}{3} \end{cases}$$

$$\text{г) } \sin^2 x + \sin^2 3x = 1.$$

$$\frac{1}{2}(1 - \cos 2x) + \frac{1}{2}(1 - \cos 6x); \quad \cos 2x + \cos 6x = 0;$$

$$2 \cos \frac{2x+6x}{2} \cos \frac{6x-2x}{2} = 0; \quad \cos 4x \cos 2x = 0;$$

$$\begin{cases} \cos 4x = 0 \\ \cos 2x = 0 \end{cases}; \begin{cases} 4x = \frac{\pi}{2} + \pi n \\ 2x = \frac{\pi}{2} + \pi k \end{cases}; \begin{cases} x = \frac{\pi}{8} + \frac{\pi n}{4} \\ x = \frac{\pi}{4} + \frac{\pi k}{2} \end{cases}$$

$$22.18. \text{ a) } 2\sin^2 x + \cos 5x = 1.$$

$$1 - \cos 2x + \cos 5x = 1;$$

$$\cos 5x - \cos 2x = 0;$$

$$\begin{cases} \sin \frac{7x}{2} = 0 \\ \sin \frac{3x}{2} = 0 \end{cases}; \begin{cases} \frac{7x}{2} = \pi n \\ \frac{3x}{2} = \pi k \end{cases}; \begin{cases} x = \frac{2\pi n}{7} \\ x = \frac{2\pi k}{3} \end{cases}$$

$$\text{б) } 2\sin^2 3x - 1 = \cos^2 4x - \sin^2 4x$$

$$- \cos 6x = \cos 8x;$$

$$\cos 6x + \cos 8x = 0;$$

$$2 \cos \frac{6x+10x}{2} \cos \frac{8x-6x}{2} = 0;$$

$$\cos 7x \cos x = 0;$$

$$\begin{cases} \cos 8x = 0 \\ \cos 2x = 0 \end{cases}; \begin{cases} 8x = \frac{\pi}{2} + \pi k \\ 2x = \frac{\pi}{2} + \pi n \end{cases}; \begin{cases} x = \frac{\pi}{16} + \frac{\pi k}{8} \\ x = \frac{\pi}{4} + \frac{\pi n}{2} \end{cases}$$

$$22.19. \text{ a) } \operatorname{tg} x + \operatorname{tg} 5x = 0.$$

$$\frac{\sin(x+5x)}{\cos x \cos 5x} = 0; \frac{\sin 6x}{\cos x \cos 5x} = 0;$$

$$\begin{cases} \sin 6x = 0 \\ \cos x \neq 0 \\ \cos 5x \neq 0 \end{cases}; \begin{cases} 6x = \pi n \\ x \neq \frac{\pi}{2} + \pi k \\ 5x \neq \frac{\pi}{2} + \pi \ell \end{cases}; \begin{cases} x = \frac{\pi n}{6} \\ x \neq \frac{\pi}{2} + \pi k \\ x \neq \frac{\pi}{10} + \frac{\pi \ell}{5} \end{cases}; \begin{cases} x = \frac{\pi n}{6} \\ x \neq \frac{\pi}{2} + \pi k \end{cases}$$

$$\text{б) } \operatorname{tg} 3x = \operatorname{ctg} x.$$

$$\frac{\sin 3x}{\cos 3x} = \frac{\cos x}{\sin x}; \begin{cases} \sin 3x \sin x = \cos 3x \cos x \\ \cos 3x \neq 0 \\ \sin x \neq 0 \end{cases};$$

$$\begin{cases} \cos 3x \cos x - \sin 3x \sin x = 0 \\ \cos 3x \neq 0 \\ \sin x \neq 0 \end{cases}; \begin{cases} \cos(3x+x) = 0 \\ \cos 3x \neq 0 \\ \sin x \neq 0 \end{cases};$$

$$\begin{cases} \cos 4x = 0 \\ \cos 3x \neq 0 \\ \sin x \neq 0 \end{cases}; \begin{cases} 4x = \frac{\pi}{2} + \pi n \\ 3x \neq \frac{\pi}{2} + \pi k \\ x \neq \pi \ell \end{cases}; \begin{cases} x = \frac{\pi}{8} + \frac{\pi n}{4} \\ x \neq \frac{\pi}{6} + \frac{\pi k}{3} \\ x \neq \pi \ell \end{cases}; x = \frac{\pi}{8} + \frac{\pi n}{4}.$$

$$b) \operatorname{tg} 2x = \operatorname{tg} 4x.$$

$$\frac{\sin 2x}{\cos 2x} = \frac{\sin 4x}{\cos 4x} ; \begin{cases} \sin 2x \cos 4x = \sin 4x \cos 2x \\ \cos 2x \neq 0 \\ \cos 4x \neq 0 \end{cases} ;$$

$$\begin{cases} \sin(4x - 2x) = 0 \\ \cos 2x \neq 0 \\ \cos 4x \neq 0 \end{cases} ; \begin{cases} \sin 2x = 0 \\ \cos 2x \neq 0 \\ \cos 4x \neq 0 \end{cases} ; \begin{cases} 2x = \pi n \\ 2x \neq \frac{\pi}{2} + \pi k \\ 4x \neq \frac{\pi}{2} + \pi \ell \end{cases} ; \begin{cases} x = \frac{\pi n}{2} \\ x \neq \frac{\pi}{4} + \frac{\pi k}{2} \\ x \neq \frac{\pi}{8} + \frac{\pi \ell}{4} \end{cases} ; x = \frac{\pi n}{2}.$$

$$r) \operatorname{ctg} \frac{x}{2} + \operatorname{ctg} \frac{3x}{2} = 0.$$

$$\frac{\cos \frac{x}{2}}{\sin \frac{x}{2}} + \frac{\cos \frac{3x}{2}}{\sin \frac{3x}{2}} = 0 ;$$

$$\begin{cases} \cos \frac{x}{2} \sin \frac{3x}{2} + \cos \frac{3x}{2} \sin \frac{x}{2} = 0 \\ \sin \frac{x}{2} \neq 0 \\ \sin \frac{3x}{2} \neq 0 \end{cases} ; \begin{cases} \sin \left(\frac{3x}{2} + \frac{x}{2} \right) = 0 \\ \sin \frac{x}{2} \neq 0 \\ \sin \frac{3x}{2} \neq 0 \end{cases} ;$$

$$\begin{cases} \sin 2x = 0 \\ \sin \frac{x}{2} \neq 0 \\ \sin \frac{3x}{2} \neq 0 \end{cases} ; \begin{cases} 2x = \pi n \\ \frac{x}{2} \neq \pi k \\ \frac{3x}{2} \neq \pi \ell \end{cases} ; \begin{cases} x = \frac{\pi n}{2} \\ x \neq 2\pi k \\ x \neq \frac{2\pi \ell}{3} \end{cases} ; \begin{cases} x = \frac{\pi n}{2} \\ n \neq 4k \varepsilon \\ 3n \neq 4\ell \end{cases} ; \begin{cases} x = \frac{\pi}{2} + \pi k \\ x = \pi + 2\pi n \end{cases}.$$

$$22.20. a) \sin x + \sin 3x + \cos x + \cos 3x = 0.$$

$$2 \sin \frac{x+3x}{2} \cos \frac{3x-x}{2} + 2 \cos \frac{x+3x}{2} \cos \frac{3x-x}{2} = 0;$$

$$\sin 2x \cos x + \cos 2x \cos x = 0; \cos x (\sin 2x + \cos 2x) = 0;$$

$$\sqrt{2} \cos x \cdot \sin \left(\frac{\pi}{4} + 2x \right) = 0;$$

$$\begin{cases} \cos x = 0 \\ \sin \left(\frac{\pi}{4} + 2x \right) = 0 \end{cases} ; \begin{cases} x = \frac{\pi}{2} + \pi n \\ \frac{\pi}{4} + 2x = \pi k \end{cases} ; \begin{cases} x = \frac{\pi}{2} + \pi n \\ x = -\frac{\pi}{8} + \frac{\pi k}{2} \end{cases} \varepsilon.$$

$$6) \sin 5x + \sin x + 2\sin^2 x = 1.$$

$$\sin 5x + \sin x - \cos 2x = 0;$$

$$2 \sin \frac{5x+x}{2} \cos \frac{5x-x}{2} - \cos 2x = 0;$$

$$2\sin 3x \cos 2x - \cos 2x = 0;$$

$$\cos 2x (2\sin 3x - 1) = 0;$$

$$\begin{cases} \cos 2x = 0 \\ \sin 3x = \frac{1}{2} \end{cases}; \begin{cases} 2x = \frac{\pi}{2} + \pi n \\ 3x = (-1)^k \frac{\pi}{6} + \pi k \end{cases}; \begin{cases} x = \frac{\pi}{4} + \frac{\pi n}{2} \\ x = (-1)^k \frac{\pi}{18} + \frac{\pi k}{3} \end{cases}.$$

$$22.21. a) \sin 2x + \sin 6x = \cos 2x$$

$$2 \sin \frac{x+3x}{2} \cos \frac{6x-2x}{2} - \cos 2x = 0;$$

$$2\sin 4x \cos 2x - \cos 2x = 0; \quad \cos 2x (2\sin 4x - 1) = 0;$$

$$\begin{cases} \cos 2x = 0 \\ \sin 4x = \frac{1}{2} \end{cases}; \begin{cases} 2x = \frac{\pi}{2} + \pi n \\ 4x = (-1)^k \frac{\pi}{6} + \pi k \end{cases}; \begin{cases} x = \frac{\pi}{4} + \frac{\pi n}{2} \\ x = \frac{\pi}{24} + 2\pi k \\ x = \frac{5\pi}{24} + 2\pi k \end{cases}.$$

Отсюда видно, что данное уравнение имеет на отрезке $[0, \frac{\pi}{2}]$ 3 корня:

$$x = \frac{\pi}{4}, x = \frac{\pi}{24} \text{ и } x = \frac{5\pi}{24}.$$

$$6) 2 \cos^2 x - 1 = \sin 3x$$

$$\cos 2x = \sin 3x; \quad \cos 2x - \cos\left(\frac{\pi}{2} - 3x\right) = 0;$$

$$2\sin \frac{2x + \frac{\pi}{2} - 3x}{2} \sin \frac{\frac{\pi}{2} - 3x - 2x}{2} = 0;$$

$$\sin\left(\frac{\pi}{4} - \frac{x}{2}\right) \sin\left(\frac{\pi}{4} - \frac{5x}{2}\right) = 0; \quad \sin\left(\frac{\pi}{4} - \frac{x}{2}\right) \sin\left(\frac{5x}{2} - \frac{\pi}{4}\right) = 0;$$

$$\begin{cases} \sin\left(\frac{x}{2} - \frac{\pi}{4}\right) = 0 \\ \sin\left(\frac{5x}{2} - \frac{\pi}{4}\right) = 0 \end{cases}; \begin{cases} \frac{x}{2} - \frac{\pi}{4} = \pi n \\ \frac{5x}{2} - \frac{\pi}{4} = \pi k \end{cases}; \begin{cases} x = \frac{\pi}{2} + 2\pi n \\ x = \frac{\pi}{10} + \frac{2\pi k}{5} \end{cases}.$$

Отсюда видно, что данное уравнение имеет на отрезке $[0, \frac{\pi}{2}]$ 2 корня:

$$x = \frac{\pi}{4} \text{ и } x = \frac{\pi}{2}.$$

$$22.22. \text{ а) } \cos 6x + \cos 8x = \cos 10x + \cos 12x$$

$$2 \cos \frac{6x+8x}{2} \cos \frac{8x-6x}{2} = 2 \cos \frac{10x+12x}{2} \cos \frac{12x-10x}{2};$$

$$\cos 7x \cos x = \cos 11x \cos x;$$

$$\cos x (\cos 7x - \cos 11x) = 0;$$

$$2 \cos x \sin \frac{7x+11x}{2} \sin \frac{11x-7x}{2} = 0;$$

$$\cos x \sin 9x \sin 2x = 0;$$

$$\begin{cases} \cos x = 0 \\ \sin 9x = 0 \\ \sin 2x = 0 \end{cases} \begin{cases} x = \frac{\pi}{2} + \pi n \\ x = \frac{\pi k}{9} \\ x = \frac{\pi l}{2} \end{cases}, \begin{cases} x = \frac{\pi k}{2} \\ x = \frac{\pi n}{9} \end{cases} \text{ т.к. } x \in (0; 2,5), \text{ то}$$

$$x = \frac{\pi}{2}, \frac{\pi}{9}, \frac{2\pi}{9}, \frac{\pi}{3}, \frac{4\pi}{9}, \frac{5\pi}{9}, \frac{2\pi}{3}, \frac{7\pi}{9};$$

$$\text{б) } \sin 2x + 5 \sin 4x + \sin 6x = 0. (\sin 2x + \sin 6x) + 5 \sin 4x = 0;$$

$$2 \sin 4x \cos 2x + 5 \sin 4x = 0; \sin 4x (2 \cos 2x + 5) = 0;$$

$$\sin 4x = 0 \text{ (т.к. } 2 \cos 2x + 5 > 0 \text{ при всех } x); 4x = \pi n; x = \frac{\pi n}{4}.$$

$$\text{Т.к. } x \in (0; 2,5), \text{ то } x = \frac{\pi}{4}, \frac{\pi}{2}, \frac{3\pi}{4}.$$

§ 23. Преобразование произведения тригонометрических функций в суммы

$$23.1. \text{ а) } \sin 23^\circ \sin 32^\circ = \frac{1}{2} (\cos (32^\circ - 23^\circ) - \cos (32^\circ + 23^\circ)) =$$

$$= \frac{1}{2} (\cos 9^\circ - \cos 55^\circ).$$

$$\text{б) } \cos \frac{\pi}{12} \cos \frac{\pi}{8} = \frac{1}{2} \left(\cos \left(\frac{\pi}{8} - \frac{\pi}{12} \right) + \cos \left(\frac{\pi}{8} + \frac{\pi}{12} \right) \right) =$$

$$= \frac{1}{2} \left(\cos \frac{\pi}{24} + \cos \frac{5\pi}{24} \right).$$

$$\text{в) } \sin 14^\circ \sin 16^\circ = \frac{1}{2} (\cos (16^\circ - 14^\circ) - \cos (16^\circ + 14^\circ)) =$$

$$= \frac{1}{2} (\cos 2^\circ - \cos 30^\circ) = \frac{1}{2} \left(\cos 2^\circ - \frac{\sqrt{3}}{2} \right).$$

$$r) 2 \sin \frac{\pi}{8} \cos \frac{\pi}{5} = \sin \left(\frac{\pi}{8} + \frac{\pi}{5} \right) + \sin \left(\frac{\pi}{8} - \frac{\pi}{5} \right) = \sin \frac{13\pi}{40} - \sin \frac{3\pi}{40}$$

$$23.2. a) \sin(\alpha + \beta) \sin(\alpha - \beta) = \sin^2 \alpha - \sin^2 \beta = \cos^2 \beta - \cos^2 \alpha = \\ = \frac{1}{2}(\cos 2\beta - \cos 2\alpha).$$

$$b) \cos(\alpha + \beta) \cos(\alpha - \beta) = \cos^2 \beta - \sin^2 \alpha = \cos^2 \alpha - \sin^2 \beta = \\ = \frac{1}{2}(\cos 2\beta + \cos 2\alpha);$$

$$b) \cos \left(\frac{\alpha + \beta}{2} \right) \cos \left(\frac{\alpha - \beta}{2} \right) = \cos^2 \frac{\beta}{2} - \sin^2 \frac{\alpha}{2} = \cos^2 \frac{\alpha}{2} - \sin^2 \frac{\beta}{2} = \\ = \frac{1}{2}(\cos \beta + \cos \alpha);$$

$$r) 2 \sin(\alpha + \beta) \cos(\alpha - \beta) = \sin 2\alpha + \sin 2\beta.$$

$$23.3. a) \cos \alpha \sin(\alpha + \beta) = \frac{1}{2}(\sin(2\alpha + \beta) + \sin(\alpha + \beta - \alpha)) = \\ = \frac{1}{2}(\sin(2\alpha + \beta) + \sin \beta).$$

$$b) \sin(60^\circ + \alpha) \sin(60^\circ - \alpha) = \frac{1}{2}(\cos 2\alpha - \cos 120^\circ) = \frac{1}{2} \left(\cos 2\alpha + \frac{1}{2} \right).$$

$$b) \sin \beta \cos(\alpha + \beta) = \frac{1}{2}(\sin(\alpha + 2\beta) + \sin(\beta - \alpha - \beta)) = \\ = \frac{1}{2}(\sin(\alpha + 2\beta) - \sin \alpha).$$

$$r) \cos \left(\alpha + \frac{\pi}{4} \right) \cos \left(\alpha - \frac{\pi}{4} \right) = \frac{1}{2} \left(\cos 2\alpha + \cos \frac{\pi}{2} \right) = \frac{1}{2} \cos 2\alpha.$$

$$23.4. a) \cos \left(x + \frac{\pi}{3} \right) \cos \left(x - \frac{\pi}{3} \right) - 0,25 = 0;$$

$$\frac{1}{2} \left(\cos \left(\frac{\pi}{8} - \frac{\pi}{12} \right) + \cos \left(\frac{\pi}{8} + \frac{\pi}{12} \right) \right) = \frac{1}{4};$$

$$\frac{1}{2} \left(\cos \frac{2\pi}{3} + \cos 2x \right) = \frac{1}{4}; \quad \frac{1}{2} \left(-\frac{1}{2} + \cos 2x \right) = \frac{1}{4};$$

$$\cos 2x = 1; \quad 2x = 2\pi n; \quad x = \pi n;$$

$$b) \sin \left(x + \frac{\pi}{3} \right) \cos \left(x + \frac{\pi}{3} \right) = 1.$$

$$\frac{1}{2} \left(\sin \left(x + \frac{\pi}{3} + x - \frac{\pi}{6} \right) + \sin \left(x + \frac{\pi}{3} - x + \frac{\pi}{6} \right) \right) = 1;$$

$$\frac{1}{2} \left(\sin \left(2x + \frac{\pi}{6} \right) + \sin \frac{\pi}{2} \right) = 1;$$

$$\frac{1}{2} \sin \left(2x + \frac{\pi}{6} \right) + \frac{1}{2} = 1; \quad \sin \left(2x + \frac{\pi}{6} \right) + \frac{1}{2} = 1;$$

$$2x + \frac{\pi}{6} = \frac{\pi}{2} + 2\pi n; \quad x = \frac{\pi}{6} + \pi n$$

$$23.5. \text{ a) } 2 \sin x \cos 3x + \sin 4x = 0.$$

$$\sin(x + 3x) + \sin(x - 3x) + \sin 4x = 0;$$

$$2 \sin 4x - \sin 2x = 0;$$

$$4 \sin 2x \cos 2x - \sin 2x = 0;$$

$$\sin 2x (4 \cos 2x - 1) = 0;$$

$$\begin{cases} \sin 2x = 0 \\ \cos 2x = \frac{1}{4} \end{cases}; \quad \begin{cases} 2x = \pi n \\ 2x = \pm \arccos \frac{1}{4} + 2\pi k \end{cases}; \quad \begin{cases} x = \frac{\pi n}{2} \\ x = \pm \frac{1}{2} \arccos \frac{1}{4} + \pi k \end{cases}$$

$$\text{б) } \sin \frac{x}{2} \sin \frac{3x}{2} = \frac{1}{2}, \quad \frac{1}{2} \left(\cos \left(\frac{x}{2} - \frac{3x}{2} \right) - \cos \left(\frac{x}{2} + \frac{3x}{2} \right) \right) = \frac{1}{2};$$

$$\cos x - \cos 2x = 1; \quad 2 \cos^2 x - \cos x = 0; \quad \cos x (2 \cos x - 1) = 0;$$

$$\begin{cases} \cos x = 0 \\ \cos x = \frac{1}{2} \end{cases}; \quad \begin{cases} x = \frac{\pi}{2} + \pi n \\ x = \pm \frac{\pi}{3} + 2\pi k \end{cases}$$

$$23.6. \text{ a) } 2 \sin t \sin 2t + \cos 3t = \cos t.$$

$$2 \sin t \sin 2t + \cos 3t = \cos(2t - t) - \cos(2t + t) + \cos 3t = \cos t.$$

$$\text{б) } \sin \alpha - 2 \sin \left(\frac{\alpha}{2} - 15^\circ \right) \cos \left(\frac{\alpha}{2} + 15^\circ \right) = \frac{1}{2}.$$

$$\sin \alpha - 2 \sin \left(\frac{\alpha}{2} - 15^\circ \right) \cos \left(\frac{\alpha}{2} + 15^\circ \right) = \sin \alpha -$$

$$- \sin \left(\frac{\alpha}{2} - 15^\circ + \frac{\alpha}{2} + 15^\circ \right) - \sin \left(\frac{\alpha}{2} - 15^\circ - \frac{\alpha}{2} - 15^\circ \right) =$$

$$= \sin \alpha - \sin \alpha - \sin(-30^\circ) = \sin 30^\circ = \frac{1}{2}.$$

$$23.7. \text{ a) } \sin 10^\circ \cos 8^\circ \cos 6^\circ = \frac{1}{2} \sin 10^\circ (\cos(8^\circ - 6^\circ) + \cos(8^\circ + 6^\circ)) =$$

$$= \frac{1}{2} \sin 10^\circ \cos 2^\circ + \frac{1}{2} \sin 10^\circ \cos 14^\circ =$$

$$= \frac{1}{4} (\sin 12^\circ + \sin 8^\circ + \sin 24^\circ - \sin 4^\circ).$$

$$\begin{aligned}
 6) & 4 \sin 25^\circ \cos 15^\circ \sin 5^\circ = 2 \sin 25^\circ (\sin 20^\circ + \sin (-10^\circ)) = \\
 & = 2 (\sin 25^\circ \sin 20^\circ - \sin 25^\circ \sin 10^\circ) = \\
 & = \cos 5^\circ - \cos 45^\circ - \cos 15^\circ + \cos 35^\circ = \\
 & = \cos 5^\circ - \cos 15^\circ + \cos 35^\circ - \frac{1}{\sqrt{2}}
 \end{aligned}$$

$$23.8. a) \cos^2 3^\circ + \cos^2 1^\circ - \cos 4^\circ \cos 2^\circ = \cos^2 3^\circ + \cos^2 1^\circ - \cos(3^\circ + 1^\circ) \cos(3^\circ - 1^\circ) = \\
 = \cos^2 3^\circ + \cos^2 1^\circ - \cos^2 1^\circ + \sin^2 3^\circ = \cos^2 3^\circ + \sin^2 3^\circ = 1$$

$$\begin{aligned}
 6) & \sin^2 10^\circ + \cos 50^\circ \cos 70^\circ = \sin^2 10^\circ + \cos(60^\circ - 10^\circ) \cos(60^\circ + 10^\circ) = \\
 & = \sin^2 10^\circ + \cos^2 60^\circ - \sin^2 10^\circ = \cos^2 60^\circ = \frac{1}{4}.
 \end{aligned}$$

$$\begin{aligned}
 23.9. a) & \frac{1}{2 \sin 10^\circ} - 2 \sin 70^\circ = \frac{1 - 4 \sin 10^\circ \sin 70^\circ}{2 \sin 10^\circ} = \\
 & = \frac{1 - 2 \cos(70^\circ - 10^\circ) + 2 \cos(70^\circ + 10^\circ)}{2 \sin 10^\circ} = \frac{1 - 2 \cos 60^\circ + 2 \cos 80^\circ}{2 \sin 10^\circ} = \\
 & = \frac{1 - 2 \cdot \frac{1}{2} + 2 \sin 10^\circ}{2 \sin 10^\circ} = 1.
 \end{aligned}$$

$$\begin{aligned}
 6) & \frac{\operatorname{tg} 60^\circ}{\sin 40^\circ} + 4 \cos 100^\circ = \frac{\operatorname{tg} 60^\circ + 4 \sin 40^\circ \cos 100^\circ}{\sin 40^\circ} = \\
 & = \frac{\operatorname{tg} 60^\circ + 2 \sin 140^\circ + 2 \sin(-60^\circ)}{\sin 40^\circ} = \frac{\sqrt{3} + 2 \sin 40^\circ - 2 \cdot \frac{\sqrt{3}}{2}}{\sin 40^\circ} = \\
 & = \frac{2 \sin 40^\circ}{\sin 40^\circ} = 2.
 \end{aligned}$$

$$23.10. a) \sin 3x \cos x = \sin \frac{5x}{2} \cos \frac{3x}{2}.$$

$$\frac{1}{2} (\sin(3x + x) + \sin(3x - x)) = \frac{1}{2} \left(\sin\left(\frac{5x}{2} + \frac{3x}{2}\right) + \sin\left(\frac{5x}{2} - \frac{3x}{2}\right) \right);$$

$$\sin 4x + \sin 2x = \sin 4x + \sin x;$$

$$\sin 2x - \sin x = 0;$$

$$2 \sin \frac{2x - x}{2} \cos \frac{2x + x}{2} = 0;$$

$$\sin \frac{x}{2} \cos \frac{3x}{2} = 0;$$

$$\left[\begin{array}{l} \sin \frac{x}{2} = 0 \\ \cos \frac{3x}{2} = 0 \end{array} \right]; \quad \left[\begin{array}{l} \frac{x}{2} = \pi n \\ \frac{3x}{2} = \frac{\pi}{2} + \pi k \end{array} \right]; \quad \left[\begin{array}{l} x = 2\pi n \\ x = \frac{\pi}{3} + \frac{2\pi k}{3} \end{array} \right].$$

$$6) 2 \sin \left(\frac{\pi}{4} + x \right) \sin \left(\frac{\pi}{4} - x \right) + \sin^2 x = 0.$$

$$2 \left(\sin^2 \frac{\pi}{4} - \sin^2 x \right) + \sin^2 x = 0;$$

$$1 - \sin^2 x = 0; \quad -\frac{1}{2} (1 - \cos 2x) + 1 = 0; \quad \cos 2x = -1;$$

$$2x = \pi + 2\pi n; \quad x = \frac{\pi}{2} + \pi n.$$

$$в) \sin 2x \cos x = \sin x \cos 2x.$$

$$\frac{1}{2} (\sin 3x + \sin x) = \frac{1}{2} (\sin 3x - \sin x); \quad \sin x = 0; \quad x = \pi n.$$

$$г) \cos 2x \cos x = \cos 2.5x \cos 0.5x.$$

$$\frac{1}{2} (\cos x + \cos 3x) = \frac{1}{2} (\cos 2x + \cos 3x);$$

$$\cos x = \cos 2x; \quad \cos x - \cos 2x = 0;$$

$$2 \sin \frac{x+2x}{2} \sin \frac{2x-x}{2} = 0; \quad \sin \frac{3x}{2} \sin \frac{x}{2} = 0;$$

$$\begin{cases} \sin \frac{3x}{2} = 0 \\ \sin \frac{x}{2} = 0 \end{cases}; \quad \begin{cases} \frac{3x}{2} = \pi n \\ \frac{x}{2} = \pi k \end{cases}; \quad \begin{cases} x = \frac{2\pi n}{3} \\ x = 2\pi k \end{cases}.$$

$$23.11. а) \sin x \sin 3x = 0,5.$$

$$\frac{1}{2} (\cos 2x - \cos 4x) = \frac{1}{2}; \quad \cos 2x = 1 + \cos 4x;$$

$$\cos 2x = 2 \cos^2 2x; \quad \cos 2x (2 \cos 2x - 1) = 0;$$

$$\begin{cases} \cos 2x = 0 \\ \cos 2x = \frac{1}{2} \end{cases}; \quad \begin{cases} 2x = \frac{\pi}{2} + \pi n \\ 2x = \pm \frac{\pi}{3} + 2\pi k \end{cases}; \quad \begin{cases} x = \frac{\pi}{4} + \frac{\pi n}{2} \\ x = \pm \frac{\pi}{6} + \pi k \end{cases}, \text{ отсюда наименьший}$$

положительный корень $\frac{\pi}{6}$, наибольший отрицательный корень $-\frac{\pi}{6}$;

$$б) \cos x \cos 3x + 0,5 = 0$$

$$\frac{1}{2} (\cos 2x + \cos 4x) + \frac{1}{2} = 0; \quad \cos 2x + (1 + \cos 4x) = 0;$$

$$\cos 2x + 2 \cos^2 2x = 0; \quad \cos 2x (2 \cos 2x + 1) = 0;$$

$$\begin{cases} \cos 2x = 0 \\ \cos 2x = \frac{1}{2} \end{cases}; \quad \begin{cases} 2x = \frac{\pi}{2} + \pi n \\ 2x = \pm \frac{\pi}{3} + 2\pi k \end{cases}; \quad \begin{cases} x = \frac{\pi}{4} + \frac{\pi n}{2} \\ x = \pm \frac{\pi}{6} + \pi k \end{cases}, \text{ отсюда наименьший}$$

положительный корень $+\frac{\pi}{4}$, наибольший отрицательный корень $-\frac{\pi}{4}$.

$$\begin{aligned}
 23.12. \text{ a) } f(x) &= \sin\left(x + \frac{\pi}{8}\right) \cos\left(x - \frac{\pi}{24}\right) = \\
 &= \frac{1}{2} \left(\sin\left(x + \frac{\pi}{8} + x - \frac{\pi}{24}\right) + \sin\left(x + \frac{\pi}{8} - x + \frac{\pi}{24}\right) \right) = \\
 &= \frac{1}{2} \sin\left(2x + \frac{\pi}{12}\right) + \frac{1}{2} \sin \frac{\pi}{6} = \frac{1}{2} \sin\left(2x + \frac{\pi}{12}\right) + \frac{1}{4}.
 \end{aligned}$$

Поскольку наибольшее и наименьшее значения функции

$y = \sin\left(2x + \frac{\pi}{12}\right)$ равны 1 и -1 соответственно, то наибольшее и

наименьшее значения функции $f(x)$ равны $\frac{3}{4}$ и $-\frac{1}{4}$ соответственно.

б) $f(x) =$

$$\begin{aligned}
 \sin\left(x + \frac{\pi}{8}\right) \sin\left(x + \frac{\pi}{3}\right) &= \frac{1}{2} \left(\cos\left(x + \frac{\pi}{3} - x + \frac{\pi}{3}\right) - \cos\left(x + \frac{\pi}{3} + x - \frac{\pi}{3}\right) \right) = \\
 &= \frac{1}{2} \left(\cos \frac{2\pi}{3} - \cos 2x \right) = -\frac{1}{4} - \frac{1}{2} \cos 2x.
 \end{aligned}$$

Поскольку наибольшее и наименьшее значения функции $y = \cos 2x$ равны 1 и -1 соответственно, то наибольшее и наименьшее значения функции $f(x)$ равны $\frac{1}{4}$ и $-\frac{3}{4}$ соответственно.

$$23.13. \cos^2(45^\circ - \alpha) - \cos^2(60^\circ + \alpha) - \cos 75^\circ \sin(75^\circ - 2\alpha) = \sin 2\alpha.$$

$$\cos^2(45^\circ - \alpha) - \cos^2(60^\circ + \alpha) - \cos 75^\circ \sin(75^\circ - 2\alpha) =$$

$$= \cos^2(45^\circ - \alpha) - \cos^2(60^\circ + \alpha) - \frac{1}{2} (\sin(75^\circ - 2\alpha + 75^\circ) +$$

$$+ \sin(75^\circ - 2\alpha - 75^\circ)) = \frac{1}{2} (1 + \cos(90^\circ - 2\alpha)) - \frac{1}{2} (1 + \cos(120^\circ +$$

$$+ 2\alpha)) - \frac{1}{2} \sin(150^\circ - 2\alpha) + \frac{1}{2} \sin 2\alpha = \sin 2\alpha - \frac{1}{2} (\cos 120^\circ \cos 2\alpha -$$

$$- \sin 120^\circ \sin 2\alpha) - \frac{1}{2} (\sin 150^\circ \cos 2\alpha - \sin 2\alpha \cos 150^\circ) =$$

$$= \sin 2\alpha - \frac{1}{2} \left(-\frac{1}{2} \cos 2\alpha - \frac{\sqrt{3}}{2} \sin 2\alpha + \frac{1}{2} \cos 2\alpha +$$

$$+ \frac{\sqrt{3}}{2} \sin 2\alpha \right) = \sin 2\alpha.$$

Глава 5. Производная

§ 24. Предел последовательности

24.1. а) $y_n = 3 - 2n$.

$$y_1 = 1, \quad y_2 = -1, \quad y_3 = -3, \quad y_4 = -5, \quad y_5 = -7.$$

б) $y_n = 2n^2 - n$.

$$y_1 = 1, \quad y_2 = 6, \quad y_3 = 15, \quad y_4 = 28, \quad y_5 = 45.$$

в) $y_n = n^3 - 1$.

$$y_1 = 0, \quad y_2 = 7, \quad y_3 = 26, \quad y_4 = 63, \quad y_5 = 124.$$

г) $\frac{3n-1}{2n}$.

$$y_1 = 1, \quad y_2 = \frac{5}{4} = 1\frac{1}{4}, \quad y_3 = \frac{8}{6} = 1\frac{1}{3},$$

$$y_4 = \frac{11}{8} = 1\frac{3}{8}, \quad y_5 = \frac{7}{5} = 1\frac{2}{5}.$$

24.2. а) $y_n = (-1)^n$.

$$y_1 = -1, \quad y_2 = 1, \quad y_3 = -1, \quad y_4 = 1, \quad y_5 = -1.$$

б) $y_n = \frac{(-2)^n}{n^2 + 1}$.

$$y_1 = -1, \quad y_2 = \frac{4}{5}, \quad y_3 = -\frac{8}{10} = -\frac{4}{5},$$

$$y_4 = \frac{16}{17}, \quad y_5 = -\frac{32}{26} = -\frac{16}{13} = -1\frac{3}{13}.$$

в) $y_n = (-1)^n \frac{1}{10^n}$.

$$y_1 = -\frac{1}{10}, \quad y_2 = \frac{1}{100}, \quad y_3 = -\frac{1}{1000},$$

$$y_4 = \frac{1}{10000}, \quad y_5 = \frac{1}{100000}.$$

г) $y_n = \frac{(-1)^n + 2}{3n - 2}$.

$$y_1 = 1, \quad y_2 = \frac{3}{4}, \quad y_3 = \frac{1}{7}, \quad y_4 = \frac{3}{10}, \quad y_5 = \frac{1}{13}.$$

24.3. а) $y_n = 3 \cos \frac{2\pi}{n}$.

$$y_1 = 3, \quad y_2 = -3, \quad y_3 = -\frac{3}{2}, \quad y_4 = 0, \quad y_5 = 3 \cos \frac{2\pi}{5}.$$

$$\text{б) } y_n = \operatorname{tg} \left((-1)^n \frac{\pi}{4} \right).$$

$$y_1 = -1, \quad y_2 = 1, \quad y_3 = -1, \quad y_4 = 1, \quad y_5 = -1.$$

$$\text{в) } y_n = 1 - \cos^2 \frac{\pi}{n}.$$

$$y_1 = 0, \quad y_2 = 1, \quad y_3 = \frac{3}{4}, \quad y_4 = \frac{1}{2}, \quad y_5 = \sin^2 \frac{\pi}{5}.$$

$$\text{г) } y_n = \sin \pi n - \cos \pi n = -\cos \pi n.$$

$$y_1 = 1, \quad y_2 = -1, \quad y_3 = 1, \quad y_4 = -1, \quad y_5 = 1.$$

$$24.4. 2^2 + 3^2 + 5^2 + 7^2 + 11^2 + 13^2 + 17^2 + 19^2 =$$

$$= 4 + 9 + 25 + 49 + 121 + 169 + 289 + 361 = 1027$$

$$24.5. \text{ а) } y_n = n - 1, n \in \mathbb{N}.$$

$$\text{б) } y_n = -n, n \in \mathbb{N}.$$

$$\text{в) } y_n = n + 4, n \in \mathbb{N}.$$

$$\text{г) } y_n = 11 - n, n \in \mathbb{N}.$$

$$24.6. \text{ а) } y_n = 5n, n \in \mathbb{N}.$$

$$\text{б) } y_n = 6n, n \in \mathbb{N}.$$

$$\text{в) } y_n = 4n, n \in \mathbb{N}.$$

$$\text{г) } y_n = 3n, n \in \mathbb{N}.$$

$$24.7. \text{ а) } y_n = 3^n, \quad n \in \mathbb{N}.$$

$$\text{б) } y_n = (n + 2)^2, \quad n \in \mathbb{N}.$$

$$\text{в) } y_n = n^3, \quad n \in \mathbb{N}.$$

$$\text{г) } y_n = n^3 + 1, \quad n \in \mathbb{N}.$$

$$24.8. \text{ а) } y_n = \frac{2}{2^n} = \frac{1}{2^{n-1}};$$

$$\text{б) } y_n = \frac{2n+1}{2n+2};$$

$$\text{в) } y_n = \frac{1}{n^3};$$

$$\text{г) } y_n = \frac{1}{(2n+1)(2n+3)}.$$

$$24.9. \text{ а) } 1; 1,4; 1,41; 1,414; 1,4142.$$

$$\text{б) } 2; 1,5; 1,42; 1,415; 1,4143.$$

$$24.10. y_n = \frac{2-n}{5n+1}.$$

$$\text{а) } y_n = 0, \quad n = 2.$$

$$\text{б) } y_n = -\frac{3}{26}, \quad n = 5.$$

$$\text{в) } y_n = -\frac{1}{6}, \quad \frac{2-n}{5n+1} = -\frac{1}{6}.$$

$$6n - 12 = 5n + 1, \quad n = 13.$$

$$\text{г) } -\frac{43}{226} = y_n. \quad \frac{2-n}{5n+1} = -\frac{43}{226}$$

$$226n - 452 = 215n + 43, \quad 11n = 495, \quad n = 45.$$

$$24.11. a_n = (2n - 1)(3n + 2) \text{ а) } a_n = 0.$$

нет, т.к. n не может быть равным $\frac{1}{2}, -\frac{2}{3}$.

$$\text{б) } a_n = 24. \quad 6n^2 + n - 2 = 24.$$

$$6n^2 + n - 26 = 0.$$

$$n = \frac{-1+25}{12} = 2, \text{ или } n = -\frac{26}{12}. \text{ (не подходит, т.к. } n \in \mathbb{N}\text{).}$$

Ответ: является.

$$\text{в) } a_n = 153. \quad 6n^2 + n - 155 = 0.$$

$$n = \frac{-1+61}{12} = 5 \quad n = -\frac{62}{12} \text{ (не подходит).}$$

Ответ: является.

$$\text{г) } a_n = -2. \quad 6n^2 + n = 0.$$

$$n(6n + 1) = 0.$$

Решения в натуральных числах нет \Rightarrow не является.

$$\text{24.12. а) } 1; \quad \frac{1}{2}; \quad \frac{1}{3}; \quad \frac{1}{4} \dots \text{ ограничена снизу.}$$

$$\text{б) } -1; \quad 2; \quad -3; \quad 4; \quad -5 \dots \text{ не ограничена снизу.}$$

$$\text{в) } \frac{1}{2}; \quad \frac{2}{3}; \quad \frac{3}{4}; \quad \frac{4}{5} \dots \text{ ограничена снизу.}$$

$$\text{г) } 5; \quad 4; \quad 3; \quad 2; \quad 1; \quad 0; \quad -1 \dots \text{ не ограничена снизу.}$$

$$\text{24.13. а) } -3; \quad -2; \quad -1; \quad 0; \quad 1 \dots \text{ не ограничена сверху.}$$

$$\text{б) } 1; \quad -1; \quad 1; \quad -2; \quad 1; \quad -3 \dots \text{ ограничена сверху.}$$

$$\text{в) } \frac{1}{2}; \quad \frac{1}{3}; \quad \frac{1}{4}; \quad \frac{1}{5} \dots \text{ ограничена сверху.}$$

$$\text{г) } \frac{1}{2}; \quad \frac{2}{3}; \quad \frac{3}{4}; \quad \frac{4}{5} \dots \text{ ограничена сверху.}$$

$$\text{24.14. а) } \frac{1}{2}; \quad \frac{1}{3}; \quad \frac{1}{4}; \dots \quad \frac{1}{n} \dots \text{ ограничена, т.к. } 0 < y_n < 1.$$

$$\text{б) } \frac{1}{2}; \quad \frac{3}{4}; \quad \frac{5}{6}; \dots \quad \frac{2n-1}{2n} \dots \text{ ограничена, т.к. } 0 < y_n < 1.$$

$$\text{в) } 5; \quad -5; \quad 5; \quad -5; \dots (-1)^{n-1} 5 \text{ ограничена, т.к. } -10 < y_n < 10.$$

$$\text{г) } -2; \quad 3; \quad -4; \quad 5; \dots (-1)^n(n+1), \dots \text{ не ограничена.}$$

$$\text{24.15. а) } y_n = 2n - 1; \quad y_{n+1} = 2n + 1; \quad y_{n+1} > y_n \Rightarrow \text{возрастающая.}$$

$$\text{б) } y_n = 5^{-n}; \quad y_{n+1} = 5^{-n-1} = \frac{5^{-n}}{5}; \quad y_{n+1} < y_n \Rightarrow \text{убывающая.}$$

$$\text{в) } y_n = n^2 + 8, \quad y_{n+1} = n^2 + 2n + 9; \quad y_{n+1} > y_n \Rightarrow \text{возрастающая.}$$

$$\text{г) } y_n = \frac{2}{3n+1}, \quad y_{n+1} = \frac{2}{3n+4}, \quad y_{n+1} < y_n \Rightarrow \text{убывающая.}$$

24.16.

$$\text{а) } x_n = (-2)^n \quad x_1 = -2, \quad x_2 = 4, \quad x_3 = -8$$

\Rightarrow последовательность не является монотонной.

$$6) y_n = \cos \frac{\pi}{n+5}$$

$$y_1 = \cos \frac{\pi}{6}, \quad y_2 = \cos \frac{\pi}{7}, \quad y_3 = \cos \frac{\pi}{8}.$$

$$y_1 < y_2 < y_3 \dots \Rightarrow \text{возрастающая.}$$

$$B) y_n = n^3 - 5$$

$$y_1 = -4, \quad y_2 = 3, \quad y_3 = 22. \Rightarrow \text{возрастающая.}$$

$$r) y_n = \sqrt{n+8}$$

$$y_1 = 3, \quad y_2 = \sqrt{10}, \quad y_3 = \sqrt{11} \Rightarrow \text{возрастающая.}$$

$$24.17. a) y_n = 2^n; \quad б) y_n = 2^n;$$

$$B) y_n = \left(\frac{1}{2}\right)^n; \quad r) y_n = -n.$$

$$24.18. a) \lim_{n \rightarrow \infty} \frac{5}{n^2} = 0.$$

$$б) \lim_{n \rightarrow \infty} \left(-\frac{17}{n^3}\right) = 0.$$

$$B) \lim_{n \rightarrow \infty} \left(-\frac{15}{n^2}\right) = 0.$$

$$r) \lim_{n \rightarrow \infty} \frac{3}{\sqrt{n}} = 0.$$

$$24.19. a) \lim_{n \rightarrow \infty} \left(\frac{7}{n} + \frac{8}{\sqrt{n}} + \frac{9}{n^3}\right) = 0 + 0 + 0 = 0.$$

$$б) \lim_{n \rightarrow \infty} \left(6 - \frac{7}{n^2} - \frac{3}{n} - \frac{3}{\sqrt{n}}\right) = 6 - 0 - 0 - 0 = 6.$$

$$B) \lim_{n \rightarrow \infty} \left(\frac{3}{n} + \frac{7}{n^2} - \frac{5}{n^3} + \frac{13}{n^4}\right) = 0 + 0 - 0 + 0 = 0.$$

$$r) \lim_{n \rightarrow \infty} \left(\frac{1}{n} + \frac{3}{\sqrt{n}} - 4 + \frac{7}{n^2}\right) = 0 + 0 - 4 + 0 = -4.$$

$$24.20. a) \lim_{n \rightarrow \infty} \frac{5n+3}{n+1} = \lim_{n \rightarrow \infty} \frac{5 + \frac{3}{n}}{1 + \frac{1}{n}} = 5. \quad б) \lim_{n \rightarrow \infty} \frac{7n-5}{n+2} = \lim_{n \rightarrow \infty} \frac{7 - \frac{5}{n}}{1 + \frac{2}{n}} = 7.$$

$$B) \lim_{n \rightarrow \infty} \frac{3n+1}{n+2} = \lim_{n \rightarrow \infty} \frac{3 + \frac{1}{n}}{1 + \frac{2}{n}} = 3.$$

$$r) \lim_{n \rightarrow \infty} \frac{2n+1}{3n-1} = \lim_{n \rightarrow \infty} \frac{2 + \frac{1}{n}}{3 - \frac{1}{n}} = \frac{2}{3}.$$

$$24.21. a) \lim_{n \rightarrow \infty} \frac{5}{2^n} = 0.$$

$$б) \lim_{n \rightarrow \infty} \frac{1}{2} \cdot 5^{-n} = 0.$$

$$B) \lim_{n \rightarrow \infty} 7 \cdot 3^{-n} = 0.$$

$$r) \lim_{n \rightarrow \infty} \frac{4}{3^{n+1}} = 0.$$

$$24.22. \text{ a) } \lim_{n \rightarrow \infty} \frac{2n^2 - 1}{n^2} = \lim_{n \rightarrow \infty} \left(2 - \frac{1}{n^2} \right) = 2.$$

$$\text{б) } \lim_{n \rightarrow \infty} \frac{(1 + 2n + n^2)}{n^2} = \lim_{n \rightarrow \infty} \left(\frac{1}{n^2} + \frac{2}{n} + 1 \right) = 1.$$

$$\text{в) } \lim_{n \rightarrow \infty} \frac{3 - n^2}{n^2} = \lim_{n \rightarrow \infty} \left(\frac{3}{n^2} - 1 \right) = -1.$$

$$\text{г) } \lim_{n \rightarrow \infty} \frac{3n - 4 - 2n^2}{n^2} = \lim_{n \rightarrow \infty} \left(\frac{3}{n} - \frac{4}{n^2} - 2 \right) = -2.$$

§ 25. Сумма бесконечной геометрической прогрессии

$$25.1. \text{ a) } b_1 = 3; q = \frac{1}{3}. S_n = \frac{3}{1 - \frac{1}{3}} = 4\frac{1}{2}.$$

$$\text{б) } b_1 = -5; q = -0,1. S_n = \frac{-5}{1 + 0,1} = -\frac{50}{11} = -4\frac{6}{11}.$$

$$\text{в) } b_1 = -1; q = 0,2. S_n = \frac{-1}{0,8} = -\frac{5}{4} = -1\frac{1}{4}.$$

$$\text{г) } b_1 = 2; q = -\frac{1}{3}. S_n = \frac{2}{1 + \frac{1}{3}} = \frac{6}{4} = \frac{3}{2}.$$

25.2. а) 32, 16, 8, 4...

$$b_1 = 32; q = \frac{1}{2}. S_n = \frac{32}{1 - \frac{1}{2}} = 64.$$

б) 24, -8, $\frac{8}{3}$, $-\frac{8}{9}$...

$$b_1 = 24; q = -\frac{1}{3}. S_n = \frac{24}{1 + \frac{1}{3}} = \frac{24 \cdot 3}{4} = 18.$$

в) 27, 9, 3, 1, $\frac{1}{3}$...

$$b_1 = 27; q = \frac{1}{3}. S_n = \frac{27}{\frac{2}{3}} = \frac{81}{2} = 40,5.$$

$$r) 18, -6, 2, -\frac{1}{3} \dots$$

$$b_1 = 18; q = -\frac{1}{3}. S_n = \frac{18}{1 + \frac{1}{3}} = \frac{27}{2} = 13,5.$$

$$25.3. a) 2 + 1 + \frac{1}{2} + \frac{1}{4} \dots$$

$$b_1 = 2 \quad q = \frac{1}{2}. S_n = \frac{2}{1 - \frac{1}{2}} = 4.$$

$$b) 49 + 7 + 1 + \frac{1}{7} \dots$$

$$b_1 = 49 \quad q = \frac{1}{7}. S_n = \frac{49}{1 - \frac{1}{7}} = 57\frac{1}{6}.$$

$$b) \frac{3}{2} - 1 + \frac{2}{3} - \frac{4}{9} \dots$$

$$b_1 = \frac{3}{2} \quad q = -\frac{2}{3}. S_n = \frac{\frac{3}{2}}{1 + \frac{2}{3}} = \frac{3}{2} \cdot \frac{3}{5} = \frac{9}{10}.$$

$$r) 125 + 25 + 5 + 1 \dots$$

$$b_1 = 125 \quad q = \frac{1}{5}. S_n = \frac{125}{\frac{4}{5}} = \frac{625}{4} = 156,25.$$

$$25.4. a) -6 + \frac{2}{3} - \frac{2}{27} + \frac{2}{243} \dots$$

$$b_1 = -6 \quad q = -\frac{1}{9}. S_n = \frac{-6}{1 + \frac{1}{9}} = -\frac{54}{10} = -\frac{27}{5}.$$

$$b) 3 + \sqrt{3} + 1 + \frac{1}{\sqrt{3}} \dots$$

$$b_1 = 3 \quad q = \frac{1}{\sqrt{3}}. S_n = \frac{3}{1 - \frac{1}{\sqrt{3}}} = \frac{3\sqrt{3}}{\sqrt{3}-1} = \frac{3\sqrt{3}(\sqrt{3}+1)}{2}.$$

$$b) 49 - 14 + 4 - \frac{8}{7} \dots$$

$$b_1 = 49 \quad q = -\frac{2}{7}. S_n = \frac{49}{1 + \frac{2}{7}} = \frac{343}{9} = 38\frac{1}{9}.$$

$$r) 4 + 2\sqrt{2} + 2 + \sqrt{2} \dots$$

$$b_1 = 4 \quad q = \frac{1}{\sqrt{2}} \quad S_n = \frac{4}{1 - \frac{1}{\sqrt{2}}} = \frac{4\sqrt{2}}{\sqrt{2} - 1} = 4\sqrt{2}(\sqrt{2} + 1).$$

$$25.5. a) b_1 = -2; b_2 = 1.$$

$$q = -\frac{1}{2} \quad S_n = \frac{-2}{1 + \frac{1}{2}} = -\frac{4}{3} = -1\frac{1}{3}.$$

$$6) b_1 = 3; b_2 = \frac{1}{3}.$$

$$q = \frac{1}{9} \quad S_n = \frac{3}{1 - \frac{1}{9}} = \frac{27}{8} = 3\frac{3}{8}.$$

$$b) b_1 = 7; b_2 = -1.$$

$$q = -\frac{1}{7} \quad S_n = \frac{7}{1 + \frac{1}{7}} = \frac{49}{8} = 6\frac{1}{8}.$$

$$r) b_1 = -20; b_2 = 4.$$

$$q = -\frac{1}{5} \quad S_n = \frac{-20}{1 + \frac{1}{5}} = -\frac{100}{6} = -\frac{50}{3}.$$

$$25.6. a) S_n = 2; b_1 = 3.$$

$$S_n = \frac{b_1}{1 - q}; 1 - q = \frac{b_1}{S_n} \quad q = 1 - \frac{b_1}{S_n} = 1 - \frac{3}{2} = -\frac{1}{2}.$$

$$6) S_n = -10; b_1 = -5.$$

$$q = 1 - \frac{5}{-10} = \frac{1}{2}.$$

$$b) S_n = -\frac{9}{4}; b_1 = -3.$$

$$q = 1 - \frac{3}{-\frac{9}{4}} = 1 - \frac{4}{3} = -\frac{1}{3}.$$

$$r) S_n = 1,5; b_1 = 2.$$

$$q = 1 - \frac{2}{1,5} = 1 - \frac{4}{3} = -\frac{1}{3}.$$

$$25.7. a) S = 10, q = \frac{1}{10}.$$

$$S = \frac{b_1}{1 - q}, b_1 = S(1 - q) = 10 \cdot \frac{9}{10} = 9.$$

$$6) S = -3, q = -\frac{1}{3}, \quad b_1 = -3 \cdot \left(1 + \frac{1}{3}\right) = -4.$$

$$B) S = 6, q = -\frac{1}{2}, \quad b_1 = 6 \cdot \frac{3}{2} = 9.$$

$$r) S = -21, \quad q = \frac{1}{7}, \quad b_1 = -21 \cdot \left(1 - \frac{1}{7}\right) = -18.$$

$$25.8. a) S = 15, \quad q = -\frac{1}{3}, \quad n = 3.$$

$$b_1 = 15 \cdot \frac{4}{3} = 20, \quad b_3 = 20 \cdot \left(-\frac{1}{3}\right)^2 = \frac{20}{9} = 2\frac{2}{9}.$$

$$6) S = -20, \quad b_1 = -16, \quad n = 4, \quad q = 1 - \frac{16}{20} = \frac{1}{5}.$$

$$b_4 = -16 \cdot \left(\frac{1}{5}\right)^3 = -\frac{16}{125}.$$

$$B) S = 20, \quad b_1 = 22, \quad n = 4, \quad q = 1 - \frac{22}{20} = -\frac{1}{10}.$$

$$b_4 = 22 \cdot \left(-\frac{1}{10}\right)^3 = -\frac{11}{500}.$$

$$r) S = 21, \quad q = \frac{2}{3}, \quad n = 3, \quad b_1 = 21 \cdot \left(1 - \frac{2}{3}\right) = 7.$$

$$b_3 = 7 \cdot \left(\frac{2}{3}\right)^2 = \frac{28}{9} = 3\frac{1}{9}.$$

25.9.

$$a) b_n = \frac{25}{3^n}, \quad b_1 = \frac{25}{3}, \quad b_2 = \frac{25}{9}, \quad q = \frac{1}{3}.$$

$$S_n = \frac{25/3}{2/3} = 12,5.$$

$$6) b_n = (-1)^n \frac{13}{2^{n-1}}, \quad b_1 = -13, \quad b_2 = \frac{13}{2}, \quad q = -\frac{1}{2}.$$

$$S_n = \frac{-13}{3/2} = -\frac{26}{3} = -8\frac{2}{3}.$$

$$B) b_n = \frac{45}{3^n}, \quad b_1 = \frac{45}{3}, \quad b_2 = \frac{45}{9}, \quad q = \frac{1}{3}.$$

$$S_n = \frac{45/3}{2/3} = \frac{45}{2} = 22,5.$$

$$r) b_n = (-1)^n \frac{7}{6^{n-2}} \quad b_1 = -42 \quad b_2 = 7 \quad q = -\frac{1}{6}$$

$$S_n = \frac{-42}{1 + 1/6} = -36.$$

$$25.10. \begin{cases} b_1 + b_3 = 29 \\ b_2 + b_4 = 11,6 \end{cases} \quad \begin{cases} b_1 + b_1 q^2 = 29 \\ b_1 q + b_1 q^3 = 11,6 \end{cases}$$

$$\begin{cases} b_1(1 + q^2) = 29 \\ b_1 q(1 + q^2) = 11,6 \end{cases} \quad q = \frac{2}{5}$$

$$b_1 = \frac{29}{1 + \frac{4}{25}} = 25. \quad S_n = \frac{25}{1 - \frac{2}{5}} = \frac{25 \cdot 5}{3} = 41 \frac{2}{3}$$

Ответ: $S_n = 41 \frac{2}{3}$.

$$25.11. S_n = 24 \quad S_3 = 21.$$

$$\begin{cases} \frac{b_1}{1-q} = 24 \\ \frac{b_1(q^3-1)}{q-1} = 21 \end{cases} \quad \begin{cases} q^3 - 1 = -\frac{7}{8} \\ q^3 = \frac{1}{8} \\ q = \frac{1}{2} \end{cases} \quad \begin{cases} \frac{b_1}{1/2} = 24 \\ q = \frac{1}{2} \end{cases} \quad b_1 = 12$$

Ответ: $b_1 = 12, q = \frac{1}{2}$.

$$25.12. \begin{cases} S_n = 18 \\ b_1^2 + b_1^2 q^2 + b_1^2 q^4 \dots = 162 \end{cases}$$

$$\begin{cases} \frac{b_1}{q-1} = -18 \\ \frac{b_1^2}{1-q^2} = 162 \end{cases} \quad \begin{cases} \frac{b_1}{1-q} = 18 \\ \frac{b_1^2}{1-q^2} = 162 \end{cases} \quad \begin{cases} b_1 = 18(1-q) \\ 324(1-2q+q^2) = 162 - 162q^2 \end{cases}$$

$$2q^2 - 4q + 2 = 1 - q^2 \quad 3q^2 - 4q + 1 = 0$$

$$q = \frac{2+1}{3} = 1 \quad \text{— но такого быть не может.}$$

$$q = \frac{1}{3}, \quad b_1 = 12.$$

$$25.13. a) \sin x + \sin^2 x + \sin^3 x + \dots = \frac{\sin x}{1 - \sin x}$$

$$б) \cos x - \cos^2 x + \cos^3 x + \dots = \frac{\cos x}{1 + \cos x}.$$

$$в) \cos^2 x + \cos^4 x + \cos^6 x + \dots = \frac{\cos^2 x}{1 - \cos^2 x} = \operatorname{ctg}^2 x.$$

$$г) 1 - \sin^3 x + \sin^6 x - \sin^9 x + \dots = \frac{1}{1 + \sin^3 x}.$$

$$25.14. а) x + x^2 + x^3 + \dots = 4.$$

$$\frac{x}{1-x} = 4; \quad x = 4 - 4x; \quad x = \frac{4}{5}.$$

$$б) 2x - 4x^2 + 8x^3 - 16x^4 + \dots = \frac{3}{8}.$$

$$\frac{2x}{1+2x} = \frac{3}{8}; \quad 2x = \frac{3}{8} + \frac{3}{4}x; \quad 10x = 3; \quad x = \frac{3}{10}.$$

$$25.15. а) 0,(15) = 0,15 + \frac{0,(15)}{100} \Rightarrow 0,(15) = \frac{0,15}{0,99} = \frac{5}{33}$$

$$б) 0,1(2) = 0,1 + \frac{0,1(2) + 0,1}{10} \Rightarrow 0,1(2) = \frac{0,11}{0,9} = \frac{11}{90}$$

$$в) 0,(18) = 0,18 + \frac{0,(18)}{100} \Rightarrow 0,(18) = \frac{0,18}{0,99} = \frac{2}{11}$$

$$г) 0,2(34) = 0,23 + \frac{0,2(34) + 0,2}{100} \Rightarrow 0,2(34) = \frac{0,232}{0,99} = \frac{116}{495}$$

§ 26. Предел функции

26.1. а) при $x \rightarrow +\infty$ рис. 23, 25 учебника.

б) при $x \rightarrow -\infty$ рис. 24, 25 учебника.

в) при $x \rightarrow \infty$ рис. 25 учебника.

26.2. а) $y = 3$ – горизонт. асимптота на луче $(-\infty; 4]$

$\lim_{x \rightarrow -\infty} f(x) = 3$; $\lim_{x \rightarrow +\infty} f(x)$, $\lim_{x \rightarrow \infty} f(x)$ не существуют

б) $y = -2$ – горизонт. асимптота на луче $[-6; +\infty)$

$\lim_{x \rightarrow \infty} f(x)$, $\lim_{x \rightarrow -\infty} f(x)$ не существуют; $\lim_{x \rightarrow +\infty} f(x) = -2$.

в) $y = -5$ – горизонт. асимптота на луче $(-\infty; 3]$

$\lim_{x \rightarrow -\infty} f(x) = -5$; $\lim_{x \rightarrow +\infty} f(x)$, $\lim_{x \rightarrow \infty} f(x)$ не существуют

г) $y = 5$ – горизонт. асимптота на луче $[4; +\infty)$

$\lim_{x \rightarrow \infty} f(x)$, $\lim_{x \rightarrow -\infty} f(x)$ не существуют; $\lim_{x \rightarrow +\infty} f(x) = 5$.

26.3.

a) $\lim_{x \rightarrow \infty} f(x) = 5.$

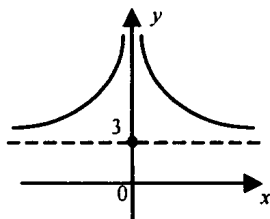

б) $\lim_{x \rightarrow \infty} f(x) = -2.$

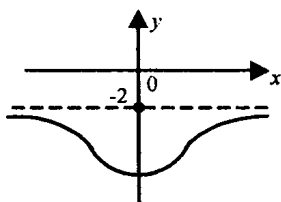

в) $\lim_{x \rightarrow \infty} f(x) = -5.$

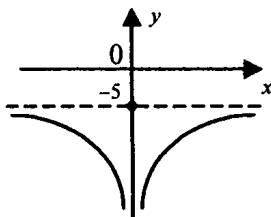

г) $\lim_{x \rightarrow \infty} f(x) = 0.$

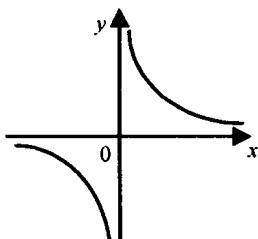

26.4.

a) $\lim_{x \rightarrow +\infty} f(x) = 5, \quad f(x) > 0, \quad x \in \mathfrak{R}.$

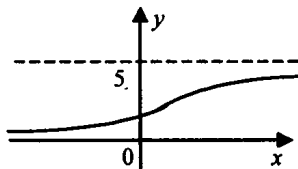

б) $\lim_{x \rightarrow -\infty} f(x) = 0, \quad f(x) < 0, \quad x \in \mathfrak{R}.$

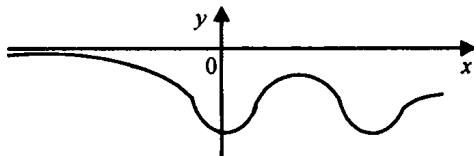

26.5. а) $\lim_{x \rightarrow +\infty} h(x) = 4$ и функция возрастает.

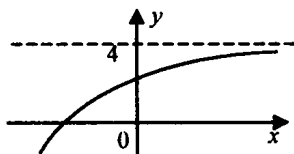

б) $\lim_{x \rightarrow -\infty} h(x) = 1$ и функция ограничена сверху.

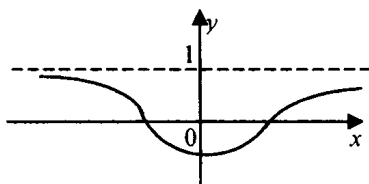

в) $\lim_{x \rightarrow -\infty} h(x) = 5$ и функция убывает.

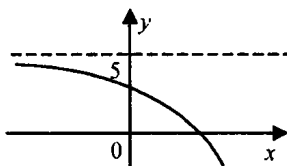

г) $\lim_{x \rightarrow \infty} h(x) = 1$ и функция ограничена

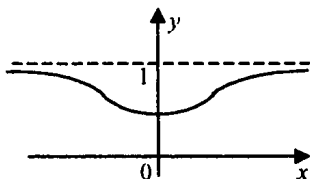

26.6. $\lim_{x \rightarrow +\infty} f(x) = -3$.

а) $\lim_{x \rightarrow \infty} f(x) = -18$. б) $\lim_{x \rightarrow -\infty} \frac{f(x)}{3} = -1$.

в) $\lim_{x \rightarrow -\infty} 8f(x) = -24$. г) $\lim_{x \rightarrow \infty} 0,4f(x) = -\frac{6}{5}$.

26.7. $\lim_{x \rightarrow \infty} f(x) = 2$. $\lim_{x \rightarrow \infty} g(x) = -3$. $\lim_{x \rightarrow \infty} h(x) = 9$.

а) $\lim_{x \rightarrow \infty} (f(x) + g(x)) = \lim_{x \rightarrow \infty} f(x) + \lim_{x \rightarrow \infty} g(x) = 2 - 3 = -1$.

б) $\lim_{x \rightarrow \infty} (g(x) \cdot f(x)) = \lim_{x \rightarrow \infty} g(x) \lim_{x \rightarrow \infty} f(x) = -6$

в) $\lim_{x \rightarrow \infty} \frac{f(x)g(x)}{h(x)} = \frac{\lim_{x \rightarrow \infty} (f(x)g(x))}{\lim_{x \rightarrow \infty} h(x)} = \frac{2}{3}$

г) $\lim_{x \rightarrow \infty} \frac{2h(x)}{3g(x)} = \frac{2 \lim_{x \rightarrow \infty} h(x)}{3 \lim_{x \rightarrow \infty} g(x)} = -2$

$$26.8. \text{ a) } \lim_{x \rightarrow \infty} \left(\frac{1}{x^2} + \frac{3}{x^3} \right) = 0.$$

$$\text{б) } \lim_{x \rightarrow \infty} \left(\frac{5}{x^3} + 1 \right) \left(-\frac{8}{x^2} - 2 \right) = 1 \cdot (-2) = -2.$$

$$\text{в) } \lim_{x \rightarrow \infty} \left(\frac{2}{x^2} + \frac{8}{x^3} \right) = 0$$

$$\text{г) } \lim_{x \rightarrow \infty} \left(\frac{7}{x^6} - 2 \right) \left(-\frac{6}{x^{10}} - 3 \right) = 6.$$

$$26.9. \text{ a) } \lim_{x \rightarrow \infty} \frac{x+1}{x-2} = 1.$$

$$\text{б) } \lim_{x \rightarrow \infty} \frac{3x-4}{2x+7} = \lim_{x \rightarrow \infty} \frac{3 - \frac{4}{x}}{2 + \frac{7}{x}} = \frac{3}{2}.$$

$$\text{в) } \lim_{x \rightarrow \infty} \frac{x-4}{x+3} = 1.$$

$$\text{г) } \lim_{x \rightarrow \infty} \frac{7x+9}{6x-1} = \frac{7}{6} = 1\frac{1}{6}.$$

$$26.10. \text{ a) } \lim_{x \rightarrow \infty} \frac{4x^2+9}{x^2+2} = \lim_{x \rightarrow \infty} \frac{4 + \frac{9}{x^2}}{1 + \frac{2}{x^2}} = 4.$$

$$\text{б) } \lim_{x \rightarrow \infty} \frac{3x-1}{x^2+7x+5} = \lim_{x \rightarrow \infty} \frac{\frac{3}{x} - \frac{1}{x^2}}{1 + \frac{7}{x} + \frac{5}{x^2}} = 0.$$

$$\text{в) } \lim_{x \rightarrow \infty} \frac{-2x-1}{3x^2-4x+1} = \lim_{x \rightarrow \infty} \frac{-\frac{2}{x} - \frac{1}{x^2}}{3 - \frac{4}{x} + \frac{1}{x^2}} = 0.$$

$$\text{г) } \lim_{x \rightarrow \infty} \frac{10x^2+4x-3}{5x^2+2x+1} = \lim_{x \rightarrow \infty} \frac{10 + \frac{4}{x} - \frac{3}{x^2}}{5 + \frac{2}{x} + \frac{1}{x^2}} = 2.$$

26.11. при $x \rightarrow 3$

$f(x)$ на рис. 25 имеет предел и он равен 4.

$f(x)$ на рис. 23 имеет предел и он равен 3.

$f(x)$ на рис. 24 имеет предел и он равен 4.

$f(x)$ на рис. 30 имеет предел и он равен 0.

$$26.12. \text{ a) } \lim_{x \rightarrow -1} g(x) = 2.$$

$$\text{б) } \lim_{x \rightarrow 2} g(x) = -3.$$

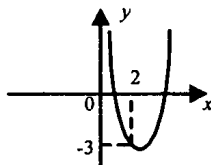
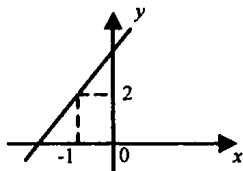

в) $\lim_{x \rightarrow -7} g(x) = -4$.

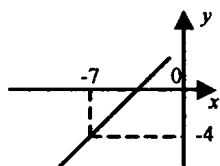

г) $\lim_{x \rightarrow 5} g(x) = 3,5$.

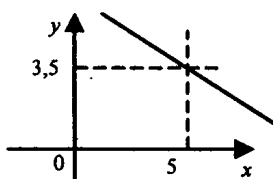

26.13.

а) $\lim_{x \rightarrow -\infty} f(x) = 0$.

б) $\lim_{x \rightarrow 0} f(x) = 4$.

в) $\lim_{x \rightarrow 3} f(x) = 9$.

г) $\lim_{x \rightarrow \infty} f(x)$ не существует.

26.14.

а) $\lim_{x \rightarrow +\infty} f(x) = 4$ и $\lim_{x \rightarrow -\infty} f(x) = 0$

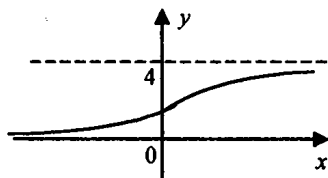

б) $\lim_{x \rightarrow +\infty} f(x) = 10$ и $\lim_{x \rightarrow -\infty} f(x) = -2$

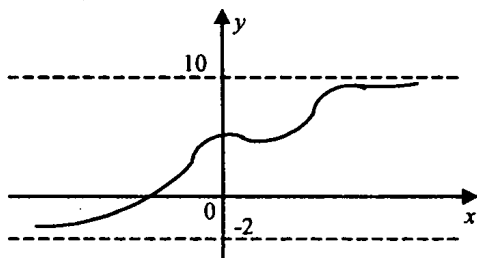

в) $\lim_{x \rightarrow +\infty} f(x) = -2$ и $\lim_{x \rightarrow -\infty} f(x) = 1$

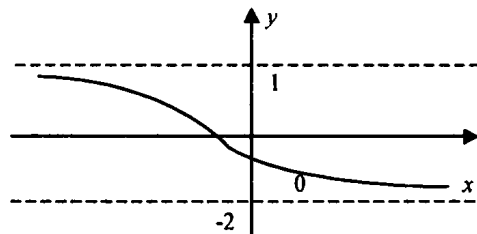

г) $\lim_{x \rightarrow +\infty} f(x) = 3$ и $\lim_{x \rightarrow -\infty} f(x) = -4$

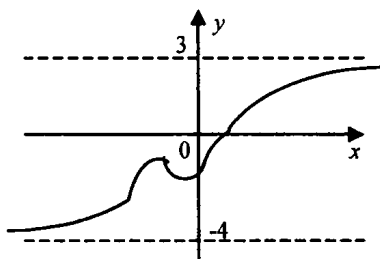

26.15. а) $\lim_{x \rightarrow 2} f(x) = 3$ и $f(2) = 3$

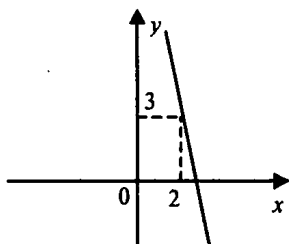

б) $\lim_{x \rightarrow -6} f(x) = 4$ и $\lim_{x \rightarrow -\infty} f(x) = 0$

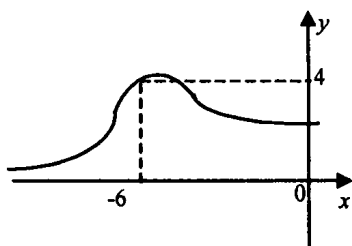

в) $\lim_{x \rightarrow -1} f(x) = 4$ и $f(-1)$ не существует

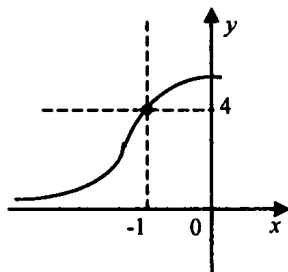

$$\text{г) } \lim_{x \rightarrow 3} f(x) = -1 \quad \text{и} \quad \lim_{x \rightarrow +\infty} f(x) = -5$$

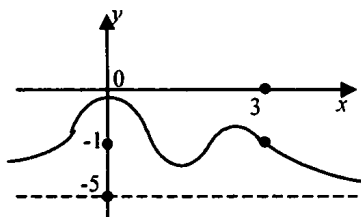

$$26.16. \text{ а) } \lim_{x \rightarrow 1} (x^2 - 3x + 5) = 1 - 3 + 5 = 3.$$

$$\text{б) } \lim_{x \rightarrow \frac{1}{2}} \left(\frac{2x+3}{4x+2} \right) = \frac{1+3}{2+2} = 1.$$

$$\text{в) } \lim_{x \rightarrow -1} (x^2 + 6x - 8) = 1 - 6 - 8 = -13.$$

$$\text{г) } \lim_{x \rightarrow -\frac{1}{3}} \frac{7x-14}{21x+2} = \frac{-\frac{7}{3}-14}{-7+2} = \frac{49}{15}.$$

$$26.17. \text{ а) } \lim_{x \rightarrow 5} \sqrt{x+4} = \sqrt{9} = 3.$$

$$\text{б) } \lim_{x \rightarrow 1} \frac{3+4x}{2x^2+6x-3} = \frac{3+4}{2+6-3} = \frac{7}{5} = 1\frac{2}{5}.$$

$$\text{в) } \lim_{x \rightarrow 0} \frac{4x+7}{x^2-5x+3} = \frac{7}{3} = 2\frac{1}{3}.$$

$$\text{г) } \lim_{x \rightarrow -1} \frac{5-2x}{3x^2-2x+4} = \frac{5+2}{3+2+4} = \frac{7}{9}.$$

$$26.18. \text{ а) } \lim_{x \rightarrow 0} \frac{x^2}{x^2-x} = \lim_{x \rightarrow 0} \frac{x}{x-1} = 0.$$

$$\text{б) } \lim_{x \rightarrow -2} \frac{x^2-4}{2+x} = \lim_{x \rightarrow -2} (x-2) = -4.$$

$$\text{в) } \lim_{x \rightarrow 5} \frac{x^2-25}{x-5} = \lim_{x \rightarrow 5} (x+5) = 10.$$

$$\text{г) } \lim_{x \rightarrow -3} \frac{3+x}{x^2-9} = \lim_{x \rightarrow -3} \frac{1}{x-3} = -\frac{1}{6}.$$

$$26.19. \text{ а) } \lim_{x \rightarrow \frac{\pi}{2}} \frac{\sin 3x + \sin x}{\cos 3x + \cos x} = \lim_{x \rightarrow \frac{\pi}{2}} \frac{\sin 2x \cos x}{\cos 2x \cos x} = \lim_{x \rightarrow \frac{\pi}{2}} \operatorname{tg} 2x = 0.$$

$$\text{б) } \lim_{x \rightarrow 0} \frac{\cos 5x - \cos 3x}{\sin 5x + \sin 3x} = \lim_{x \rightarrow 0} \left(-\frac{\sin 4x \sin x}{\sin 4x \cos x} \right) = 0.$$

$$26.20. y = 2x - 3 \quad x_0 = 3. \quad y(x_0) = 3$$

$$a) x_1 = 3,2. \quad y(x_1) = 3,4. \quad \Delta y = 0,4.$$

$$б) x_1 = 2,9. \quad y(x_1) = 2,8. \quad \Delta y = -0,2.$$

$$в) x_1 = 3,5. \quad y(x_1) = 4. \quad \Delta y = 1.$$

$$г) x_1 = 2,5. \quad y(x_1) = 2. \quad \Delta y = -1.$$

$$26.21. y = x^2 + 2x \quad x_0 = -2. \quad y(x_0) = 0.$$

$$a) x_1 = -1,9. \quad y(x_1) = -0,19. \quad \Delta y = -0,19.$$

$$б) x_1 = -2,1. \quad y(x_1) = 0,21. \quad \Delta y = 0,21.$$

$$в) x_1 = -1,5. \quad y(x_1) = -0,75. \quad \Delta y = -0,75.$$

$$г) x_1 = -2,5. \quad y(x_1) = 1,25. \quad \Delta y = 1,25.$$

$$26.22. y = \sqrt{x} \quad x_0 = 1.$$

$$a) \Delta x = 0,44. \quad y(x + \Delta x) - y(x) = 1,2 - 1 = 0,2.$$

$$б) \Delta x = -0,19. \quad y(x + \Delta x) - y(x) = 0,9 - 1 = -0,1.$$

$$в) \Delta x = 0,21. \quad y(x + \Delta x) - y(x) = 1,1 - 1 = 0,1.$$

$$г) \Delta x = 0,1025. \quad y(x + \Delta x) - y(x) = 1,05 - 1 = 0,05.$$

$$26.23. a) f(x_1) - f(x_0) = 1,4 - 2 = -0,6 \quad \Delta x = x_1 - x_0 = -2.$$

$$б) f(x_1) - f(x_0) = 1 - 6 = -5 \quad \Delta x = x_1 - x_0 = 2.$$

$$26.24. a) f(x) = 3x + 5. \quad f(x + \Delta x) = 3x + 3\Delta x + 5. \quad f(x + \Delta x) - f(x) = 3\Delta x.$$

$$б) f(x) = -x^2. \quad f(x + \Delta x) = -x^2 - 2x\Delta x - (\Delta x)^2.$$

$$f(x + \Delta x) - f(x) = -2x\Delta x - (\Delta x)^2.$$

$$в) f(x) = 4 - 2x. \quad f(x + \Delta x) = 4 - 2x - 2\Delta x. \quad f(x + \Delta x) - f(x) = -2\Delta x.$$

$$г) f(x) = 2x^2. \quad f(x + \Delta x) = 2x^2 + 4x\Delta x + 2(\Delta x)^2. \quad f(x + \Delta x) - f(x) = 4x\Delta x + 2(\Delta x)^2.$$

$$26.25. a) f(x) = ax^2, \quad f(x + \Delta x) = ax^2 + 2a\Delta x \cdot x + a \cdot \Delta x^2,$$

$$f(x + \Delta x) - f(x) = 2a\Delta x \cdot x + a \cdot (\Delta x)^2;$$

$$б) f(x) = \frac{1}{x}, \quad f(x + \Delta x) = \frac{1}{x + \Delta x},$$

$$f(x + \Delta x) - f(x) = \frac{x - x - \Delta x}{(x + \Delta x)x} = -\frac{\Delta x}{x^2 + x\Delta x}.$$

§ 27. Определение производной

$$27.1. s(t) = 2t + 1. \quad t_1 = 2.$$

$$a) t_2 = 3.$$

$$S(3) - S(2) = 7 - 5 = 2 = \Delta S. \quad \Delta t = 1.$$

$$V_{cp} = \frac{\Delta S}{\Delta t} = 2 \text{ (м/с)}.$$

$$б) t_2 = 2,5.$$

$$S(2,5) - S(2) = 6 - 5 = 1.$$

$$\Delta t = 0,5.$$

$$\frac{\Delta S}{\Delta t} = V_{cp} = \frac{1}{0,5} = 2 \text{ (м/с)}.$$

$$в) t_2 = 2,1.$$

$$S(2,1) - S(2) = 0,2. \quad \Delta t = 0,1.$$

$$\frac{\Delta S}{\Delta t} = \frac{0,2}{0,1} = 2 \text{ (м/с)}.$$

$$\text{r) } t_2 = 2,05.$$

$$S(2,05) - S(2) = 0,1. \quad \Delta t = 0,05. \quad \frac{\Delta S}{\Delta t} = \frac{0,1}{0,05} = 2 \text{ (м/с)}.$$

$$27.2. s(t) = t^2. \quad t_1 = 0.$$

$$\text{a) } t_2 = 0,1. \quad S(0,1) - S(0) = 0,01. \quad \frac{\Delta S}{\Delta t} = 0,1 \text{ (м/с)}.$$

$$\text{б) } t_2 = 0,01. \quad S(0,01) - S(0) = 0,0001. \quad \frac{\Delta S}{\Delta t} = 0,01 \text{ (м/с)}.$$

$$\text{в) } t_2 = 0,2. \quad S(0,2) - S(0) = 0,04. \quad \frac{\Delta S}{\Delta t} = 0,2 \text{ (м/с)}.$$

$$\text{г) } t_2 = 0,02. \quad S(0,02) - S(0) = 0,0004. \quad \frac{\Delta S}{\Delta t} = 0,02 \text{ (м/с)}.$$

$$27.3. \text{ a) } S(t) = 4t + 1. \quad V_{\text{МГНОВ}} = 4 \text{ (м/с)}.$$

$$\text{б) } S(t) = 6t - 2. \quad V_{\text{МГНОВ}} = 6 \text{ (м/с)}.$$

$$\text{в) } S(t) = 3t + 2. \quad V_{\text{МГНОВ}} = 3 \text{ (м/с)}.$$

$$\text{г) } S(t) = 5t - 1. \quad V_{\text{МГНОВ}} = 5 \text{ (м/с)}.$$

$$27.4. \text{ a) } f(x_1) = \text{tg } 60^\circ = \sqrt{3}. \quad f(x_2) = \text{tg } 45^\circ = 1.$$

$$\text{б) } \rho'(x_1) = 30^\circ = \frac{\sqrt{3}}{3}; \quad f(x_2) = \text{tg } 0^\circ = 0.$$

$$\text{в) } f(x_1) = 0. \quad f(x_2) = -\frac{\sqrt{3}}{3}.$$

$$\text{г) } f(x_1) = 0. \quad f(x_2) = 0.$$

$$27.5. \text{ a) } y = 9,5x - 3. \quad f(x) = 9,5. \quad \text{б) } y = -16x + 3. \quad f(x) = -16.$$

$$\text{в) } y = 6,7x - 13. \quad f(x) = 6,7. \quad \text{г) } y = -9x + 4. \quad f(x) = -9.$$

$$27.6. \text{ a) } f(x) = x^2. \quad x_0 = 2. \quad f(x_0) = 2x_0 = 4. \quad \text{б) } f(x) = x^2. \quad x_0 = -1. \quad f(x_0) = -2.$$

$$\text{в) } f(x) = x^2. \quad x_0 = -2. \quad f(x_0) = -4. \quad \text{г) } f(x) = x^2. \quad x_0 = 9. \quad f(x_0) = 18.$$

$$27.7. \text{ a) } f(x) = \frac{1}{x}. \quad x_0 = 2. \quad f(x_0) = -\frac{1}{4}. \quad f'(x_0) = -\frac{1}{x_0^2}.$$

$$\text{б) } f(x) = \frac{1}{x}. \quad x_0 = -1. \quad f(x_0) = -1.$$

$$\text{в) } f(x) = \frac{1}{x}. \quad x_0 = 5. \quad f(x_0) = -\frac{1}{25}.$$

$$\text{г) } f(x) = \frac{1}{x}. \quad x_0 = -0,5. \quad f(x_0) = -4.$$

$$27.8. S(t) = t^2. \quad S'(t) = 2t. \quad S''(t) = 2.$$

$$\text{a) } t = 1. \quad V = 2 \text{ (м/с)}. \quad a = 2 \text{ (м/с}^2\text{)}.$$

$$\text{б) } t = 2,1. \quad V = 4,2 \text{ (м/с)}. \quad a = 2 \text{ (м/с}^2\text{)}.$$

$$\text{в) } t = 2. \quad V = 4 \text{ (м/с)}. \quad a = 2 \text{ (м/с}^2\text{)}.$$

$$\text{г) } t = 3,5. \quad V = 7 \text{ (м/с)}. \quad a = 2 \text{ (м/с}^2\text{)}.$$

$$27.9. S_1' = 4 \text{ км/ч. } S_2' = 3 \text{ км/ч}$$

$$S_{\max} = 14 \text{ км}$$

$$S_3' = 11 \text{ ч, } t_{\text{отп}} = 3 \text{ ч.}$$

$$27.10. S(t) = 2t^2 + t. \quad t_1 = 0.$$

$$a) t_2 = 0,6. \quad S(t_2) - S(t_1) = 1,32. \quad \frac{\Delta S}{\Delta t} = \frac{1,32}{0,6} = 2,2. \text{ (м/с)}$$

$$б) t_2 = 0,2. \quad S(t_2) - S(t_1) = 0,28. \quad \frac{\Delta S}{\Delta t} \sigma = 1,4. \text{ (м/с)}$$

$$в) t_2 = 0,5. \quad S(t_2) - S(t_1) = 1. \quad \frac{\Delta S}{\Delta t} \sigma \sigma = 2. \text{ (м/с)}$$

$$г) t_2 = 0,1. \quad S(t_2) - S(t_1) = 0,12. \quad \frac{\Delta S}{\Delta t} \sigma = 1,2. \text{ (м/с)}$$

$$27.11. a) S(t) = t^2 + 3. \quad S'(t) = 2t. \quad V_{\text{мгнов}} = 2t. \text{ (м/с)}$$

$$б) S(t) = t^2 - t. \quad S'(t) = 2t - 1. \quad V_{\text{мгнов}} = 2t - 1. \text{ (м/с)}$$

$$в) S(t) = t^2 + 4. \quad S'(t) = 2t. \quad V_{\text{мгнов}} = 2t. \text{ (м/с)}$$

$$г) S(t) = t^2 - 2t. \quad S'(t) = 2t - 2. \quad V_{\text{мгнов}} = 2t - 2. \text{ (м/с)}$$

$$27.12. a) f'(x_1) > 0, f'(x_2) > 0. \quad x_1 = 0 \quad x_2 = 1.$$

$$б) f'(x_1) < 0, f'(x_2) > 0. \quad x_1 = -6; \quad x_2 = 0.$$

$$в) f'(x_1) < 0, f'(x_2) < 0. \quad x_1 = -5; \quad x_2 = -4.$$

$$г) f'(x_1) > 0, f'(x_2) < 0. \quad x_1 = 2; \quad x_2 = 4.$$

$$27.13. a) f'(-7) < f'(-2). \quad б) f'(-4) < f'(2).$$

$$в) f'(-9) < f'(0). \quad г) f'(-1) > f'(5).$$

$$27.14. a) \varphi'(x) > 0; \quad x = -7, -6, -5. \quad б) \varphi'(x) < 0 \text{ и } x > 0; \quad x = 4, 5.$$

$$в) \varphi'(x) < 0; \quad x = -3, -2. \quad г) \varphi'(x) > 0 \text{ и } x < 0; \quad x = -5, -6.$$

§ 28. Вычисление производных

$$28.1. a) y = 7x + 4. \quad y' = 7.$$

$$б) y = x^2. \quad y' = 2x.$$

$$в) y = -6x + 1. \quad y' = -6.$$

$$г) y = \frac{1}{x}. \quad y' = -\frac{1}{x^2}.$$

$$28.2. a) y = \sin x. \quad y' = \cos x.$$

$$б) y = \sqrt{x}. \quad y' = \frac{1}{2\sqrt{x}}.$$

$$в) y = \cos x. \quad y' = -\sin x$$

$$г) y = 10^{10}. \quad y' = 0.$$

$$28.3. a) g(x) = \sqrt{x}. \quad x_0 = 4. \quad g'(x) = \frac{1}{2\sqrt{x}}. \quad g'(x_0) = \frac{1}{4}.$$

$$б) g(x) = x^2. \quad x_0 = -7. \quad g'(x) = 2x. \quad g'(x_0) = -14.$$

$$в) g(x) = -3x - 1. \quad x_0 = -3. \quad g'(x) = -3. \quad g'(x_0) = -3.$$

$$г) g(x) = \frac{1}{x}. \quad x_0 = 0,5. \quad g'(x) = -\frac{1}{x^2}. \quad g'(x_0) = -4.$$

$$28.4. \text{ a) } g(x) = \sin x. x_0 = -\frac{\pi}{2}. g'(x) = \cos x. g'(x_0) = 0.$$

$$\text{б) } g(x) = \cos x. x_0 = \frac{\pi}{6}. g'(x) = -\sin x. g'(x_0) = -\frac{1}{2}.$$

$$\text{в) } g(x) = \cos x. x_0 = -3\pi. g'(x) = -\sin x. g'(x_0) = 0.$$

$$\text{г) } g(x) = \sin x. x_0 = 0. g'(x) = \cos x. g'(x_0) = 1.$$

$$28.5. \text{ a) } h(x) = 7x - 19. x_0 = -2. h'(x_0) = 7.$$

$$\text{б) } h(x) = \sqrt{x}. x_0 = 16. h'(x) = \frac{1}{2\sqrt{x}}. h'(x_0) = \frac{1}{8}.$$

$$\text{в) } h(x) = -6x + 4. x_0 = 0.5. h'(x_0) = -6. \text{ г) } h(x) = \sqrt{x}. x_0 = 9.$$

$$h'(x) = \frac{1}{2\sqrt{x}}. h'(x_0) = \frac{1}{6}.$$

$$28.6. \text{ a) } h(x) = \frac{1}{x}. x_0 = -2. h'(x) = -\frac{1}{x^2}. h'(x_0) = -\frac{1}{4}.$$

$$\text{б) } h(x) = \sin x. x_0 = \frac{\pi}{2}. h'(x) = \cos x. h'(x_0) = 0.$$

$$\text{в) } h(x) = x^2. x_0 = -0.1. h'(x) = 2x. h'(x_0) = -\frac{1}{5}.$$

$$\text{г) } h(x) = \cos x. x_0 = \pi. h'(x) = -\sin x. h'(x_0) = 0.$$

$$28.7. \text{ a) } f(x) = x^2. x_0 = -4. f'(x) = 2x. f'(x_0) = -8.$$

$$\text{б) } f(x) = \frac{1}{x}. x_0 = -\frac{1}{3}. f'(x) = -\frac{1}{x^2}. f'(x_0) = -9.$$

$$\text{в) } f(x) = \frac{1}{x}. x_0 = \frac{1}{2}. f'(x) = -\frac{1}{x^2}. f'(x_0) = -4.$$

$$\text{г) } f(x) = x^2. x_0 = 2. f'(x) = 2x. f'(x_0) = 4.$$

$$28.8. \text{ a) } f(x) = \sin x. x_0 = \frac{\pi}{3}. f'(x) = \cos x. f'(x_0) = \frac{1}{2}.$$

$$\text{б) } f(x) = \cos x. x_0 = -\frac{\pi}{4}. f'(x) = -\sin x. f'(x_0) = \frac{\sqrt{2}}{2}.$$

$$\text{в) } f(x) = \cos x. x_0 = \frac{\pi}{3}. f'(x) = -\sin x. f'(x_0) = -\frac{\sqrt{3}}{2}.$$

$$\text{г) } f(x) = \sin x. x_0 = -\frac{\pi}{6}. f'(x) = \cos x. f'(x_0) = \frac{\sqrt{3}}{2}.$$

$$28.9. \text{ a) } f'(x) = 2x. f(x) = x^2.$$

$$\text{б) } f'(x) = \cos x. f(x) = \sin x.$$

$$\text{в) } f'(x) = 3. f(x) = 3x.$$

$$\text{г) } f'(x) = -\sin x. f(x) = \cos x.$$

28.10.

a) $y = x^2 - 7x$, $y' = 2x - 7$.

б) $y = \sqrt{x} - 9x^2$, $y' = \frac{1}{2\sqrt{x}} - 18x$.

в) $y = 7x^2 + 3x$, $y' = 14x + 3$.

г) $y = \sqrt{x} - 5x^2$, $y' = \frac{1}{2\sqrt{x}} - 10x$.

28.11. а) $y = \frac{1}{x} + 4x$, $y' = \frac{-1}{x^2} + 4$.

б) $y = -2\sqrt{x} - \frac{1}{x}$, $y' = -\frac{1}{\sqrt{x}} + \frac{1}{x^2}$.

в) $y = \frac{1}{x} - 6x$, $y' = -\frac{1}{x^2} - 6$.

г) $\frac{4}{\sqrt{x}} - \frac{1}{x^2}$

28.12. а) $y = \sin x + 3$, $y' = \cos x$.

б) $y = 4\cos x$, $y' = -4\sin x$.

в) $y = \cos x - 6$, $y' = -\sin x$.

г) $y = -2\sin x$, $y' = -2\cos x$.

28.13. а) $y = \cos x + 2x$, $y' = -\sin x + 2$.

б) $y = 3\sin x + \cos x$, $y' = 3\cos x - \sin x$.

в) $y = \sin x - 3x$, $y' = \cos x - 3$.

г) $y = 2\cos x + \sin x$, $y' = -2\sin x + \cos x$.

28.14. а) $y = x^9 \Rightarrow y' = 9x^8$.

б) $y = x^{10}$, $y' = 10x^9$.

в) $y = x^{39} \Rightarrow y' = 39x^{38}$.

г) $y = x^{201}$, $y' = 201x^{200}$.

28.15. а) $y = x^3 + 2x^5$, $y' = 3x^2 + 10x^4$.

б) $y = x^4 - x^9$, $y' = 4x^3 - 9x^8$.

в) $y = x^3 + 4x^{100}$, $y' = 3x^2 + 400x^{99}$.

г) $y = x^4 - 7x^9$, $y' = 4x^3 - 63x^8$.

28.16. а) $y = (x^2 - 1)(x^4 + 2)$.

$y' = (x^4 + 2)2x + (x^2 - 1)(4x^3)$.

б) $y = \sqrt{x}(x^3 + 1)$, $y' = \frac{x^3 + 1}{2\sqrt{x}} + 3x^2\sqrt{x} = \frac{4x^3 + 1}{2\sqrt{x}}$.

в) $y = (x^2 + 3)(x^4 - 1)$, $y' = 2x(x^4 - 1) + (x^2 + 3)4x^3$.

г) $y = \sqrt{x}(x^4 + 2)$, $y' = \frac{x^4 + 2}{2\sqrt{x}} + 4x^3\sqrt{x} = \frac{9x^4 + 2}{2\sqrt{x}}$.

28.17. а) $y = \left(\frac{1}{x} + 1\right)(2x - 3)$, $y' = -\frac{1}{x^2}(2x - 3) + \frac{2}{x} + 2 = 2 + \frac{3}{x^2}$.

б) $y = \sqrt{x} \cos x$, $y' = \frac{\cos x}{2\sqrt{x}} - \sqrt{x} \sin x = \frac{\cos x - 2x \sin x}{2\sqrt{x}}$.

в) $y = \left(\frac{1}{x} + 8\right)(5x - 2)$, $y' = -\frac{1}{x^2}(5x - 2) + \frac{5}{x} + 40 = 40 + \frac{2}{x^2}$.

г) $y = \sqrt{x} \sin x$, $y' = \frac{\sin x}{2\sqrt{x}} + \sqrt{x} \cos x = \frac{\sin x + 2x \cos x}{2\sqrt{x}}$.

$$28.18.) y = \frac{x^3}{2x+4}.$$

$$y' = \frac{3x^2(2x+4) - 2x^3}{4x^2+16x+16} = \frac{4x^3+12x^2}{4x^2+16x+16} = \frac{x^3+3x^2}{x^2+4x+4} = \frac{x^2(x+3)}{(x+2)^2}.$$

$$б) y = \frac{x^2}{x^2-1}. \quad y' = \frac{2x(x^2-1) - 2x^3}{(x^2-1)^2} = \frac{-2x}{(x^2-1)^2}.$$

$$в) y = \frac{x^2}{3-4x}. \quad y' = \frac{2x(3-4x) + 4x^2}{(3-4x)^2} = \frac{6x-4x^2}{(3-4x)^2} = \frac{2x(3-2x)}{(3-4x)^2}.$$

$$г) y = \frac{x}{x^2+1}. \quad y' = \frac{x^2+1-2x^2}{(x^2+1)^2} = \frac{1-x^2}{(x^2+1)^2}.$$

$$28.19. а) y = 3\sin x + \operatorname{ctg} x.$$

$$y' = 3\cos x - \frac{1}{\sin^2 x}.$$

$$б) y = \operatorname{tg} x - \cos x. \quad y' = \frac{1}{\cos^2 x} + \sin x.$$

$$в) y = \cos x + \operatorname{tg} x. \quad y' = -\sin x + \frac{1}{\cos^2 x}.$$

$$г) y = 6\operatorname{tg} x - \sin x. \quad y' = \frac{6}{\cos^2 x} - \cos x.$$

$$28.20. а) y = x\operatorname{tg} x. \quad y' = \operatorname{tg} x + \frac{x}{\cos^2 x}.$$

$$б) y = \sin x \operatorname{tg} x. \quad y' = \sin x + \frac{\sin x}{\cos^2 x}.$$

$$в) y = x\operatorname{ctg} x. \quad y' = \operatorname{ctg} x - \frac{x}{\sin^2 x}.$$

$$г) y = \cos x \operatorname{ctg} x. \quad y' = -\cos x - \frac{\cos x}{\sin^2 x}.$$

28.21.

$$а) y = x^2 + 2x - 1. \quad x_0 = 0. \quad y' = 2x + 2. \quad y'(x_0) = 2.$$

$$б) y = x^3 - 3x + 2. \quad x_0 = -1. \quad y' = 3x^2 - 3. \quad y'(x_0) = 3 - 3 = 0.$$

$$в) y = x^2 + 3x - 4. \quad x_0 = 1. \quad y' = 2x + 3. \quad y'(x_0) = 5.$$

$$г) y = x^3 - 9x^2 + 7. \quad x_0 = 2. \quad y' = 3x^2 - 18x. \quad y'(x_0) = 12 - 36 = -24.$$

$$28.22. а) y = \frac{2}{x} - 1. \quad x_0 = 4. \quad y' = -\frac{2}{x^2}. \quad y'(x_0) = -\frac{1}{8}.$$

$$б) y = \sqrt{x} + 4. \quad x_0 = 9. \quad y' = \frac{1}{2\sqrt{x}}. \quad y'(x_0) = \frac{1}{6}.$$

$$b) y = \frac{8}{x} - 6. x_0 = 1. y' = -\frac{8}{x^2}. y'(x_0) = -8.$$

$$r) y = \sqrt{x} + 5. x_0 = 4. y' = \frac{1}{2\sqrt{x}}. y'(x_0) = \frac{1}{4}.$$

$$28.23. a) g = x^3 + 2x. x_0 = 2.$$

$$g'(x) = 3x^2 + 2. \quad g'(x_0) = 14.$$

$$b) g = (\sqrt{x} + 1)\sqrt{x}. x_0 = 1.$$

$$g'(x) = \frac{\sqrt{x}}{2\sqrt{x}} + \frac{\sqrt{x} + 1}{2\sqrt{x}} = \frac{1}{2} + \frac{1}{2} + \frac{1}{2\sqrt{x}}. \quad g'(x_0) = \frac{3}{2}.$$

$$b) g'(x_0) = 2x_0 + \frac{2}{\sqrt{x_0}} - 4 = 5$$

$$r) g = \frac{1}{x} \left(\frac{4}{x} - 2 \right).$$

$$x_0 = -\frac{1}{2}. g'(x) = -\frac{1}{x^2} \left(\frac{4}{x} - 2 \right) + \frac{1}{x} \left(-\frac{4}{x^2} \right) = -\frac{4}{x^3} + \frac{2}{x^2} - \frac{4}{x^3}.$$

$$g'(x_0) = 4 \cdot 8 + 2 \cdot 4 + 4 \cdot 8 = 72.$$

$$28.24. a) y'(x) = 2 \cos x - 4 \Rightarrow y' \left(\frac{\pi}{3} \right) = -3.$$

$$b) g = \frac{\operatorname{tg} x}{3}. \quad x_0 = -\frac{\pi}{3}. \quad g'(x) = \frac{1}{3 \cos^2 x}. \quad g'(x_0) = \frac{4}{3}.$$

$$b) g = -3 \cos x + x. \quad x_0 = -\frac{\pi}{6}. \quad g'(x) = 3 \sin x + 1. \quad g'(x_0) = -\frac{1}{2}.$$

$$r) g = \frac{\operatorname{ctg} x}{5}. \quad x_0 = \frac{\pi}{3}. \quad g'(x) = -\frac{1}{5 \sin^2 x}. \quad g'(x_0) = -\frac{4}{15}.$$

$$28.25. a) h(x) = x^6 - 4x. \quad x_0 = 1.$$

$$h'(x) = 6x^5 - 4. \quad h'(x_0) = 2. \quad \operatorname{tg} \alpha = 2.$$

$$b) h(x) = \sqrt{x} - 3. \quad x_0 = \frac{1}{4}.$$

$$h'(x) = \frac{1}{2\sqrt{x}}. \quad h'(x_0) = 1. \quad \operatorname{tg} \alpha = 1.$$

$$b) h(x) = -x^5 - 2x^2 + 2. \quad x_0 = -1.$$

$$h'(x) = -5x^4 - 4x. \quad h'(x_0) = -5 + 4 = -1. \quad \operatorname{tg} \alpha = -1.$$

$$r) h(x) = \frac{25}{x} + 2. \quad x_0 = \frac{5}{4}.$$

$$h'(x) = -\frac{25}{x^2}. \quad h'(x_0) = -16. \quad \operatorname{tg} \alpha = -16$$

$$28.26. \text{ a) } f(x) = x^2 \sin x.$$

$$f'(x) = 2x \sin x + x^2 \cos x. \quad f'\left(\frac{\pi}{2}\right) = \pi.$$

$$\text{б) } f(x) = \sqrt{3} \sin x + \frac{x^2}{\pi} + x \sin \frac{\pi}{6}.$$

$$f'(x) = \sqrt{3} \cos x + \frac{2x}{\pi} + \frac{1}{2}. \quad f'\left(\frac{\pi}{6}\right) = \frac{3}{2} + \frac{1}{3} + \frac{1}{2} = 2\frac{1}{3}.$$

$$\text{в) } f(x) = x(1 + \cos x).$$

$$f'(x) = 1 + \cos x + x(-\sin x). \quad f'(\pi) = 1 - 1 + 0 = 0.$$

$$\text{г) } f(x) = \sqrt{3} \cos x - x \cos \frac{\pi}{6} + \frac{x^2}{\pi}. \quad f'(x) = -\sqrt{3} \sin x - \frac{\sqrt{3}}{2} + \frac{2x}{\pi}.$$

$$f'\left(\frac{\pi}{3}\right) = -\frac{3}{2} - \frac{\sqrt{3}}{2} + \frac{2}{3} = \frac{4 - 9 - 3\sqrt{3}}{6} = -\frac{5 + 3\sqrt{3}}{6}.$$

$$28.27. \text{ a) } f(x) = 2\sqrt{x} - 5x + 3. \quad f'(x) = \frac{1}{\sqrt{x}} - 5 = 2. \quad x = \frac{1}{49}.$$

$$\text{б) } f(x) = 3x - \sqrt{x} + 13. \quad f'(x) = 3 - \frac{1}{2\sqrt{x}} = 1. \quad x = \frac{1}{16}.$$

$$28.28. \text{ a) } y = (4x - 9)^7. \quad y' = 7(4x - 9)^6 \cdot 4 = 28(4x - 9)^6.$$

$$\text{б) } y = \left(\frac{x}{3} + 2\right)^{12}. \quad y' = 4\left(\frac{x}{3} + 2\right)^{11}.$$

$$\text{в) } y = (5x + 1)^9. \quad y' = 45(5x + 1)^8.$$

$$\text{г) } y = \left(\frac{x}{4} - 2\right)^{14}. \quad y' = \frac{7}{2}\left(\frac{x}{4} - 2\right)^{13}.$$

$$28.29. \text{ a) } y = \sin(3x - 9). \quad y' = 3\cos(3x - 9).$$

$$\text{б) } y = \cos\left(\frac{\pi}{3} - 4x\right). \quad y' = 4\sin\left(\frac{\pi}{3} - 4x\right).$$

$$\text{в) } y = \cos(9x - 10). \quad y' = -9\sin(9x - 10).$$

$$\text{г) } y = \sin(5 - 3x). \quad y' = -3\cos(5 - 3x).$$

$$28.30. \text{ a) } y = \sqrt{15 - 7x}. \quad y' = \frac{-7}{2\sqrt{15 - 7x}}.$$

$$\text{б) } y = \sqrt{42 + 0,5x}. \quad y' = \frac{1}{4\sqrt{42 + 0,5x}}.$$

$$\text{в) } y = \sqrt{4 + 9x}. \quad y' = \frac{9}{2\sqrt{4 + 9x}}.$$

$$\text{г) } y = \sqrt{50 - 0,2x}. \quad y' = \frac{-1}{10\sqrt{50 - 0,2x}}.$$

28.31.

$$\text{a) } y = (3x - 2)^7. \quad x_0 = 3. \\ y' = 21(3x - 2)^6. \quad y'(x_0) = 3 \cdot 7^7.$$

$$\text{б) } y = \sin\left(\frac{\pi}{6} - 2x\right). \quad x_0 = \frac{\pi}{12}.$$

$$y' = -2 \cos\left(\frac{\pi}{6} - 2x\right). \quad y'(x_0) = -2.$$

$$\text{в) } y = \operatorname{tg}\left(3x - \frac{\pi}{4}\right). \quad x_0 = \frac{\pi}{12}.$$

$$y' = \frac{3}{\cos^2\left(3x - \frac{\pi}{4}\right)}. \quad y'(x_0) = \frac{3}{\cos^2 0^\circ} = 3.$$

$$\text{г) } y = \sqrt{25 - 9x}. \quad x_0 = 1.$$

$$y' = -\frac{9}{2\sqrt{25 - 9x}}. \quad y'(x_0) = -\frac{9}{8} = -1\frac{1}{8}.$$

$$\text{28.32. а) } y = (2x + 1)^5. \quad x_0 = -1. \quad y' = 10(2x + 1)^4. \quad y'(x_0) = 10.$$

$$\text{б) } y = \sqrt{7x - 3}. \quad x_0 = 1. \quad y' = \frac{7}{2\sqrt{7x - 3}}. \quad y'(x_0) = \frac{7}{4} = 1\frac{3}{4}.$$

$$\text{в) } y = \frac{4}{12x - 5}. \quad x_0 = 2. \quad y' = \frac{-12 \cdot 4}{(12x - 5)^2}. \quad y'(x_0) = -\frac{48}{19^2} = -\frac{48}{361}.$$

$$\text{г) } y = \sqrt{11 - 5x}. \quad x_0 = -1. \quad y' = \frac{-5}{2\sqrt{11 - 5x}}. \quad y'(x_0) = -\frac{5}{8}.$$

28.33.

$$\text{а) } y = \sin\left(3x - \frac{\pi}{4}\right). \quad x_0 = \frac{\pi}{4}. \quad y' = 3 \cos\left(3x - \frac{\pi}{4}\right). \quad y'(x_0) = 0.$$

$$\text{б) } y = \operatorname{tg} 6x. \quad x_0 = \frac{\pi}{24}. \quad y' = \frac{6}{\cos^2 6x}. \quad y'(x_0) = \frac{6}{\cos^2 \frac{\pi}{4}} = 12.$$

$$\text{в) } y = \cos\left(\frac{\pi}{3} - 2x\right). \quad x_0 = \frac{\pi}{3}.$$

$$y' = 2 \sin\left(\frac{\pi}{3} - 2x\right). \quad y'(x_0) = 2 \sin\left(-\frac{\pi}{3}\right) = -\sqrt{3}.$$

$$\text{г) } y = \operatorname{ctg} \frac{x}{3}. \quad x_0 = \pi.$$

$$y' = \frac{-1}{3 \sin^2 \frac{x}{3}}. \quad y'(x_0) = -\frac{1}{3 \sin^2 \frac{\pi}{3}} = -\frac{4}{9}.$$

28.34.

$$a) h(x) = (0,5x + 3)^7. \quad x_0 = -4. \quad h'(x) = \frac{7}{2} (0,5x + 3)^6. \quad h'(x_0) = \frac{7}{2} = 3,5.$$

$$b) h(x) = \sqrt{16x + 21}. \quad x_0 = \frac{1}{4}. \quad h'(x) = \frac{8}{\sqrt{16x + 21}}. \quad h'(x_0) = \frac{8}{5} = 1,6.$$

$$в) h(x) = \frac{18}{4x + 1}. \quad x_0 = \frac{1}{2}. \quad h'(x) = \frac{-18 \cdot 4}{(4x + 1)^2}. \quad h'(x_0) = -\frac{72}{9} = -8.$$

$$г) h(x) = \sqrt{6 - 2x}. \quad x_0 = 1. \quad h'(x) = -\frac{1}{\sqrt{6 - 2x}}. \quad h'(x_0) = -\frac{1}{2}.$$

$$28.35. a) f(x) = \sqrt{x} - x. \quad k = 1. \quad f'(x) = \frac{1}{2\sqrt{x}} - 1 = 1.$$

$$1 - 4\sqrt{x} = 0. \quad \sqrt{x} = \frac{1}{4}. \quad x = \frac{1}{16}.$$

$$б) f(x) = \sin x \cos x. \quad k = -\frac{\sqrt{2}}{2}.$$

$$f'(x) = \cos 2x = -\frac{\sqrt{2}}{2}. \quad x = \pm \frac{3\pi}{8} + \pi n.$$

$$в) f(x) = \sqrt{x} + 3x. \quad k = 4. \quad f'(x) = \frac{1}{2\sqrt{x}} + 3 = 4.$$

$$1 - 2\sqrt{x} = 0. \quad x = \frac{1}{4}.$$

$$г) f(x) = \cos^2 x. \quad k = \frac{1}{2}.$$

$$f'(x) = -2\cos x \sin x = -\sin 2x = \frac{1}{2}. \quad x = (-1)^{k+1} \frac{\pi}{12} + \frac{\pi k}{2}.$$

$$28.36. a) f(x) = x^3 - x^4.$$

$$f'(x) = 3x^2 - 4x^3 < 0.$$

$$x^2(3 - 4x) < 0. \quad x > \frac{3}{4}.$$

$$б) f(x) = \frac{1}{5}x^5 - \frac{5}{3}x^3 + 6x.$$

$$f'(x) = x^4 - 5x^2 + 6 < 0.$$

$$(x^2 - 2)(x^2 - 3) < 0 \quad (x - \sqrt{2})(x + \sqrt{2})(x - \sqrt{3})(x + \sqrt{3}) < 0.$$

$$x \in (-\sqrt{3}; -\sqrt{2}) \cup (\sqrt{2}; \sqrt{3}).$$

$$28.37. a) f(x) = \sin 2x.$$

$$f'(x) = 2\cos 2x < 0.$$

$$2x \in \left(\frac{\pi}{2} + 2\pi n; \frac{3\pi}{2} + 2\pi n \right). \quad x \in \left(\frac{\pi}{4} + \pi n; \frac{3\pi}{4} + \pi n \right).$$

$$6) f(x) = -4\cos x + 2x.$$

$$f'(x) = 4\sin x + 2 < 0.$$

$$\sin x < -\frac{1}{2}. \quad x \in \left(-\frac{5\pi}{6} + 2\pi n; -\frac{\pi}{6} + 2\pi n \right).$$

$$28.38. \text{ a) } g(x) = x^3 + x^4.$$

$$g'(x) = 3x^2 + 4x^3 > 0.$$

$$x^2(3 + 4x) > 0 \quad x \in \left(-\frac{3}{4}; 0 \right) \cup (0; +\infty).$$

$$6) g(x) = \frac{4}{2 - 5x}.$$

$$g'(x) = \frac{20}{(2 - 5x)^2} > 0. \quad x \in \mathbb{R}, \text{ но } x \neq \frac{2}{5}.$$

$$28.39. \text{ a) } g(x) = \cos^2 x - \sin^2 x = \cos 2x.$$

$$g'(x) = -2\sin 2x > 0. \quad \sin 2x < 0.$$

$$2x \in (-\pi + 2\pi n; 2\pi n). \quad x \in \left(-\frac{\pi}{2} + \pi n; \pi n \right).$$

$$6) g(x) = \sin^2 x. \quad g'(x) = 2\sin x \cos x = \sin 2x > 0.$$

$$2x \in (2\pi n; \pi + 2\pi n). \quad x \in \left(\pi n; \frac{\pi}{2} + \pi n \right).$$

$$28.40. \text{ a) } h(x) = x^3 - 3x^2 + 1. \quad h'(x) = 3x^2 - 6x > 0.$$

$$x(3x - 6) > 0. \quad x \in (-\infty; 0) \cup (2; +\infty).$$

$$6) h(x) = 4\sqrt{x} - x. \quad h'(x) = \frac{2}{\sqrt{x}} - 1 > 0.$$

$$\frac{2}{\sqrt{x}} > 1. \quad \sqrt{x} < 2. \quad x \in (0; 4).$$

$$6) y = x^3 - x^4 - 19.$$

$$y'(x) = 3x^2 - 4x^3 = x^2(3 - 4x) > 0. \quad x \in (-\infty; 0) \cup (0; \frac{3}{4}).$$

$$7) h(x) = \operatorname{tg} x - 4x.$$

$$h'(x) = \frac{1}{\cos^2 x} - 4 > 0.$$

$$\cos^2 x < \frac{1}{4}, \text{ ОДЗ } x \neq \frac{\pi}{2} + \pi n,$$

$$\cos x \in \left(-\frac{1}{2}, \frac{1}{2} \right) \Rightarrow x \in \left(\frac{\pi}{3} + \pi n, \frac{\pi}{2} + \pi n \right) \cup \left(\frac{\pi}{2} + \pi n, \frac{2\pi}{3} + \pi n \right).$$

$$28.41. \text{ a) } \varphi(x) = \sin x + 3.$$

$$\varphi'(x) = \cos x < 0. \quad x \in \left(\frac{\pi}{2} + 2\pi n; \frac{3\pi}{2} + 2\pi n \right).$$

$$б) \varphi(x) = 0,2x^5 - 3\frac{1}{3}x^3 + 9x.$$

$$\varphi'(x) = x^4 - 10x^2 + 9 < 0.$$

$$(x^2 - 9)(x^2 - 1) < 0. \quad (x - 3)(x + 3)(x - 1)(x + 1) < 0.$$

$$x \in (-3; -1) \cup (1; 3).$$

$$28.42. а) f(x) = \frac{1}{3}x^3 \cdot x^2. \quad g(x) = 7,5x^2 - 16x.$$

$$f'(x) = x^2 \cdot 2x. \quad g'(x) = 15x - 16.$$

$$x^2 - 2x = 15x - 16;$$

$$x^2 - 17x + 16 = 0.$$

$$x = \frac{17 + 15}{2} = 16; \quad x = 1.$$

$$б) f(x) = \sqrt{x}. \quad g(x) = -\frac{1}{x}.$$

$$f'(x) = \frac{1}{2\sqrt{x}}. \quad g'(x) = \frac{1}{x^2}.$$

$$x^2 = 2\sqrt{x}, \quad \frac{1}{2\sqrt{x}} = \frac{1}{x^2}, \quad x \neq 0, \quad x^4 = 4x.$$

$$x(x^3 - 4) = 0. \quad x = 0 \text{ не подходит. } x = \sqrt[3]{4}.$$

$$28.43. а) g(x) = x^3 - 3x^2. \quad h(x) = 1,5x^2 - 9.$$

$$g'(x) = 3x^2 - 6x. \quad h'(x) = 3x.$$

$$3x^2 - 6x > 3x. \quad x^2 - 3x > 0. \quad x \in (-\infty; 0) \cup (3; +\infty).$$

$$б) g(x) = \sin\left(3x - \frac{\pi}{6}\right). \quad h(x) = 6x - 12.$$

$$g'(x) = 3\cos\left(3x - \frac{\pi}{6}\right). \quad h'(x) = 6.$$

$$3\cos\left(3x - \frac{\pi}{6}\right) > 6. \quad \cos\left(3x - \frac{\pi}{6}\right) > 2.$$

Таких значений нет.

$$в) g(x) = \operatorname{tg}x. \quad h(x) = 4x - 81.$$

$$g'(x) = \frac{1}{\cos^2 x}. \quad h'(x) = 4.$$

$$\frac{1}{\cos^2 x} > 4. \quad \cos^2 x < \frac{1}{4}, \quad \cos^2 x \neq 0.$$

$$\cos x \in \left(-\frac{1}{2}; \frac{1}{2}\right), \quad \cos x \neq 0. \quad x \in \left(\frac{\pi}{3} + \pi n; \frac{\pi}{2} + \pi n\right) \cup \left(\frac{\pi}{2} + \pi n; \frac{2\pi}{3} + \pi n\right).$$

$$г) g(x) = \cos\left(\frac{\pi}{4} - 2x\right). \quad h(x) = 3 - \sqrt{2}x.$$

$$g'(x) = 2\sin\left(\frac{\pi}{4} - 2x\right). \quad h'(x) = -\sqrt{2}.$$

$$2 \sin\left(\frac{\pi}{4} - 2x\right) > -\sqrt{2}. \quad \sin\left(-\frac{\pi}{4} + 2x\right) < \frac{\sqrt{2}}{2}.$$

$$2x - \frac{\pi}{4} \in \left(-\frac{5\pi}{4} + 2\pi n; \frac{\pi}{4} + 2\pi n\right). \quad x \in \left(-\frac{\pi}{2} + \pi n; \frac{\pi}{4} + \pi n\right).$$

28.44.

a) $f(x) = \sin(2x - 3)$. $g(x) = \cos(2x - 3)$.

$f'(x) = 2\cos(2x - 3)$. $g'(x) = -2\sin(2x - 3)$.

$\cos(2x - 3) + \sin(2x - 3) = 0$.

$\sin\left(2x - 3 + \frac{\pi}{4}\right) = 0$. $x = \frac{3}{2} - \frac{\pi}{8} + \frac{\pi n}{2}$.

б) $f(x) = \frac{6}{5x - 9}$. $g(x) = \frac{3}{7 - 5x}$.

$g'(x) = \frac{15}{(7 - 5x)^2}$. $f'(x) = -\frac{30}{(5x - 9)^2}$.

$\frac{2}{(5x - 9)^2} = \frac{-1}{(7 - 5x)^2}$. $(5x - 9)^2 + 2(5x - 7)^2 = 0$.

Решений нет.

в) $f(x) = \sqrt{3x - 10}$. $g(x) = \sqrt{6x + 14}$.

$f'(x) = \frac{3}{2\sqrt{3x - 10}}$. $g'(x) = \frac{3}{\sqrt{6x + 14}}$.

$\frac{1}{2\sqrt{3x - 10}} = \frac{1}{\sqrt{6x + 14}}$; $2\sqrt{3x - 10} = \sqrt{6x + 14}$;

$12x - 40 = 6x + 14$; $6x = 54$; $x = 9$.

Проверка: $2\sqrt{17} = \sqrt{68}$.

г) $f(x) = \operatorname{ctg} x$. $g(x) = 2x + 15$.

$f'(x) = -\frac{1}{\sin^2 x}$. $g'(x) = 2$.

$\sin^2 x = -\frac{1}{2}$.

Решений нет.

28.45. а) $h(x) = x^2 - 3x + 19$. $\alpha = 45^\circ$

$h'(x) = 2x - 3 = \operatorname{tg} 45$. $2x - 3 = 1$. $x = 2$.

б) $\frac{4}{x + 2} = h(x)$, $\alpha = 135$.

$h'(x) = \frac{-4}{(x + 2)^2} = \operatorname{tg} 135$. $4 = (x + 2)^2$.

$x = 0$, $x = -4$.

$$в) h(x) = 2\sqrt{2x-4}. \quad \alpha = 60^\circ$$

$$h'(x) = \frac{2}{\sqrt{2x-4}} = \operatorname{tg}60^\circ. \quad 2 = \sqrt{3(2x-4)}.$$

$$4 = 6x - 12. \quad 6x = 16. \quad x = \frac{8}{3} = 2\frac{2}{3}.$$

$$г) h(x) = \sin\left(4x - \frac{\pi}{3}\right). \quad \alpha = 0.$$

$$h'(x) = \cos\left(4x - \frac{\pi}{3}\right) = 0.$$

$$4x - \frac{\pi}{3} = \frac{\pi}{2} + \pi n. \quad x = \frac{5\pi}{24} + \frac{\pi n}{4}.$$

$$28.46. а) y = 4x^2 - |a|x. \quad x(4x - |a|) = 0. \quad x_1 = 0. \quad x_2 = \frac{|a|}{4}.$$

$$y' = 8x - |a|$$

Т.к. оси параболы направлены вверх и т.к. $x_2 \geq x_1$, то

$$1) y'(x_1) = -\operatorname{tg}60^\circ \text{ и } y'(x_2) = \operatorname{tg}60^\circ.$$

$$2) y'(x_1) = -\operatorname{tg}30^\circ \text{ и } y'(x_2) = \operatorname{tg}30^\circ.$$

$$1) y'(0) = -|a| = -\operatorname{tg}60^\circ. \quad a = \pm\sqrt{3}. \quad y'\left(\frac{|a|}{4}\right) = |a| = \operatorname{tg}60^\circ. \quad a = \pm\sqrt{3}.$$

$$2) y'(0) = -|a| = -\operatorname{tg}30^\circ. \quad a = \pm\frac{\sqrt{3}}{3}.$$

$$\text{Ответ: } a = \pm\frac{\sqrt{3}}{3}, \quad a = \pm\sqrt{3}.$$

$$б) y = x^2 + |a|x.$$

$$y' = 2x + |a|. \quad x(x + |a|) = 0. \quad x_1 = 0. \quad x_2 = -|a|.$$

т.к. оси параболы направлены вверх и $x_1 \geq x_2$, то

$$1) y'(x_2) = -\operatorname{tg}\frac{3\pi}{8}.$$

$$2) y'(x_2) = -\operatorname{tg}\frac{\pi}{8}.$$

$$\text{Найдем } \operatorname{tg}\frac{3\pi}{8}:$$

$$\operatorname{tg}\frac{3\pi}{4} = \frac{2\operatorname{tg}\frac{3\pi}{8}}{1 - \operatorname{tg}\frac{3\pi}{8}}. \quad \operatorname{tg}^2\frac{3\pi}{8} - 2\operatorname{tg}\frac{3\pi}{8} - 1 = 0.$$

$$\operatorname{tg}\frac{3\pi}{8} = 1 \pm \sqrt{2}, \text{ но т.к. } 0 < \frac{3\pi}{8} < \frac{\pi}{2}, \text{ то } \operatorname{tg}\frac{3\pi}{8} = 1 + \sqrt{2}.$$

$$\operatorname{tg} \frac{\pi}{4} = \frac{2 \operatorname{tg} \frac{\pi}{8}}{1 - \operatorname{tg}^2 \frac{\pi}{8}}. \quad \operatorname{tg}^2 \frac{\pi}{8} + 2 \operatorname{tg} \frac{\pi}{8} - 1 = 0.$$

$$\operatorname{tg} \frac{\pi}{8} = -1 \pm \sqrt{2}, \text{ но т.к. } 0 < \frac{\pi}{8} < \frac{\pi}{2}, \text{ то } \operatorname{tg} \frac{\pi}{8} = -1 + \sqrt{2}.$$

$$\Rightarrow 1) y'(x_2) = -1 - \sqrt{2}. \quad -|a| = -1 - \sqrt{2}. \quad a = \pm(1 + \sqrt{2}).$$

$$2) y'(x_2) = 1 - \sqrt{2}. \quad a = \pm(\sqrt{2} - 1).$$

$$\text{Ответ: } a = \pm \sqrt{2} \pm 1; \pm \sqrt{2} \mp 1.$$

§ 29. Уравнение касательной к графику функции

29.1. а) $\operatorname{tg} \alpha = 0$. б) $\operatorname{tg} \alpha < 0$. в) $\operatorname{tg} \alpha > 0$.

б) $\operatorname{tg} \alpha < 0$. б) $\operatorname{tg} \alpha < 0$. в) $\operatorname{tg} \alpha > 0$.

29.2. а) $y' = 0$ при $x = 0, x = 3,5$; y' не существует при $x = -1$.

б) $y' = 0$ при $x = -4, x = -1,5$; y' не существует при $x = 4$.

в) $y' = 0$ при $x = -4$; y' не существует при $x = -2$.

г) $y' \neq 0$ при $x \in \mathbb{R}$.

29.3. а) $f(x) = 4 + x^2, a = 2. f'(x) = 2x; f'(a) = 4 \Rightarrow$ острый.

б) $f(x) = 1 - \frac{1}{x}, a = 3. f'(x) = \frac{1}{x^2}; f'(a) = \frac{1}{9} \Rightarrow$ острый.

в) $f(x) = (1-x)^3, a = -3. f'(x) = -3(1-x)^2; f'(a) = -48 \Rightarrow$ тупой.

г) $f(x) = 2x - x^3, a = 1. f'(x) = 2 - 3x^2; f'(a) = -1 \Rightarrow$ тупой.

29.4. $y = 1 - x^2; y'(x) = -2x$.

а) $A(0; 1); y'(0) = 0 \Rightarrow \operatorname{tg} \alpha = 0$.

б) $B(2; -3); y'(2) = -4 \Rightarrow \operatorname{tg} \alpha = -4$.

в) $C\left(\frac{1}{2}; \frac{3}{4}\right); y'\left(\frac{1}{2}\right) = -1 \Rightarrow \operatorname{tg} \alpha = -1$.

г) $D(-1; 0); y'(-1) = 2 \Rightarrow \operatorname{tg} \alpha = 2$.

28.5. а) $f(x) = x^3 - 2x^2 + 3, a = -1. f'(x) = 3x^2 - 4x; f'(a) = 7, \operatorname{tg} \alpha = 7$.

б) $f(x) = \sqrt{4-5x}, a = 0. f'(x) = -\frac{5}{2\sqrt{4-5x}}; f'(a) = -\frac{5}{4}; \operatorname{tg} \alpha = -\frac{5}{4}$.

в) $f(x) = x^4 - 7x^3 + 12x - 45, a = 0. f'(x) = 4x^3 - 21x^2 + 12; f'(a) = 12, \operatorname{tg} \alpha = 12$.

г) $f(x) = \sqrt{10+x}, a = -5. f'(x) = \frac{1}{2\sqrt{x+10}}; f'(a) = \frac{1}{2\sqrt{5}}; \operatorname{tg} \alpha = \frac{\sqrt{5}}{10}$.

29.6. а) $f(x) = \sin x, a = 0. f'(x) = \cos x; f'(a) = 1; \operatorname{tg} \alpha = 1$.

б) $f(x) = \operatorname{tg} 2x, a = \frac{\pi}{8}. f'(x) = \frac{2}{\cos^2 2x}; f'(a) = 4; \operatorname{tg} \alpha = 4$.

$$\text{в) } f(x) = \cos 3x, a = \frac{\pi}{2}. f'(x) = -3\sin 3x; f'(a) = 3; \operatorname{tg} \alpha = 3.$$

$$\text{г) } f(x) = \sin x \quad f'(x) = \cos x, f'(a) = \frac{1}{2}, \operatorname{tg} \alpha = \frac{1}{2}.$$

$$29.7. \text{ а) } f(x) = x^2, a = 0,5. f'(x) = 2x; f'(a) = 1; \alpha = \frac{\pi}{4}.$$

$$\text{б) } f(x) = -3x^3, a = \frac{1}{3}. f'(x) = -9x^2; f'(a) = -1; \alpha = \frac{3\pi}{4}.$$

$$\text{в) } f(x) = 0,2x^5, a = -1. f'(x) = x^4; f'(a) = 1; \alpha = \frac{\pi}{4}.$$

$$\text{г) } f(x) = -0,25x^4, a = 0. f'(x) = -x^3; f'(a) = 0; \alpha = 0.$$

$$29.8. \text{ а) } f(x) = x^3 - 3x^2 + 2x - 7, \quad a = 1.$$

$$f'(x) = 3x^2 - 6x + 2, f'(a) = -1, \quad \alpha = \frac{3\pi}{4}.$$

$$\text{б) } f(x) = -7x^3 + 10x^2 + x - 12, \quad a = 0.$$

$$f'(x) = -21x^2 + 20x + 1 \quad f'(a) = 1 \quad \alpha = \frac{\pi}{4}.$$

$$29.9. \text{ а) } f(x) = \frac{2x-1}{3-2x}, a = \frac{1}{2}. f'(x) = \frac{6-4x+4x-2}{(3-2x)^2} = \frac{4}{(3-2x)^2}$$

$$f'(a) = 1 \quad \alpha = \frac{\pi}{4}.$$

$$\text{б) } f(x) = \frac{x-1}{x-2}, a = 1. f'(x) = \frac{x-2-x+1}{(x-2)^2} = -\frac{1}{(x-2)^2}$$

$$f'(a) = -1 \quad \alpha = \frac{3\pi}{4}.$$

$$29.10. \text{ а) } f(x) = \sqrt{6x+7}, \quad a = 3\frac{1}{3}. f'(x) = \frac{3}{\sqrt{6x+7}}$$

$$f'(a) = \frac{1}{\sqrt{3}} \quad \alpha = \frac{\pi}{6}.$$

$$\text{б) } f(x) = \sqrt{5-2x}, \quad a = 2. f'(x) = -\frac{1}{\sqrt{5-2x}}$$

$$f'(a) = -1 \quad \alpha = \frac{3\pi}{4}.$$

$$29.11. \text{ а) } f(x) = \sqrt{3} \cos \frac{x}{3}, \quad a = \frac{3\pi}{2}. f'(x) = -\frac{\sqrt{3}}{3} \sin \frac{x}{3}$$

$$f'(a) = -\frac{\sqrt{3}}{3} \quad \alpha = \frac{5\pi}{6}.$$

$$6) f(x) = \frac{1}{2} \sin 2x, \quad a = \frac{\pi}{2}, \quad f(x) = \cos 2x$$

$$f'(a) = -1 \quad \alpha = \frac{3\pi}{4}$$

$$29.12. \text{ a) } f(x) = x^2, \quad a = 3, \quad f(x) = 2x$$

$$f'(a) = 6, \quad f(a) = 9, \quad y = 9 + 6(x-3) = 6x - 9.$$

$$6) f(x) = 2 - x - x^3, \quad a = 0, \quad f(x) = -1 - 3x^2$$

$$f'(a) = -1, \quad f(a) = 2, \quad y = 2 - x.$$

$$\text{в) } f(x) = x^3, \quad a = 1, \quad f(x) = 3x^2$$

$$f'(a) = 3, \quad f(a) = 1, \quad y = 1 + 3(x-1) = 3x - 2.$$

$$\text{г) } f(x) = x^2 - 3x + 5, \quad a = -1, \quad f(a) = 1 + 3 + 5 = 9.$$

$$f'(x) = 2x - 3, \quad f'(a) = -5, \quad y = 9 - 5(x+1) = -5x + 4.$$

$$29.13. \text{ a) } f(x) = \frac{3x-2}{3-x}, \quad a = 2, \quad f(a) = 4.$$

$$f'(x) = \frac{9-3x+3x-2}{(3-x)^2} = \frac{7}{(x-3)^2} \quad f'(a) = 7.$$

$$y = 4 + 7(x-2) = 7x - 10.$$

$$6) f(x) = \frac{2x-5}{5-x}, \quad a = 4, \quad f(a) = 3.$$

$$f'(x) = \frac{10-2x+2x-5}{(5-x)^2} = \frac{5}{(5-x)^2} \quad f'(a) = 5.$$

$$y = 3 + 5(x-4) = 5x - 17.$$

29.14.

$$\text{a) } f(x) = 2\sqrt{3x-5}, \quad a = 2, \quad f(a) = 2;$$

$$f'(x) = \frac{3}{\sqrt{3x-5}}, \quad f'(a) = 3, \quad y = 2 + 3(x-2) = 3x - 4.$$

$$6) f(x) = \sqrt{7-2x}, \quad a = 3, \quad f(a) = 1;$$

$$f'(x) = -\frac{1}{\sqrt{7-2x}}, \quad f'(a) = -1, \quad y = 1 - x + 3 = -x + 4.$$

$$29.15. \text{ a) } f(x) = \cos \frac{x}{3}, \quad a = 0, \quad f(a) = 1;$$

$$f'(x) = -\frac{1}{3} \sin \frac{x}{3}, \quad f'(a) = 0, \quad y = 1.$$

$$\text{в) } f(x) = \sin 2x, \quad a = \frac{\pi}{4}, \quad f(a) = 1;$$

$$f'(x) = 2\cos 2x \quad f'(a) = 0; \quad y = 1.$$

$$29.16. \text{ a) } f(x) = \operatorname{ctg} 2x, a = \frac{\pi}{4}, f(a) = 0;$$

$$f'(x) = -\frac{2}{\sin^2 2x}, \quad f'(a) = -2, \quad y = -2\left(x - \frac{\pi}{4}\right) = \frac{\pi}{2} - 2x.$$

$$\text{б) } f(x) = 2 \operatorname{tg} \frac{x}{3}, \quad a = 0, \quad f(a) = 0;$$

$$f'(x) = \frac{2}{3 \cos^2 \frac{x}{3}}, \quad f'(a) = \frac{2}{3}; \quad y = \frac{2}{3}x.$$

$$29.17. y = 9 - x^2; \quad 9 - x^2 = 0, \quad x = \pm 3, \quad y' = -2x.$$

$$y'(3) = -6, \quad y'(-3) = 6, \quad y = 6(x + 3) = 6x + 18.$$

$$y = -6(x - 3) = 18 - 6x.$$

$$29.18. y = x^2 - 3x; \quad x^2 - 3x - 4 = 0, \quad x = 4, \quad x = -1.$$

$$y' = 2x - 3, \quad y'(4) = 8 - 3 = 5, \quad y'(-1) = -5;$$

$$y = 4 + 5(x - 4) = 5x - 16;$$

$$y = 4 - 5(x + 1) = -5x - 1.$$

$$29.19. y = x^3 - 3x^2 + 4x + 1$$

$$y' = 3x^2 - 6x + 4, \quad \angle d = 45^\circ \Rightarrow y' = \pm 1$$

$$\begin{cases} 3x^2 - 6x + 4 = 1 \\ 3x^2 - 6x + 4 = -1 \end{cases} \begin{cases} (x-1)^2 = 0 \\ 3x^2 - 6x + 5 = 0 \end{cases}$$

$$x = 1, \quad y(1) = 1 - 3 + 4 + 1 = 3$$

$$\text{Касательная } y = 2 + x$$

$$\text{Ответ: } (1, 3), y = x + 2$$

(В ответах задачника опечатка).

$$29.20. y = x^2, \quad y' = 2x.$$

$$y = x_0^2 + 2x_0(x - x_0) = 2x_0x - x_0^2.$$

$$\text{а) } y = 2x + 1, \quad x_0 = 1, \quad y_0 = 1;$$

$$\text{б) } y = -\frac{1}{2}x + 5, \quad x_0 = -\frac{1}{4}, \quad y_0 = \frac{1}{16};$$

$$\text{в) } \frac{3}{4}x - 2 = y, \quad x_0 = \frac{3}{8}, \quad y_0 = \frac{9}{64}$$

$$\text{г) } y = -x + 5, \quad x_0 = -\frac{1}{2}, \quad y_0 = \frac{1}{4}.$$

$$29.21. \text{ а) } f(x) = \frac{x^3}{3} - 3x^2 + 10x - 4, \quad y = x + 3.$$

$$f'(x) = x^2 - 6x + 10.$$

$$y = \frac{x_0^3}{3} - 3x_0^2 + 10x_0 - 4 + (x_0^2 - 6x_0 + 10)(x - x_0) \text{ — касательная.}$$

$$x_0^2 - 6x_0 + 10 = 1, \quad x_0^2 - 6x_0 + 9 = 0, \quad x_0 = 3.$$

$$\text{б) } f(x) = \frac{x^4}{4} - x^2 + 8, \quad y = 0.$$

$$f'(x) = x^3 - 2x,$$

$$y = \frac{x_0^4}{4} - x_0^2 + 8 + (x_0^3 - 2x_0)(x - x_0):$$

$$x_0^3 - 2x_0 = 0, \quad x_0 = 0, \quad x_0^2 = 2, \quad x_0 = \pm\sqrt{2};$$

$$\text{в) } f(x) = \frac{x^3}{3} - x^2 + 2x - 7, \quad y = x - 3,$$

$$f'(x) = x^2 - 2x + 2,$$

$$y = \frac{x_0^3}{3} - x_0^2 + 2x_0 - 7 + (x_0^2 - 2x_0 + 2)(x - x_0),$$

$$x_0^2 - 2x_0 + 2 = 1, \quad x_0 = 1;$$

$$\text{г) } f(x) = \frac{5x^4}{4} - x^3 + 6, \quad y = 2,$$

$$f'(x) = 5x^3 - 3x^2,$$

$$x_0 = 0, \quad 5x_0 - 3 = 0, \quad x_0 = \frac{3}{5}.$$

29.22.

$$\text{а) } f(x) = \sin x, \quad y = -x, \quad f'(x) = \cos x,$$

$$\cos x_0 = -1, \quad x_0 = \pi + 2\pi n;$$

$$\text{б) } f(x) = \cos 3x, \quad y = 0, \quad f'(x) = -3\sin 3x.$$

$$\sin 3x_0 = 0, \quad x_0 = \frac{\pi n}{3};$$

$$\text{в) } f(x) = \operatorname{tg} x, \quad y = x - 3, \quad f'(x) = \frac{1}{\cos^2 x},$$

$$\frac{1}{\cos^2 x} = 1, \quad \cos x = \pm 1, \quad x = \pi n;$$

$$\text{г) } f(x) = \sin \frac{x}{2}, \quad y = -1, \quad f'(x) = \frac{1}{2} \cos \frac{x}{2},$$

$$\cos \frac{x}{2} = 0, \quad x_0 = \pi + 2\pi n.$$

29.23. $y = \frac{x^3}{3} - 2.$

$$y' = x^2, \quad y = \frac{x_0^3}{3} - 2 + x_0^2(x - x_0) = x_0^2 x - \frac{2}{3}x_0^3 - 2.$$

$$a) y = x - 3, \quad x_0^2 = 1, \quad x_0 = \pm 1;$$

$$y = x - \frac{2}{3} - 2 = x - \frac{8}{3}, \quad y = x + \frac{2}{3} - 2 = x - 1\frac{1}{3}.$$

$$б) y = 9x - 5.$$

$$x_0^2 = \pm 3, \quad y = 9x - 18 - 2 = 9x - 20.$$

$$y = 9x + 18 - 2 = 9x + 16.$$

$$29.24. a) 0,998^5.$$

$$y = x^5 = f(x), \quad x = 0,998; \quad a = 1. \quad f(a) = 1.$$

$$f'(x) = 5x^4, \quad f'(a) = f'(1) = 5.$$

$$0,998^5 \approx 1 - 5 \cdot 0,002 = 0,99.$$

$$б) \sqrt{1,05} \approx 1 + \frac{1}{2} \cdot 0,05 = 1,025$$

$$в) 1,03^7 \approx 1 + 7 \cdot 0,03 = 1,21.$$

$$г) \sqrt{3,99} \approx 2 - \frac{1}{2\sqrt{4}} \cdot 0,01 = 1,9975.$$

$$29.25. a) f(x) = \sqrt{3-x}, \quad B(-2; 3),$$

$$f'(x) = -\frac{1}{2\sqrt{3-x}}.$$

$$3 = \sqrt{3-x_0} - \frac{1}{2\sqrt{3-x_0}}(-2-x_0); \quad 3 = \frac{6-2x_0+2+x_0}{2\sqrt{3-x_0}};$$

$$6\sqrt{3-x_0} = 8-x_0. \quad 108-36x_0 = 64-16x_0+x_0^2.$$

$$x_0^2 + 20x_0 - 44 = 0. \quad x_0 = -22. \quad x_0 = 2. \quad f(-22) = 5. \quad f(2) = 1.$$

$$y = 5 - \frac{1}{10}(x+22) = -\frac{x}{10} - \frac{11}{5} + 5 = -\frac{x}{10} + \frac{14}{5}.$$

$$y = 1 - \frac{1}{2}(x-2) = -\frac{1}{2}x + 2.$$

$$б) f(x) = \sqrt{3-x}, \quad B(4; 0).$$

$$0 = \sqrt{3-x_0} - \frac{1}{2\sqrt{3-x_0}}(4-x_0); \quad 6-2x_0-4+x_0=0;$$

$$x_0 = 2; \quad f(2) = 1;$$

$$y = 1 - \frac{1}{2}(x-2) = -\frac{1}{2}x + 2.$$

$$29.26. y = \frac{1}{x^2}, \quad x < 0, \quad -\frac{1}{2}xy = \frac{9}{8}; \quad y = \frac{3}{x_0^2} - \frac{2x}{x_0^3}.$$

$$\text{При } x = 0 \quad y = \frac{3}{x_0^2}. \quad \text{При } y = 0 \quad x = \frac{3x_0}{2}.$$

$$\frac{3 \cdot 3}{2} \cdot \frac{1}{x_0} = -\frac{9}{4}; \quad \frac{1}{x_0} = -\frac{1}{2}; \quad x_0 = -2.$$

$$y = \frac{3}{4} + \frac{2x}{8} = \frac{3+x}{4}.$$

$$29.27. y = \frac{\sqrt{3}}{6}(1-x^2), \quad \alpha = 120^\circ; \quad y' = -\frac{\sqrt{3}}{3}x.$$

$$y = -\frac{\sqrt{3}}{3}x_0x + \frac{\sqrt{3}}{3}x_0^2 - \frac{\sqrt{3}x_0^2}{6} + \frac{\sqrt{3}}{6} = -\frac{\sqrt{3}}{3}x_0x + \frac{\sqrt{3}}{6}x_0^2 + \frac{\sqrt{3}}{6}.$$

$$1. y' = -\frac{\sqrt{3}}{3}x_0 = \pm \operatorname{tg}60^\circ. \quad \frac{\sqrt{3}}{3}x_0 = \pm\sqrt{3}. \quad x_0 = \pm 3.$$

$$y = -\sqrt{3}x + \frac{3\sqrt{3}}{2} + \frac{\sqrt{3}}{6} = -\sqrt{3}x + \frac{5\sqrt{3}}{3}. \quad y = \sqrt{3}x + \frac{5\sqrt{3}}{3}.$$

$$2. y' = -\frac{\sqrt{3}}{3}x_0 = \pm \operatorname{tg}30^\circ. \quad x_0 = \pm 1. \quad y = \frac{\sqrt{3}}{3}x + \frac{\sqrt{3}}{3}. \quad y = -\frac{\sqrt{3}}{3}x + \frac{\sqrt{3}}{3}.$$

$$\text{Ответ: } y = \pm \frac{\sqrt{3}}{3}(x \pm 1). \quad y = \pm \sqrt{3}\left(x \pm \frac{5}{3}\right).$$

§ 30. Применение производной исследования функций на монотонность и экстремумы

$$30.1. \text{ а) } f'(a) > 0. f'(b) > 0. f'(c) < 0. f'(d) > 0.$$

$$\text{ б) } f'(a) > 0. f'(b) = 0. f'(c) = 0. f'(d) > 0.$$

$$30.2. \text{ а) } \text{Ф-ция возрастает: } \left(-\infty; \frac{c+b}{2}\right) \cup \left[d - \frac{c-b}{2}; +\infty\right).$$

$$\text{убывает: } \left[\frac{c+b}{2}; d - \frac{c-b}{2}\right]$$

$$\text{ б) возрастает: } (-\infty; b] \cup [c; +\infty); \quad \text{убывает: } [b; c]$$

$$30.3. \text{ а) убывает: } [-2; 2]; \quad \text{возрастает: } (+\infty; -2] \cup [2; +\infty)$$

$$\text{ б) убывает: } [-4; 0] \cup [3; +\infty); \quad \text{возрастает: } (-\infty; -4] \cup [0; 3]$$

$$\text{ в) убывает: } [-4,5; +\infty); \quad \text{возрастает: } (-\infty; -4,5]$$

$$\text{ г) убывает: } (-\infty; -2,5] \cup [2,5; +\infty); \quad \text{возрастает: } [-2,5; 2,5]$$

$$30.4. \text{ в)}$$

$$30.5. \text{ для Ф-ции } g(x).$$

$$30.6. \text{ а) } f(x); \quad \text{ б) } h(x)$$

30.7.

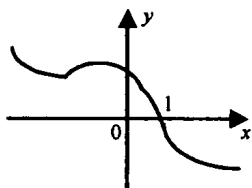

30.8.

а)

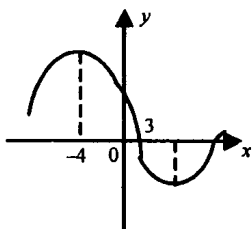

б)

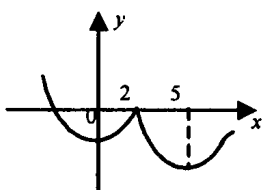

в)

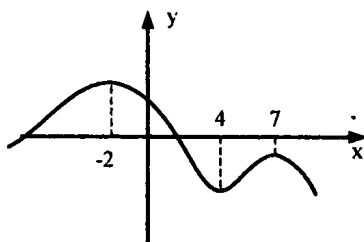

г)

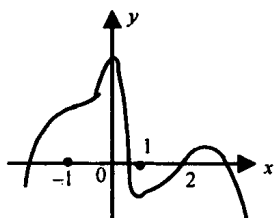

30.9. а) $y = \cos x + 2x$.

$$y' = -\sin x + 2 \quad y' > 0 \text{ при любых } x.$$

б) $y = x^5 + 3x^3 + 7x + 4$.

$$y' = 5x^4 + 9x^2 + 7. \quad y' > 0 \text{ при любых } x.$$

в) $y = \sin x + x^3 + x$.

$$y' = \cos x + 3x^2 + 1. \quad y' > 0 \text{ при любых } x.$$

г) $y = x^5 + 4x^3 + 8x - 8$.

$$y' = 5x^4 + 12x^2 + 8. \quad y' > 0 \text{ при любых } x.$$

30.10. а) $y = \sin 2x - 3x$.

$$y' = 2\cos 2x - 3. \quad y' < 0 \text{ при любых } x.$$

б) $y = \cos 3x - 4x$. $y' = -3\sin 3x - 4$.

$$y' < 0 \text{ при любых } x.$$

30.11. а) $y = x^5 + 6x^3 - 7$.

$$y' = 5x^4 + 18x^2 \geq 0, \text{ функция возрастает.}$$

б) $y = \sin x - 2x - 15$. $y' = \cos x - 2 < 0$, убывает.

в) $y = x - \cos x + 8$. $y' = 1 + \sin x \geq 0$, функция возрастает.

г) $y = 11 - 5x - x^3$. $y' = -5 - 3x^2 < 0$, функция убывает.

30.12. а) $y = x^2 - 5x + 4$. $y' = 2x - 5$.

При $x \geq \frac{5}{2}$ ф-ция возрастает.

При $x \leq \frac{5}{2}$ ф-ция убывает.

б) $y = 5x^2 + 15x - 1$. $y' = 10x + 15$.

При $x \geq -\frac{3}{2}$ ф-ция возрастает.

При $x \leq -\frac{3}{2}$ ф-ция убывает.

в) $y = -x^2 + 8x - 7$. $y' = -2x + 8$.

При $x \geq 4$ ф-ция убывает.

При $x \leq 4$ ф-ция возрастает.

г) $y = x^2 - x$. $y' = 2x - 1$.

При $x \geq \frac{1}{2}$ ф-ция возрастает.

При $x \leq \frac{1}{2}$ ф-ция убывает.

30.13. а) $y = x^3 + 2x$. $y' = 3x^2 + 2$.

Возрастает при любых x .

б) $y = 60 + 45x - 3x^2 - x^3$.

$y' = 45 - 6x - 3x^2 = -3(x^2 + 2x - 15)$.

$x \in [-5; 3]$ возрастает. $x \in (-\infty; -5] \cup [3; +\infty)$ убывает.

в) $y = 2x^3 - 3x^2 - 36x + 40$. $y' = 6x^2 - 6x - 36 = 6(x^2 - x - 6)$.

$x \in [-2; 3]$ убывает. $x \in (-\infty; -2] \cup [3; +\infty)$ возрастает.

г) $y = -x^5 + 5x$. $y' = -5x^4 + 5 = -5(x^4 - 1)$.

$x \in [-1; 1]$ возрастает. $x \in (-\infty; -1] \cup [1; +\infty)$ убывает.

30.14. а) $y = x^4 - 2x^2 - 3$. $y' = 4x^3 - 4x = 4x(x^2 - 1) = 4x(x - 1)(x + 1)$.

$x \in (-\infty; -1] \cup [0; 1]$ убывает. $x \in [-1; 0] \cup [1; +\infty)$ возрастает.

б) $y = -x^5 - x$. $y' = -5x^4 - 1 = -(5x^4 + 1) < 0$. убывает при всех x .

в) $y = -3x^4 + 4x^3 - 15$. $y' = -12x^3 + 12x^2 = -12x^2(x - 1)$.

$x \in (-\infty; 1]$ возрастает. $x \geq 1$ убывает.

г) $y = 5x^5 - 1$. $y' = 25x^4$. возрастает при всех x .

30.15. а) $y = \frac{1}{x+3}$;

$y' = -\frac{1}{(x+3)^2}$. Убывает на всей ОДЗ ($x \neq -3$).

$$б) y = \frac{3x-1}{3x+1}$$

$$y' = \frac{9x+3-9x+3}{(3x+1)^2} = \frac{2}{(3x+1)^2}, \text{ возрастает на всей ОДЗ } (x \neq -\frac{1}{3}).$$

$$в) y = \frac{2}{x} + 1,$$

$$y' = -\frac{2}{x^2}, \text{ убывает на всей ОДЗ } (x \neq 0).$$

$$г) y = \frac{1-2x}{3+2x},$$

$$y' = \frac{-6-4x-2+4x}{(3+2x)^2} = -\frac{8}{(3+2x)^2}, \text{ убывает на всей ОДЗ } (x \neq -\frac{3}{2}).$$

$$30.16. а) y = \sqrt{3x-1},$$

$$y' = \frac{3}{2\sqrt{3x-1}}, \text{ возрастает на всей ОДЗ } (x \geq \frac{1}{3}).$$

$$б) y = \sqrt{1-x} + 2x,$$

$$y' = -\frac{1}{2\sqrt{1-x}} + 2 = 0, \quad \frac{4\sqrt{1-x}-1}{2\sqrt{1-x}} = 0, \quad x = \frac{15}{16}.$$

$$x \in \left(-\infty; \frac{15}{16}\right], \text{ возрастает. } x \in \left[\frac{15}{16}; 1\right] \text{ убывает.}$$

$$в) y = \sqrt{1-2x},$$

$$y' = -\frac{1}{\sqrt{1-2x}}, \quad x \in \left(-\infty; \frac{1}{2}\right] \text{ убывает.}$$

$$г) y = \sqrt{2x-1} - x,$$

$$y' = \frac{1}{\sqrt{2x-1}} - 1 = 0, \quad \frac{1-\sqrt{2x-1}}{\sqrt{2x-1}} = 0;$$

$$x \in \left[\frac{1}{2}; 1\right] \text{ возрастает. } x \in [1; +\infty) \text{ убывает.}$$

$$30.17. а) f'(b) = f'(d) = 0.$$

$$б) f'(c) = 0.$$

$$в) f'(a) = f'(0) = 0.$$

г) нет точек, в которых производная равна нулю.

$$30.18. а) е$$

$$б) a, b$$

$$в) b, c$$

$$г) a, b, c, d, e$$

$$30.19. а) 1$$

$$б) 2$$

$$в) 2$$

$$г) 2$$

$$30.20. а) 2$$

$$б) 1$$

$$в) 2$$

$$г) 2$$

$$30.21. а) (-\infty; -5] \cup [-2; +\infty)$$

$$б) [-5; -2]$$

$$в) -5.$$

$$г) -2.$$

30.22. а)

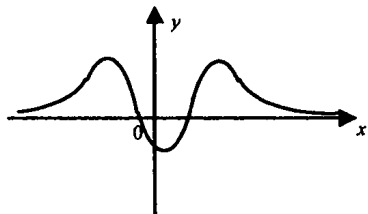

б)

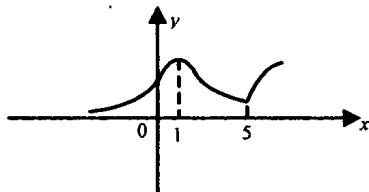

в)

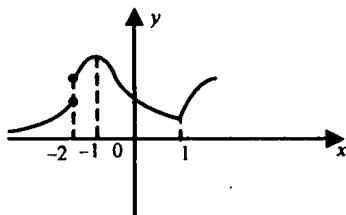

г)

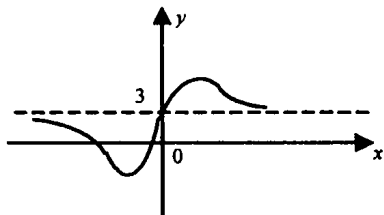

30.23. а) да; б) нет; в) нет; г) нет.

30.24. а) $y = x^3 - 3ax^2 + 27x - 5$;

$$y' = 3x^2 - 6ax + 27$$
;

$$x^2 - 2ax + 9 = 0; \quad \frac{D}{4} = a^2 - 9 = 0; \quad a = \pm 3.$$

б) $y = x^3 - 3ax^2 + 75x - 10$;

$$y' = 3x^2 - 6ax + 75$$
;

$$x^2 - 2ax + 25 = 0; \quad \frac{D}{4} = a^2 - 25 = 0; \quad a = \pm 5.$$

30.25. а) Да.

б) Да.

в) Да.

г) Да.

30.26. а) $y = 7 + 12x - x^3$;

$$y' = 12 - 3x^2; \quad 3x^2 = 12; \quad x = \pm 2.$$

б) $y = 8 + 2x^2 - x^4$; $y' = 4x - 4x^3$;

$$4x(1 - x^2) = 0; \quad x = 0, x = \pm 1.$$

в) $y = 3x^3 + 2x^2 - 7$; $y' = 9x^2 + 4x$;

$$x(9x + 4) = 0; \quad x = 0, \quad x = -\frac{4}{9}.$$

г) $y = x^4 - 8x^2$; $y' = 4x^3 - 16x$;

$$4x(x^2 - 4) = 0; \quad x = 0, x = \pm 2.$$

30.27.

$$a) y = 2x + \frac{8}{x}; \quad y' = 2 - \frac{8}{x^2} = 0; \quad x = \pm 2$$

$$б) \sqrt{2x-1} = y;$$

$$y' = \frac{1}{\sqrt{2x-1}} \quad x = \frac{1}{2} \text{ -- критическая}$$

$$в) y = \frac{x}{5} + \frac{5}{x}; \quad y' = \frac{1}{5} - \frac{5}{x^2} = 0; \quad x^2 - 25 = 0; \quad x = \pm 5.$$

$$г) y = (x-3)^4; \quad y' = 4(x-3)^3 = 0 \quad x = 3.$$

$$30.28. a) y = \frac{x^3}{3} - \frac{5}{2}x^2 + 6x - 1;$$

$$y' = x^2 - 5x + 6 = 0; \quad x = 2, \quad x = 3. \quad x = 2 - \max, \quad x = 3 - \min.$$

$$б) y = x^3 - 27x + 26;$$

$$y' = 3x^2 - 27 = 0; \quad x = \pm 3; \quad x = -3 - \max, \quad x = 3 - \min.$$

$$в) y = x^3 - 7x^2 - 5x + 11;$$

$$y' = 3x^2 - 14x - 5 = 0; \quad x = \frac{7+8}{3} = 5; \quad x = -\frac{1}{3}; \quad x = 5 - \min,$$

$$x = -\frac{1}{3} - \max.$$

$$г) y = -2x^3 + 21x^2 + 19;$$

$$y' = -6x^2 + 42x = 0; \quad x^2 - 7x = 0; \quad x(x-7) = 0;$$

$$x = 0, \quad x = 7;$$

$$x = 7 - \max, \quad x = 0 - \min.$$

$$30.29. a) y = -5x^5 + 3x^3;$$

$$y' = -25x^4 + 9x^2; \quad x^2(9 - 25x^2) = 0$$

$$x = 0, \quad x^2 = \frac{9}{25}, \quad x = \pm \frac{3}{5}; \quad x = \frac{3}{5} - \max, \quad x = -\frac{3}{5} - \min.$$

$$б) y = x^4 - 4x^3 - 8x^2 + 13;$$

$$y' = 4x^3 - 12x^2 - 16x; \quad 4x(x^2 - 3x - 4) = 0;$$

$$x = 0, \quad x = 4, \quad x = -1; \quad x = 4, \quad x = -1 - \min, \quad x = 0 - \max.$$

$$в) y = x^4 - 50x^2;$$

$$y' = 4x^3 - 100x \quad 4x(x^2 - 25) = 0 \quad x = 0 \quad x = \pm 5$$

$$x = -5, x = 5 - \min, \quad x = 0 - \max.$$

$$r) y = 2x^5 + 5x^4 - 10x^3 + 3;$$

$$y' = 10x^4 + 20x^3 - 30x^2; 10x^2(x^2 + 2x - 3) = 0;$$

$$x = 0, \quad x = -3; \quad x = 1,$$

$$x = -3 - \max, \quad x = 1 - \min.$$

$$30.30. a) y = x + \frac{4}{x};$$

$$y' = 1 - \frac{4}{x^2} = 0; \quad x = \pm 2, x = 2 - \min, x = -2 - \max.$$

$$b) y = \frac{x^2 + 9}{x} = x + \frac{9}{x};$$

$$y' = 1 - \frac{9}{x^2} = 0; \quad x = \pm 3, x = 3 - \min, x = -3 - \max.$$

$$30.31. a) y = x - 2\sqrt{x-2};$$

$$y' = 1 - \frac{1}{\sqrt{x-2}} = 0; \quad \sqrt{x-2} = 1; \quad x = 3, \quad x = 3 - \min.$$

$$b) y = 4\sqrt{2x-1} - x;$$

$$y' = \frac{4}{\sqrt{2x-1}} - 1 = 0; \quad \sqrt{2x-1} = 4; \quad x = 8,5 - \max.$$

$$30.32. a) y = x - 2\cos x, \quad x \in [-\pi; \pi];$$

$$y' = 1 + 2\sin x; \quad \sin x = -\frac{1}{2}; \quad x = (-1)^{k+1} \frac{\pi}{6} + \pi k;$$

$$x = -\frac{5\pi}{6} - \max; \quad x = -\frac{\pi}{6} - \min.$$

$$b) y = 2\sin x - x, \quad x \in [\pi; 3\pi]; \quad y' = 2\cos x - 1;$$

$$\cos x = \frac{1}{2}; \quad x = \pm \frac{\pi}{3} + 2\pi n; \quad x = \frac{5\pi}{3} - \min; \quad x = \frac{7\pi}{3} - \max.$$

§ 31. Построение графиков функций

31.1. a)

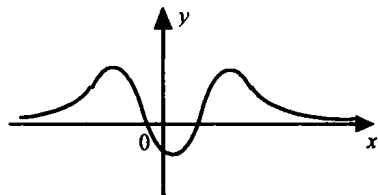

б)

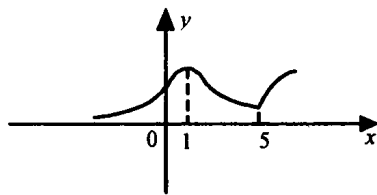

31.2.

а)

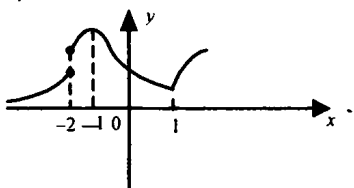

б)

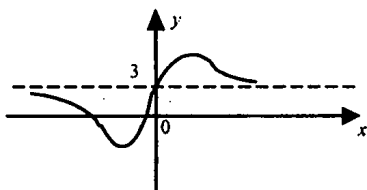

31.3.

а) $y = 3x^2 - 4x + 5$;

$y' = 6x - 4$;

$x = \frac{2}{3} - \text{min}$,

$y\left(\frac{2}{3}\right) = \frac{11}{3}$

при $x \geq \frac{2}{3}$ функция возрастает,при $x \leq \frac{2}{3}$ функция убывает

пересечение с Oy: (0;5)

с Ox: нет

 $y > 0$ при $x \in \mathbb{R}$

б) $y = 3 + 2x - x^2$;

$y' = 2 - 2x$;

$x = 1 - \text{min}$,

$y(1) = 4$

при $x \geq 1$ функция убывает,при $x \leq 1$ функция возрастает

пересечение с Oy: (0;3)

с Ox: (3;0), (-1;0)

 $y > 0$ при $x \in (-1; 3)$, $y < 0$ при $x < -1$, $x > 3$

в) $y = 7 - x - 2x^2$; $y' = -1 - 4x$;

$x = -\frac{1}{4} - \text{max}$, $y\left(-\frac{1}{4}\right) = \frac{57}{8}$

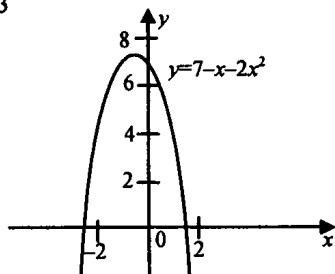
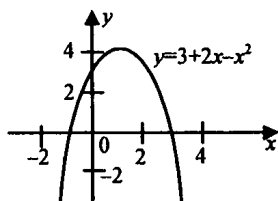
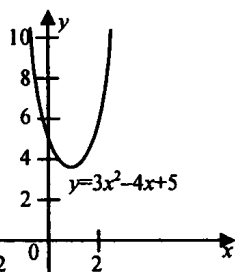
при $x \geq -\frac{1}{4}$ функция убываетпри $x \leq -\frac{1}{4}$ функция возрастает

пересечение с Oy: (0;7)

$$\text{с Ox: } \left(\frac{-1-\sqrt{57}}{4}; 0 \right), \left(\frac{-1+\sqrt{57}}{4}; 0 \right);$$

$$y > 0, \text{ при } x \in \left(\frac{-1-\sqrt{57}}{4}; \frac{-1+\sqrt{57}}{4} \right)$$

$$y < 0 \text{ при } x \in \left(-\infty; \frac{-1-\sqrt{57}}{4} \right), \left(\frac{-1+\sqrt{57}}{4}; +\infty \right)$$

$$\text{г) } y = 5x^2 - 15x - 4; \quad y' = 10x - 15;$$

$$x = \frac{3}{2} - \min$$

при $x \geq \frac{3}{2}$ функция возрастает,

при $x \leq \frac{3}{2}$ функция убывает

пересечение с Oy: (0; -4)

$$\text{с Ox: } \left(\frac{15-\sqrt{305}}{10}; 0 \right), \left(\frac{15+\sqrt{305}}{10}; 0 \right)$$

функция $y > 0$ при $x < \frac{15-\sqrt{305}}{10}$, $x > \frac{15+\sqrt{305}}{10}$

$$y < 0 \text{ при } x \in \left(\frac{15-\sqrt{305}}{10}; \frac{15+\sqrt{305}}{10} \right).$$

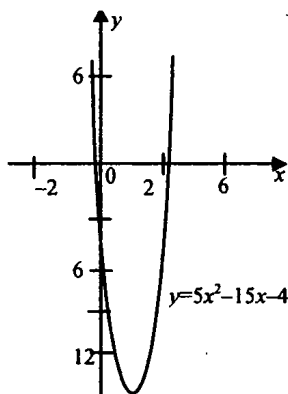

$$\text{31.4. а) } y = 3x^2 - x^3;$$

$$y' = 6x - 3x^2;$$

$$x = 0, x = 2$$

$$y(0) = 0 \quad y(2) = 12 - 8 = 4,$$

$$x = 0 - \min, \quad x = 2 - \max,$$

при $x \in [0; 2]$ функция возрастает,

при $x \leq 0, x \geq 2$ функция убывает.

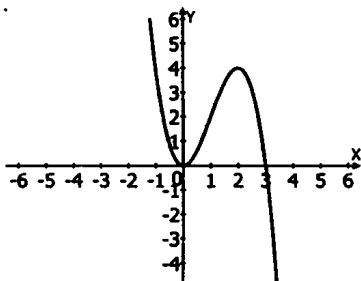

$$\text{б) } y = -9x + x^3;$$

$$y' = -9 + 3x^2;$$

$$x^2 = 3; \quad x = \pm\sqrt{3};$$

$$y(\sqrt{3}) = -9\sqrt{3} + 3\sqrt{3}; \quad y(-\sqrt{3}) = 9\sqrt{3} - 3\sqrt{3}.$$

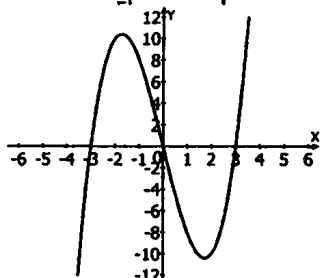

$$x = \sqrt{3} - \text{min}, \quad x = -\sqrt{3} - \text{max},$$

при $x \leq -\sqrt{3}, x \geq \sqrt{3}$ функция возрастает,

при $x \in [-\sqrt{3}; \sqrt{3}]$ функция убывает.

$$\text{в) } y = x^3 + 3x^2;$$

$$y' = 3x^2 + 6x;$$

$$x = 0, x = -2,$$

$$y(0) = 0; \quad y(-2) = -8 + 12 = 4$$

$$x = 0 - \text{min}, \quad x = -2 - \text{max};$$

при $x \in [-2; 0]$ функция убывает,

при $x \leq -2, x \geq 0$ функция возрастает

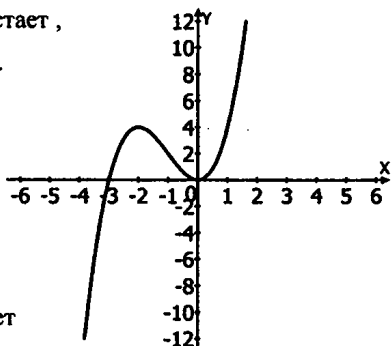

$$\text{г) } y = 3x - x^3; \quad y' = 3 - 3x^2;$$

$$x = \pm 1,$$

$$y(1) = 3 - 1 = 2$$

$$y(-1) = -3 + 1 = -2$$

$$x = 1 - \text{max}, \quad x = -1 - \text{min};$$

при $x \in [-1; 1]$ функция возрастает,

при $x \leq -1, x \geq 1$ функция убывает

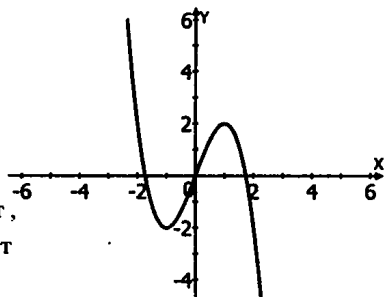

$$\text{31.5. а) } y = x^3 - 3x^2 + 2;$$

$$y' = 3x^2 - 6x$$

$$x = 0, x = 2;$$

$$y(0) = 2; \quad y(2) = 8 - 12 + 2 = -2$$

$$x = 0 - \text{max}, \quad x = 2 - \text{min},$$

при $x \in [0; 2]$ функция убывает,

при $x \leq 0, x \geq 2$ функция возрастает

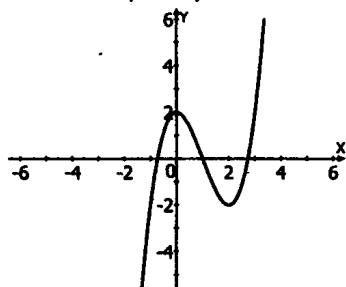

$$\text{б) } y = -x^3 + 3x - 2;$$

$$y' = -3x^2 + 3;$$

$$x = \pm 1$$

$$y(1) = -1 + 3 - 2 = 0$$

$$y(-1) = 1 - 3 - 2 = -4$$

$$x = 1 - \text{max}, \quad x = -1 - \text{min}$$

при $x \in [-1; 1]$ функция возрастает,

при $x \leq -1, x \geq 1$ функция убывает

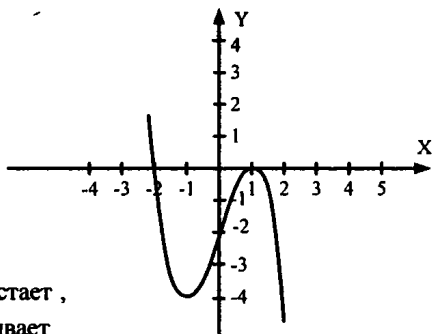

$$в) y = -x^3 + 6x^2 - 5;$$

$$y' = -3x^2 + 12x = -x^2 + 4x,$$

$$x = 0, \quad x = 4,$$

$$x = 0 - \text{min}, \quad x = 4 - \text{max},$$

при $x \in [0; 4]$ функция возрастает,

при $x \leq 0, x \geq 4$ функция убывает

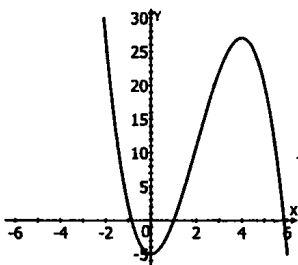

$$г) y = x^3 - 3x + 2;$$

$$y' = 3x^2 - 3;$$

$$x = \pm 1;$$

$$x = 1 - \text{min}, \quad x = -1 - \text{max}$$

при $x \in [-1; 1]$ функция убывает,

при $x \leq -1, x \geq 1$ функция возрастает

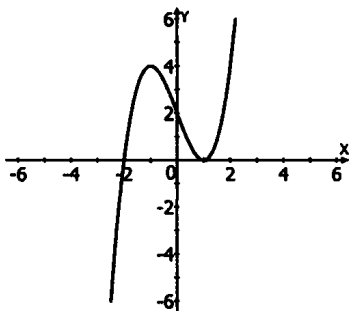

31.6.

$$а) y = 2x^3 + x^2 - 8x - 7;$$

$$y' = 6x^2 + 2x - 8;$$

$$x = \frac{-1-7}{6} = -\frac{4}{3}, \quad x = 1,$$

$$x = -\frac{4}{3} - \text{max}, \quad x = 1 - \text{min},$$

при $x \in \left[-\frac{4}{3}; 1\right]$ функция убывает,

при $x \leq -\frac{4}{3}, x \geq 1$ функция возрастает.

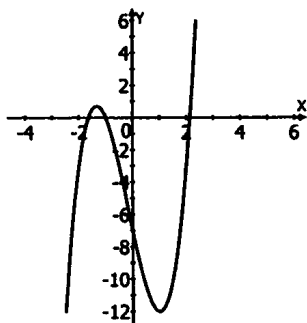

$$б) y = -\frac{x^3}{3} + x^2 + 3x - \frac{11}{3};$$

$$y' = -x^2 + 2x + 3;$$

$$x = 3, \quad x = -1;$$

$$x = -1 - \text{min}, \quad x = 3 - \text{max}$$

при $x \in [-1; 3]$ функция возрастает,

при $x \leq -1, x \geq 3$ функция убывает.

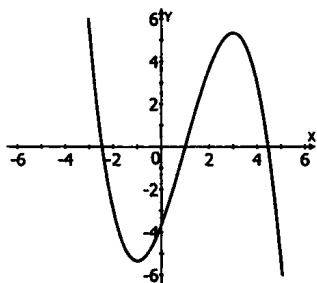

$$в) y = x^3 + x^2 - x - 1;$$

$$y' = 3x^2 + 2x - 1;$$

$$x = \frac{-1-2}{3} = -1, x = \frac{1}{3};$$

$$x = \frac{1}{3} - \text{min}, x = -1 - \text{max};$$

при $x \in \left[-1; \frac{1}{3}\right]$ функция убывает,

при $x \leq -1, x \geq \frac{1}{3}$ функция возрастает.

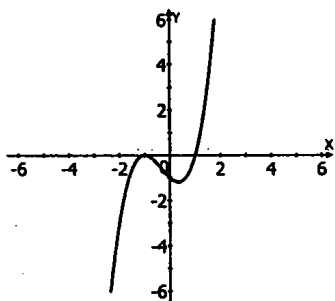

$$г) y = \frac{x^3}{3} + x^2 - 3x + \frac{5}{3},$$

$$y' = x^2 + 2x - 3,$$

$$x = -3, x = 1$$

$$x = -1 - \text{min}, x = -3 - \text{max}$$

при $x \in [-3; 1]$ функция убывает,

при $x \leq -3, x \geq 1$ функция возрастает.

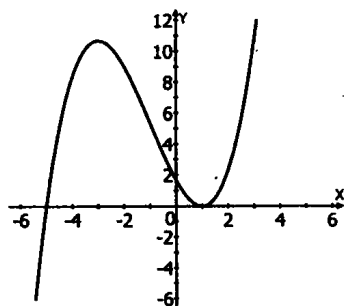

31.7.

$$а) y = -x^4 + 5x^2 - 4,$$

$$y' = -4x^3 + 10x,$$

$$y = (x-1)^2(x+2),$$

$$x = 0, x = \sqrt{\frac{5}{2}}, x = -\sqrt{\frac{5}{2}};$$

$$x = 0 - \text{min}, x = \pm\sqrt{\frac{5}{2}} - \text{max}$$

$$\text{при } x \in \left(-\infty; -\sqrt{\frac{5}{2}}\right] \cup \left[0; \sqrt{\frac{5}{2}}\right]$$

функция возрастает.

$$\text{при } x \in \left[-\sqrt{\frac{5}{2}}; 0\right] \cup \left[\sqrt{\frac{5}{2}}; +\infty\right)$$

функция убывает.

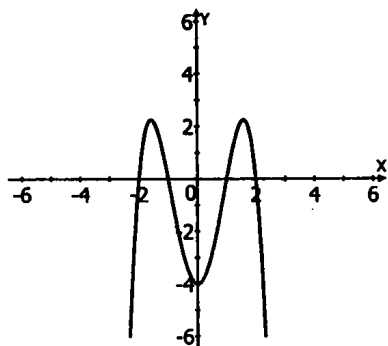

$$б) y = x^5 - 5x;$$

$$y' = 5x^4 - 5;$$

$$x^4 - 1 = 0; \quad x = \pm 1;$$

$$x = 1 - \text{min}, \quad x = -1 - \text{max};$$

при $x \in [-1; 1]$ функция убывает,

при $x \leq -1, x \geq 1$ функция возрастает.

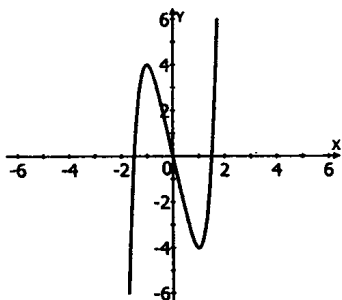

$$в) y = 2x^4 - 9x^2 + 7;$$

$$y' = 8x^3 - 18x;$$

$$2x(4x^2 - 9) = 0;$$

$$x = 0, \quad x = \pm \frac{3}{2};$$

$$x = 0 - \text{max}, \quad x = \pm \frac{3}{2} - \text{min};$$

при $x \in \left(-\infty; -\frac{3}{2}\right) \cup \left[0; \frac{3}{2}\right]$ функция убывает,

при $x \in \left[-\frac{3}{2}; 0\right) \cup \left[\frac{3}{2}; +\infty\right)$ функция возрастает.

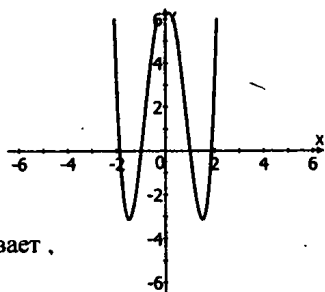

$$г) y = 5x^3 - 3x^5,$$

$$y' = 15x^2 - 15x^4,$$

$$15x^2(1 - x^2) = 0,$$

$$x = 0, \quad x = \pm 1,$$

$$x = 1 - \text{max}, \quad x = -1 - \text{min},$$

при $x \in [-1; 1]$ функция возрастает,

при $x \in (-\infty; -1] \cup [1; +\infty)$ функция убывает.

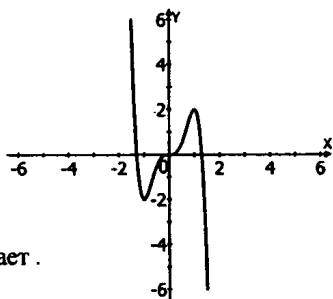

31.8.

$$а) y = (x-1)^2(x+2),$$

$$y' = 2(x-1)(x+2) + (x-1)^2 =$$

$$= (x-1)(2x+4+x-1) =$$

$$= (x-1)(3x+3) = 0$$

$$(x-1)(x+1) = 0,$$

$$x = 1, \quad x = -1,$$

$$x = -1 - \text{max}, \quad x = 1 - \text{min},$$

при $x \in [-1; 1]$ функция убывает,

при $x \leq -1, x \geq 1$ функция возрастает

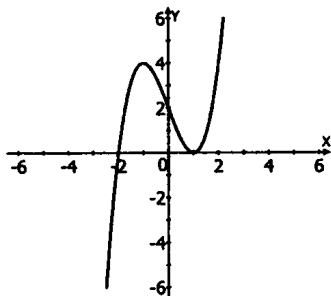

$$б) y = \frac{256}{9}x(x-1)^3$$

$$y' = \frac{256}{9}((x-1)^3 + 3(x-1)^2x) =$$

$$= \frac{256}{9}(x-1)^2(4x-1);$$

$$\frac{256}{9}(x-1)^2(4x-1) = 0;$$

$$x = 1, \quad x = \frac{1}{4},$$

$$x = \frac{1}{4} - \text{min},$$

при $x \geq \frac{1}{4}$ функция возрастает.

при $x \leq \frac{1}{4}$ функция убывает

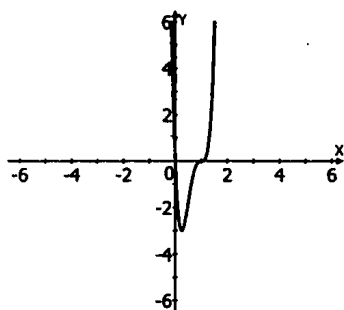

$$в) y = (x+2)^2(x-3),$$

$$y' = 2(x+2)(x-3) + (x+2)^2 =$$

$$= (x+2)(3x-4)$$

$$(x+2)(3x-4) = 0, \quad x = -2, \quad x = \frac{4}{3},$$

$$x = -2 - \text{max}, \quad x = \frac{4}{3} - \text{min},$$

при $x \in \left[-2; \frac{4}{3}\right]$ функция убывает,

при $x \leq -2, x \geq \frac{4}{3}$ функция возрастает.

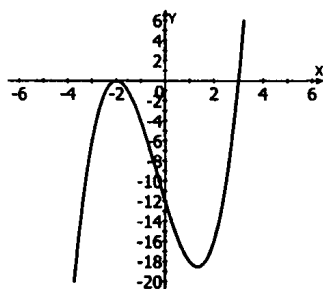

$$г) y = x^3(2-x),$$

$$y' = (3x^2(2-x) - x^3) = x^2(6-4x),$$

$$x^2(6-4x) = 0,$$

$$x = 0, \quad x = \frac{3}{2},$$

$$x = \frac{3}{2} - \text{max},$$

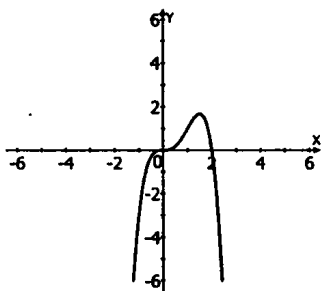

при $x \geq \frac{3}{2}$ функция убывает, при $x \leq \frac{3}{2}$ функция возрастает.

31.9. а)

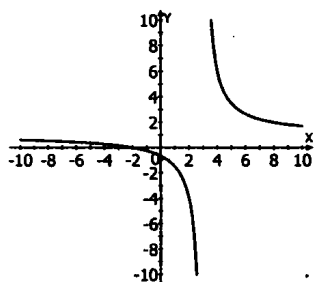

$$б) y = \frac{3x-4}{x-2} = 3 + \frac{2}{x-2}$$

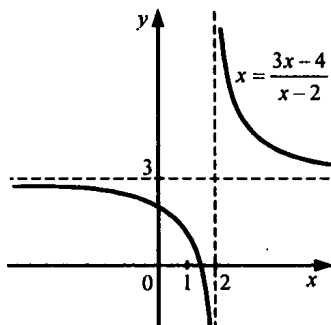

в)

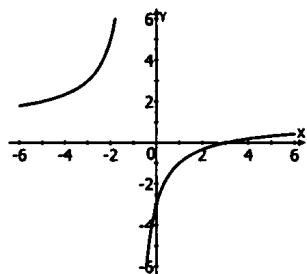

$$г) y = \frac{2x+1}{x+2} = 2 - \frac{3}{x+2}$$

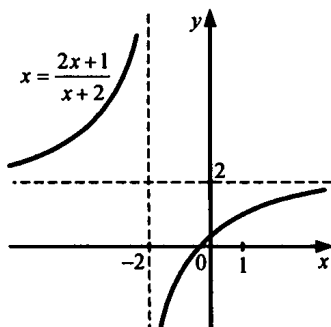

В задачах 31.10–31.12 для исследования функции на возрастание и убывание будем исследовать ее производную. На промежутках, где $y' \geq 0$, функция возрастает, а где $y' \leq 0$ функция убывает.

31.10. а)

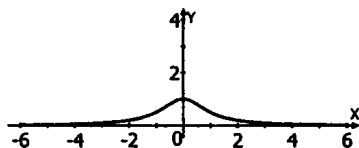

$$y = \frac{1}{x^2+1}, \quad y' = -\frac{2x}{(x^2+1)^2}$$

$y' < 0$ при $x > 0$, $y' > 0$ при $x < 0$, асимптота $-y = 0$, $x = 0$ — \max
 $x \in (-\infty; 0]$ — возрастает $x \in [0; +\infty)$ — убывает.

6)

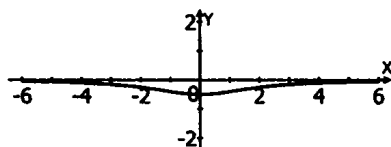

$$y = -\frac{2}{x^2 + 4}, \quad y' = \frac{4x}{(x^2 + 4)^2},$$

$y' < 0$ при $x < 0$, $y' > 0$ при $x > 0$, асимптота $-y = 0$, $x = 0$ — min.
 $x \in (-\infty; 0]$ — убывает $x \in [0; +\infty)$ — возрастает.

31.11. а)

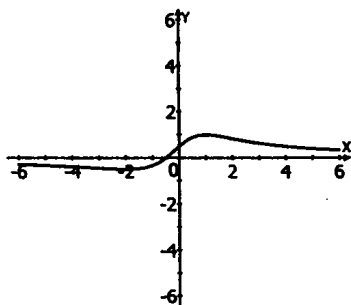

$$y = \frac{2x+1}{x^2+2}, \quad y' = \frac{2x^2+4-4x^2-2x}{(x^2+2)^2} = \frac{-2x^2-2x+4}{(x^2+2)^2},$$

$y' > 0$ при $x^2+x-2 < 0$ $(x+2)(x-1) < 0$

$x \in [-2; 1]$ — возрастает $x \in (-\infty; -2] \cup [1; +\infty)$ — убывает
 асимптота $-y = 0$.

б)

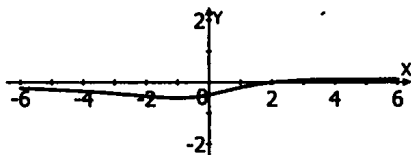

$$y = \frac{x-2}{x^2+5}, \quad y' = \frac{x^2+5-2x^2+4x}{(x^2+5)^2} = \frac{-x^2+4x+5}{(x^2+5)^2},$$

$y' > 0$ при $x^2-4x-5 < 0$; $-1 < x < 5$

при $x \in [-1; 5]$ — возрастает, при $x \leq -1, x \geq 5$ — убывает

$x = -1$ — min, $x = 5$ — max, асимптота $-y = 0$.

31.12.

а)

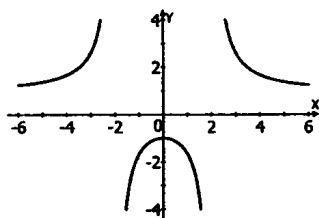

$$y = \frac{x^2 + 4}{x^2 - 4}, \quad y' = \frac{2x^3 - 8x - 2x^3 - 8x}{(x^2 - 4)^2} = \frac{-16x}{(x^2 - 4)^2},$$

$x \in [0; 2) \cup (2; +\infty)$ — убывает

$x \in (-\infty; -2) \cup (-2; 0]$ — возрастает

$x = 0$ — макс, асимптоты: $y = 0$; $x = \pm 2$.

б)

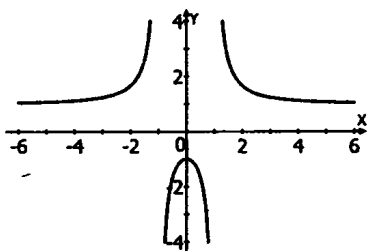

$$y = \frac{x^2 + 1}{x^2 - 1}, \quad y' = \frac{2x^3 - 2x - 2x^3 - 2x}{(x^2 - 1)^2} = \frac{-4x}{(x^2 - 1)^2},$$

$x \in [0; 1) \cup (1; +\infty)$ — убывает

$x \in (-\infty; -1) \cup (-1; 0]$ — возрастает

$x = 0$ — макс, асимптоты: $y = 0$; $x = \pm 1$.

31.13. а)

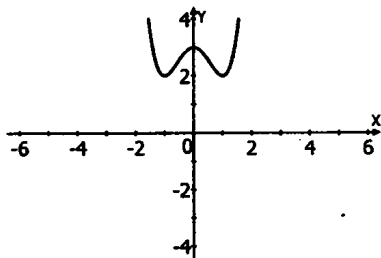

б) Количество корней в данном уравнении – это количество пересечений графиков $y = x^4 - 2x^2 + 3$ и $y = a$.

Из рисунка видно, что такой случай имеет место, когда прямая $y = a$ касается графика функции в точке $(0; y(0))$ $y(0) = 3$, следовательно, $a = 3$.
31.14. а)

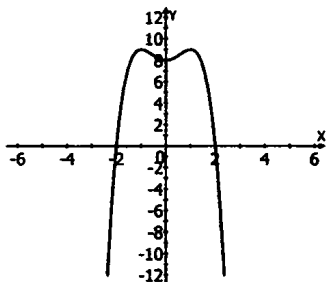

б) Чтобы уравнение не имело корней, необходимо, чтобы прямая лежала выше графика функции $y = -x^4 + 2x^2 + 8$.

Найдем точки максимума: $y' = -4x^3 + 4x = 4x(1 - x^2) = 0$,
 $x = 0$ – точка минимума, $x = \pm 1$ – точки максимума,
 $y(1) = y(-1) = -1 + 2 + 8 = 9$.
 Следовательно, $a > 9$.

31.15.

а)
 $y' = 3x^2 - 3x = 1$ – min,
 $x = -1$ – max, $y(1) = -2$, $y(-1) = 2$
 при $|a| > 2$

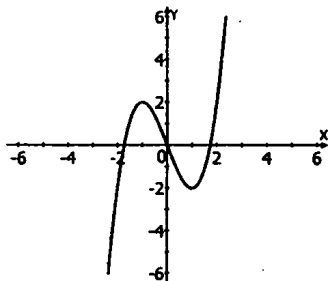

б)
 $y' = 3 - 3x^2$, $x = 1$ – max
 $x = -1$ – min, $y(1) = 2$, $y(-1) = -2$
 $a = -2$ и $a = 2$.

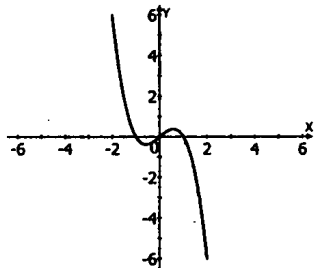

**§ 32. Применение производной для нахождения
наибольших и наименьших значений**

32.1. а) $y = 3x - 6$, $x \in [-1; 4]$

$y' = 3 \Rightarrow$ функция растет на

$x_{\min} = -1$, $y(-1) = -9$, $y_{\min} = -9$;

$x_{\max} = 4$, $y(4) = 6$, $y_{\max} = 6$.

б) $y = -\frac{8}{x}$, $x \in \left[\frac{1}{4}; 8\right]$

$y' = \frac{8}{x^2} > 0 \Rightarrow$ функция растет при $x \in \left[\frac{1}{4}; 8\right]$

$x_{\min} = \frac{1}{4}$, $y\left(\frac{1}{4}\right) = -32$, $y_{\min} = -32$

$x_{\max} = 8$, $y(8) = -1$, $y_{\max} = -1$.

в) $y = -\frac{1}{2}x + 4$, $x \in [-2; 6]$

$y' = -\frac{1}{2} \Rightarrow$ функция убывает на \mathbb{R}

$x_{\min} = 6$, $y(6) = 1$, $y_{\min} = 1$;

$x_{\max} = -2$, $y(-2) = 5$, $y_{\max} = 5$

г) $y = \frac{3}{x}$, $x \in [0,3; 2]$

$y' = -\frac{3}{x^2} < 0 \Rightarrow$ функция убывает при $[0,3; 2]$

$x_{\max} = 0,3$, $y(0,3) = 10$, $y_{\max} = 10$;

$x_{\min} = 2$, $y(2) = \frac{3}{2}$, $y_{\min} = \frac{3}{2}$.

32.2. а) $y = 2\sin x$, $x \in \left[-\frac{\pi}{2}; \pi\right]$; $y' = 2\cos x$;

$x = -\frac{\pi}{2}$, $x = \frac{\pi}{2}$; $y_{\max} = 2$, $y_{\min} = -2$.

б) $y = -2\cos x$, $x \in \left[-2\pi; -\frac{\pi}{2}\right]$ $y_{\max} = 2$, $y_{\min} = -2$.

в) $y = 6\cos x$, $x \in \left[-\frac{\pi}{2}; 0\right]$; $y_{\max} = 6$, $y_{\min} = 0$.

$$г) y = -\frac{1}{2} \sin x, \quad x \in \left[-\frac{\pi}{2}; \frac{\pi}{2}\right]; \quad y_{\max} = \frac{1}{2}, \quad y_{\min} = -\frac{1}{2}.$$

$$32.3. а) y = \operatorname{tg} x, \quad x \in \left[-\frac{\pi}{3}; -\frac{\pi}{6}\right]; \quad y_{\max} = -\frac{\sqrt{3}}{3}, \quad y_{\min} = -\sqrt{3}.$$

$$б) y = -3 \operatorname{tg} x, \quad x \in \left[\pi; \frac{4\pi}{3}\right]; \quad y_{\min} = -3\sqrt{3}, \quad y_{\max} = 0.$$

$$в) y = -2 \operatorname{tg} x, \quad x \in \left[0; \frac{\pi}{6}\right]; \quad y_{\max} = 0, \quad y_{\min} = -\frac{2\sqrt{3}}{3}.$$

$$г) y = \frac{1}{2} \operatorname{tg} x, \quad x \in \left[-\pi; -\frac{3\pi}{4}\right]; \quad y_{\max} = \frac{1}{2}, \quad y_{\min} = 0.$$

$$32.4. а) y = \sqrt{x}, \quad x \in [0; 9]; \quad y_{\max} = 3, \quad y_{\min} = 0.$$

$$б) y = \sqrt{-x}, \quad x \in [-4; 0]; \quad y_{\max} = 2, \quad y_{\min} = 0.$$

$$в) y = -\sqrt{x}, \quad x \in [4; 16]; \quad y_{\max} = -2, \quad y_{\min} = -4.$$

$$г) y = -\sqrt{-x}, \quad x \in [-9; -4]; \quad y_{\max} = -2, \quad y_{\min} = -3.$$

$$32.5. а) y = 12x^4, \quad x \in [-1; 2]; \quad y_{\max} = 192, \quad y_{\min} = 0.$$

$$б) y = -6x^5, \quad x \in [0; 1; 2] \quad y_{\max} = -\frac{6}{100000} = -\frac{3}{50000}, \quad y_{\min} = -192.$$

$$в) y = -3x^7, \quad x \in [0; 1]; \quad y_{\max} = 0, \quad y_{\min} = -3.$$

$$г) y = \frac{x^4}{9}, \quad x \in [-1; 3]; \quad y_{\max} = 9, \quad y_{\min} = 0.$$

$$32.6. а) y = x^2 - 8x + 19, \quad x \in [-1; 5]$$

$$y' = 2x - 8, \quad x = 4 \text{ — точка минимума;}$$

$$y(4) = 16 - 32 + 19 = 3; \quad y(-1) = 1 + 8 + 19 = 28;$$

$$y(5) = 25 - 40 + 19 = 4;$$

$$y_{\max} = 28, \quad y_{\min} = 3.$$

$$б) y = x^2 + 4x - 3, \quad x \in [0; 2]$$

$$y' = 2x + 4, \quad x = -2, \quad -2 \notin [0; 2]$$

$$y(0) = -3, \quad y(2) = 4 + 8 - 3 = 9;$$

$$y_{\max} = 9, \quad y_{\min} = -3$$

$$в) y = 2x^2 - 8x + 6, \quad x \in [-1; 4]$$

$$y' = 4x - 8, \quad x = 2; \quad y(2) = 8 - 16 + 6 = -2;$$

$$y(-1) = 2 + 8 + 6 = 16; \quad y(4) = 32 - 32 + 6 = 6;$$

$$y_{\max} = 16, \quad y_{\min} = -2.$$

$$\text{r)} \quad y = -3x^2 + 6x - 10, \quad x \in [-2; 9]; \quad y' = -6x + 6, \quad x = 1;$$

$$y(1) = -3 + 6 - 10 = -7; \quad y(-2) = -12 - 12 - 10 = -34$$

$$y(9) = -243 + 54 - 10 = -199;$$

$$y_{\max} = -7, \quad y_{\min} = -199.$$

$$32.7. \quad y = \sin x;$$

$$\text{a)} \quad \left[0; \frac{2\pi}{3}\right]; \quad y_{\max} = 1, \quad y_{\min} = 0.$$

$$\text{б)} \quad \left[2\pi; \frac{8\pi}{3}\right]; \quad y_{\max} = 1, \quad y_{\min} = 0.$$

$$\text{в)} \quad \left[-2\pi; -\frac{4\pi}{3}\right]; \quad y_{\max} = 1, \quad y_{\min} = 0.$$

$$\text{г)} \quad \left[6\pi; \frac{26\pi}{3}\right]; \quad y_{\max} = 1, \quad y_{\min} = -1.$$

$$32.8.$$

$$y = x^3 - 9x^2 + 24x - 1; \quad y' = 3x^2 - 18x + 24 = 0;$$

$$x^2 - 6x + 8 = 0; \quad x = 4, \quad x = 2;$$

$$y_{\max} = y(2) = 8 - 36 + 48 - 1 = 19;$$

$$y_{\min} = y(4) = 64 - 144 + 96 - 1 = 15.$$

$$\text{a)} \quad [-1; 3];$$

$$y_{\max} = y(2) = 19; \quad y_{\min} = y(-1) = -1 - 9 - 24 - 1 = -35.$$

$$\text{б)} \quad [3; 6];$$

$$y(3) = 27 - 81 + 72 - 1 = 17; \quad y(6) = 35; \quad y_{\max} = 35; \quad y_{\min} = 15.$$

$$\text{в)} \quad [-2; 3];$$

$$y_{\max} = y(2) = 19, \quad y_{\min} = y(-2) = -8 - 36 - 48 - 1 = -93.$$

$$\text{г)} \quad [3; 5];$$

$$y_{\max} = y(5) = 125 - 225 + 120 - 1 = 19, \quad y_{\min} = y(4) = 15.$$

$$32.9. \quad y = x^3 + 3x^2 - 45x - 2; \quad y' = 3x^2 + 6x - 45 = 0;$$

$$x^2 + 2x - 15 = 0; \quad x = -5, \quad x = 3;$$

$$y_{\max} = y(-5) = -125 + 75 + 225 - 2 = 173,$$

$$y_{\min} = y(3) = 27 + 27 - 135 - 2 = -79.$$

$$\text{a)} \quad [-6; 0]; \quad y_{\max} = 173; \quad y_{\min} = -2.$$

$$\text{б) } [1; 2]; \quad y_{\max} = -43, \quad y_{\min} = -72.$$

$$\text{в) } [-6; -1]; \quad y_{\max} = 173, \quad y_{\min} = 45.$$

$$\text{г) } [0; 2]; \quad y_{\max} = -2, \quad y_{\min} = -72.$$

$$32.10. \quad y = x^3 - 9x^2 + 15x - 3; \quad y' = 3x^2 - 18x + 15 = 0;$$

$$x^2 - 6x + 5 = 0; \quad x = 5, \quad x = 1;$$

$$y_{\max} = y(1) = 1 - 9 + 15 - 3 = 4,$$

$$y_{\min} = y(5) = 125 - 225 + 75 - 3 = -28.$$

$$\text{а) } [0; 2]; \quad y_{\max} = 4, \quad y_{\min} = -3.$$

$$\text{б) } [3; 6]; \quad y_{\max} = -12, \quad y_{\min} = -28.$$

$$\text{в) } [-1; 3]; \quad y_{\max} = 4, \quad y_{\min} = -28.$$

$$\text{г) } [2; 7]; \quad y_{\max} = 4, \quad y_{\min} = -28.$$

$$32.11. \quad y = x^4 - 8x^3 + 10x^2 + 1;$$

$$y' = 4x^3 - 24x^2 + 20x = 0;$$

$$4x(x^2 - 6x + 5) = 0; \quad x = 0, \quad x = 5, \quad x = 1; \quad y(0) = 1,$$

$$y_{\max} = y(1) = 1 - 8 + 10 + 1 = 4,$$

$$y_{\min} = y(5) = 625 - 1000 + 250 + 1 = -124.$$

$$\text{а) } [-1; 2]; \quad y_{\max} = 20, \quad y_{\min} = -7.$$

$$\text{б) } [1; 6]; \quad y_{\max} = 4, \quad y_{\min} = -124.$$

$$\text{в) } [-2; 3]; \quad y_{\max} = 121, \quad y_{\min} = -44.$$

$$\text{г) } [-1; 7]; \quad y_{\max} = 148, \quad y_{\min} = -124.$$

$$32.12. \quad y = x + \frac{4}{x-1};$$

$$y' = 1 - \frac{4}{(x-1)^2} = 0; \quad (x-1)^2 = 4; \quad x = -1, \quad x = 3;$$

$$y_{\min} = y(3) = 3 + 2 = 5, \quad y_{\max} = y(-1) = -1 + \frac{4}{-2} = -1 - 2 = -3.$$

$$\text{а) } [2; 4]; \quad y_{\max} = 6, \quad y_{\min} = 5.$$

$$\text{б) } [-2; 0]; \quad y_{\max} = -3, \quad y_{\min} = -4.$$

$$32.13. \text{ а) } y = \operatorname{ctg} x + x \quad x \in \left[\frac{\pi}{4}; \frac{3\pi}{4} \right];$$

$$y' = -\frac{1}{\sin^2 x} + 1 \leq 0;$$

$$y_{\max} = 1 + \frac{\pi}{4}, \quad y_{\min} = -1 + \frac{3\pi}{4}.$$

$$y \in [y_{\min}, y_{\max}]$$

$$б) y = 2 \sin x - x \quad x \in [0; \pi];$$

$$y' = 2 \cos x - 1;$$

$$x = \pm \frac{\pi}{3} + \pi n, \quad x = \frac{\pi}{3}; \quad y_{\max} = y\left(\frac{\pi}{3}\right) = \sqrt{3} - \frac{\pi}{3}; \quad y_{\min} = -\pi.$$

$$y \in [y_{\min}, y_{\max}]$$

$$в) y = 2 \cos x + x, \quad x \in \left[-\frac{\pi}{2}; \frac{\pi}{2}\right];$$

$$y' = -2 \sin x + 1; \quad \sin x = \frac{1}{2}; \quad x = \frac{\pi}{6};$$

$$y_{\max} = y\left(\frac{\pi}{6}\right) = \sqrt{3} + \frac{\pi}{6}; \quad y_{\min} = -\frac{\pi}{2}.$$

$$y \in [y_{\min}, y_{\max}]$$

$$г) y = \operatorname{tg} x - x \quad x \in \left[0; \frac{\pi}{3}\right]; \quad y' = \frac{1}{\cos^2 x} - 1;$$

$$x = \pi n, \quad x = 0; \quad y_{\max} = y\left(\frac{\pi}{3}\right) = \sqrt{3} - \frac{\pi}{3}; \quad y_{\min} = y(0) = 0.$$

$$y \in [y_{\min}, y_{\max}]$$

$$32.14. а) y = x^3 - 2x^2 + 1, \quad [0, 5; +\infty);$$

$$y' = 3x^2 - 4x = 0; \quad x(3x - 4) = 0;$$

$$x = 0, \quad x = \frac{4}{3};$$

$$y_{\max} \text{ не существует}; \quad y_{\min} = y\left(\frac{4}{3}\right) = \frac{64}{27} - \frac{32}{9} + 1 = -\frac{5}{27}.$$

$$б) y = x - 2\sqrt{x}, \quad [0; +\infty); \quad y' = 1 - \frac{1}{\sqrt{x}}; \quad x = 1;$$

$$y_{\max} \text{ не существует}, \quad y_{\min} = y(1) = 1 - 2 = -1.$$

$$в) y = \frac{1}{5}x^5 - x^2, \quad (-\infty; 1]; \quad y' = x^4 - 2x = 0; \quad x(x^3 - 2) = 0;$$

$$x = 0, \quad x = \sqrt[3]{2};$$

$$y_{\max} = y(0) = 0; \quad y_{\min} \text{ не существует};$$

$$г) y = \frac{x^4}{x^4 + 1} = 1 - \frac{1}{x^4 + 1}, \quad x \in \mathbb{R};$$

$$y' = \frac{4x^3}{(x^4 + 1)^2} = 0,$$

y_{\max} не существует.; $y_{\min} = y(0) = 0$.

32.15. а) $y = x + \frac{1}{x}$, $(-\infty; 0)$; $y' = 1 - \frac{1}{x^2}$; $x = \pm 1$;

$y_{\max} = y(-1) = -1 - 1 = -2$; y_{\min} не существует;

б) $y = \frac{3x}{x^2 + 3}$, $[0; +\infty)$; $y' = \frac{3x^2 + 9 - 6x^2}{(x^2 + 3)^2} = -3 \cdot \frac{x^2 - 3}{x^2 + 3}$; $x = \pm\sqrt{3}$.

$y_{\max} = y(\sqrt{3}) = \frac{3\sqrt{3}}{3+3} = \frac{\sqrt{3}}{2}$; $y_{\min} = y(0) = 0$.

в) $y = -2x - \frac{1}{2x}$, $(0; +\infty)$; $y' = -2 + \frac{1}{2x^2} = 0$; $4x^2 = 1$; $x = \pm\frac{1}{2}$;

$y_{\max} = y\left(\frac{1}{2}\right) = -1 - 1 = -2$; y_{\min} не существует..

г) $y = \sqrt{2x+6} - x$, $[-3; +\infty)$; $y' = \frac{1}{\sqrt{2x+6}} - 1 = 0$; $\sqrt{2x+6} = 1$;

$x = -\frac{5}{2}$; $y_{\max} = y\left(-\frac{5}{2}\right) = 1 + \frac{5}{2} = 3,5$, y_{\min} не существует.

32.16. а) $y = x^2 - 4x + 5 + |1 - x|$, $[0; 4]$;

1) $x \geq 1$; $y = x^2 - 3x + 4$; $y' = 2x - 3 = 0$; $x = \frac{3}{2}$;

$y(1) = 1 - 4 + 5 + (1 - 1) = 2$;

$y\left(\frac{3}{2}\right) = \frac{9}{4} - 6 + 5 + \left(1 - \frac{3}{2}\right) = \frac{7}{4}$;

$y(4) = 8$;

2) $x \leq 1$; $y = x^2 - 5x + 6$;

$y' = 2x - 5 = 0$; $x = \frac{5}{2}$ — не подходит; $y(0) = 6$;

$y_{\min} = \frac{7}{4}$; $y_{\max} = 8$.

б) $y = |x^3 - 1| - 3x$, $[-1; 3]$;

1) $x \geq 1$; $y = x^3 - 3x - 1$; $y' = 3x^2 - 3$; $x = 1$; $y(1) = -3$; $y(3) = 17$;

2) $x \leq 1$; $y = 1 - 3x - x^3$; $y' = -3 - 3x^2$; $y(1) = -3 = y_{\min}$; $y(-1) = 5$;

$y_{\min} = -3$; $y_{\max} = 17$.

$$32.17. a) y = 2x - \sqrt{16x-4}, \quad x \in \left[\frac{1}{4}; \frac{17}{4} \right];$$

$$y' = 2 - \frac{8}{\sqrt{16x-4}}; \quad x = \frac{5}{4}; \quad y\left(\frac{5}{4}\right) = \frac{5}{2} - 4 = -\frac{3}{2};$$

$$y\left(\frac{1}{4}\right) = \frac{1}{2}; \quad y\left(\frac{17}{4}\right) = \frac{17}{2} - 8 = \frac{1}{2}; \quad y \in \left[-\frac{3}{2}; \frac{1}{2} \right].$$

$$b) y = 2\sqrt{x-1} - \frac{1}{2}x, \quad x \in [1; 10];$$

$$y' = \frac{1}{\sqrt{x-1}} - \frac{1}{2}; \quad x = 5;$$

$$y(5) = 4 - \frac{5}{2} = \frac{3}{2}; \quad y(1) = -\frac{1}{2}; \quad y(10) = 6 - 5 = 1; \quad y \in \left[-\frac{1}{2}; \frac{3}{2} \right].$$

$$32.18. a) y = x\sqrt{x+2};$$

$$y' = \sqrt{x+2} + \frac{x}{2\sqrt{x+2}} = \frac{2x+4+x}{2\sqrt{x+2}} = \frac{3x+4}{2\sqrt{x+2}};$$

$$x = -\frac{4}{3}; \quad y\left(-\frac{4}{3}\right) = -\frac{4}{3} \cdot \sqrt{-\frac{4}{3}+2} = -\frac{4\sqrt{6}}{9}; \quad y \in \left[-\frac{4}{9}\sqrt{6}; +\infty \right).$$

$$b) y = x\sqrt{1-2x};$$

$$y' = \sqrt{1-2x} - \frac{x}{\sqrt{1-2x}} = \frac{1-2x-x}{\sqrt{1-2x}} = \frac{1-3x}{\sqrt{1-2x}}; \quad x = \frac{1}{3};$$

$$y\left(\frac{1}{3}\right) = \frac{1}{3} \cdot \sqrt{1-\frac{2}{3}} = \frac{1}{3\sqrt{3}}; \quad y \in \left(-\infty; \frac{\sqrt{3}}{9} \right].$$

32.19.

$$y = x^3 - 3x^2 - 9x + \sqrt{16-x^4} + \left| \sqrt{16-x^4} - 5 \right|$$

$$a) 16 - x^4 \leq 16 \Rightarrow \sqrt{16-x^4} \leq 4 \Rightarrow 5 - \sqrt{16-x^4} \geq 1$$

$$\Rightarrow y = x^3 - 3x^2 - 9x + \sqrt{16-x^4} + 5 - \sqrt{16-x^4}$$

$$y = x^3 - 3x^2 - 9x + 5$$

$$b) 16 - x^4 \geq 0 \Rightarrow x^2 \leq 4 \Rightarrow |x| \leq 2$$

$$y' = 3x^2 - 6x - 9$$

$$x^2 - 2x - 3 = 0 \Rightarrow x = -1, x = 3$$

$$y(-2) = 3, \quad y(-1) = 10, \quad y(2) = -17$$

$$\Rightarrow y \in [-17; 10]$$

$$32.20. \begin{cases} a+b=24 \\ ab=\max \end{cases}; \begin{cases} a=24-b \\ 24b-b^2=y \end{cases};$$

$$y'=24-2b;$$

$$b=12, \quad y(12)=144;$$

$$b=12, \quad a=12.$$

$$32.21. ab=484; a=\frac{484}{b}; \frac{484}{b}+b=y; y'=1-\frac{484}{b^2};$$

$$b=22, \quad a=22.$$

$$32.22. a-b=98; a=98+b; b^2+98b=y; y'=2b+98;$$

$$b=-49, \quad a=49.$$

$$32.23. \begin{cases} a+b=3 \\ y=3a+b^3 \end{cases}; \begin{cases} a=3-b \\ y=3a+b^3 \end{cases};$$

$$y=9-3b+b^3; y'=3b^2-3;$$

$b=\pm 1$, но т.к. по условию $b > 0$, то

$$b=1, \quad a=2.$$

32.24.

$$\begin{cases} a+b=5 \\ y=ab^3 \end{cases}; \begin{cases} a=5-b \\ y=ab^3 \end{cases};$$

$$y=5b^3-b^4;$$

$$y'=15b^2-4b^3=b^2(15-4b);$$

$$b=0, \quad b=\frac{15}{4}, \text{ но т.к. по условию } b > 0, \text{ то } b=\frac{15}{4}, \quad a=\frac{5}{4}.$$

32.25.

$$\begin{cases} 2a+2b=56 \\ ab=y \end{cases}; \begin{cases} a=28-b \\ 28b-b^2=y \end{cases}; y'=28-2b; 2b=28;$$

$$b=14, \quad a=14.$$

32.26.

$$\begin{cases} a+b=100 \\ y=ab \end{cases}; \begin{cases} a=100-b \\ y=ab \end{cases}; y=100b-b^2; y'=100-2b;$$

$$b=50, \quad a=50.$$

32.27.

$$a) \begin{cases} ab=16 \\ 2a+2b=y \end{cases}; \begin{cases} a=\frac{16}{b} \\ 2a+2b=y \end{cases}; y=\frac{32}{b}+2b; y'=2-\frac{32}{b^2};$$

$$b=4, \quad a=4.$$

32.28.

$$\begin{cases} ab = 2500 \\ 2a + 2b = y \end{cases}; \begin{cases} a = \frac{2500}{b} \\ 2a + 2b = y \end{cases}; y = \frac{5000}{b} + 2b; y' = 2 - \frac{5000}{b^2};$$

$$b = 50, \quad a = 50.$$

32.29. $KD = DM = x; BH_1 = \frac{3\sqrt{2}}{2};$

$DH_2 = \frac{x\sqrt{2}}{2}$ (H_1 и H_2 – точки пересечения BD с PE и KM соответственно)

$$S = \frac{1}{2} (PE + KM) \cdot H_1 H_2 = \frac{1}{2} (x\sqrt{2} + 3\sqrt{2})(8\sqrt{2} - \frac{3\sqrt{2}}{2} - \frac{x\sqrt{2}}{2}) = \\ = \frac{1}{2} (39 + 10x - x^2);$$

$$S' = \frac{1}{2} (10 - 2x) = 0; x = 5; S = \frac{1}{2} (39 + 50 - 25) = 32.$$

32.30. $y = x^2, \quad A(0; 1,5);$

$$\sqrt{(0-x)^2 + (1,5-y)^2} = f(x);$$

$$f(x) = \sqrt{x^2 + (1,5 - x^2)^2} = \sqrt{x^2 + \frac{9}{4} - 3x^2 + x^4} = \sqrt{x^4 - 2x^2 + \frac{9}{4}}$$

$$f'(x) = \frac{4x^3 - 4x}{2\sqrt{x^4 - 2x^2 + \frac{9}{4}}} = 2 \cdot \frac{x^3 - x}{\sqrt{x^4 - 2x^2 + \frac{9}{4}}};$$

$$x = 0, \quad x = \pm 1;$$

$$f(0) = \frac{3}{2}; \quad f(1) = \sqrt{1 + \frac{1}{4}} = \frac{\sqrt{5}}{2} = f(-1); \quad (1; 1), (-1; 1)$$

32.31. $y = \sqrt{x}, \quad A(4,5; 0);$

$$f(x) = \sqrt{(4,5 - x)^2 + y^2} = \sqrt{\frac{81}{4} - 9x + x^2 + x} = \sqrt{\frac{81}{4} - 8x + x^2};$$

$$f'(x) = \frac{2x - 8}{2\sqrt{\frac{81}{4} - 8x + x^2}}; \quad x = 4; \quad y(4) = 2; \quad (4; 2).$$

32.32. $V = x^2 y = 32$ (y – высота бака, x – длина стороны его основания);

$$S = x^2 + 4xy = x^2 + \frac{128}{x}; \quad S'(x) = 2x - \frac{128}{x^2} = 0;$$

$$x^3 = 64; x_0 = 4; y_0 = 2.$$

Ответ: 4 дм; 4 дм; 2 дм.

32.33. $V = x^2 y = 343$ (y – высота бака, x – длина стороны его основания);

$$S = 2x^2 + 4xy = 2x^2 + \frac{1372}{x}; S' = 4x - \frac{1372}{x^2} = 0; x_0 = 7; y_0 = 7.$$

Ответ: 7 м; 7 м; 7 м.

32.34. $V = 6x^2 y = 576$ (y – высота короба, $2x$ и $3x$ – длины сторон его основания);

$$S = 12x^2 + 6xy + 4xy = 12x^2 + \frac{960}{x}; S'(x) = 24x - \frac{960}{x^2} = 0;$$

$$x^3 = 40; x_0 = 2\sqrt[3]{5}; y_0 = \frac{576}{6} \cdot \frac{1}{4\sqrt[3]{25}} = 24\frac{\sqrt[3]{5}}{5};$$

Ответ: $4\sqrt[3]{5}$ м; $6\sqrt[3]{5}$ м; $\frac{24\sqrt[3]{5}}{5}$ м.

32.35. $V = \sqrt{(d^2 - x^2)}x$ (x – длина бокового ребра призмы);

$$V' = d^2 - 3x^2 = 0; x = \frac{d}{\sqrt{3}} = \frac{\sqrt{3}}{3}d.$$

32.36. $S = \frac{1}{2}(15 + 2\sqrt{225 - h^2} + 15)h =$

$$= (15 + \sqrt{225 - h^2})h \text{ (здесь } h \text{ – высота трапеции);}$$

$$S' = 15 + \sqrt{225 - h^2} - \frac{h^2}{\sqrt{225 - h^2}}; 15 \cdot \sqrt{225 - h^2} + 225 - 2h^2 = 0;$$

$$50625 - 225h^2 = 50625 - 900h^2 + 4h^4;$$

$$4h^4 - 675h^2 = 0; h^2(4h^2 - 675) = 0;$$

$$h^2 = \frac{675}{4}; a = 15 + 2\sqrt{225 - \frac{675}{4}} = 15 + 2 \cdot \frac{15}{2} = 30.$$

32.37. а) Пусть α – угол между основанием и боковой стороной x – сторона прямоугольника, которая совпадает с высотой, y – его другая сторона.

$$\text{Тогда } \operatorname{tg} \alpha = 5 = \frac{x}{80 - y}; 80 - y = \frac{x}{5}; y = 80 - \frac{x}{5}; S(x) = 80x - \frac{x^2}{5};$$

$$S' = 80 - \frac{2x}{5};$$

$$x = 200, \text{ но } x \in (0; 100] \Rightarrow x = 100 \quad y = 60; S = 6000.$$

б) $a = 24$, $b = 8$, $h = 12$.

Пусть α - угол между большим основанием трапеции и ее боковой стороной, x - сторона прямоугольника, которая совпадает с высотой, y - его другая сторона.

$$\text{Тогда } \operatorname{tg} \alpha = \frac{3}{4} = \frac{x}{24-y}; \quad 24-y = \frac{4x}{3}; \quad y = 24 - \frac{4x}{3}; \quad S = 24x - \frac{4x^2}{3};$$

$$S' = 24 - \frac{8x}{3}; \quad x = 9, \quad y = 12; \quad S = 108.$$

32.38. а) Пусть x - сторона прямоугольника, лежащая на AB , y - его другая сторона, $\alpha = \angle DCB$.

$$\text{Тогда } \operatorname{tg} \alpha = \frac{7-5}{9-3} = \frac{2}{6} = \frac{1}{3} = \frac{x}{9-y}; \quad x = 3 - \frac{1}{3}y; \quad y = -3x + 9;$$

$$S = -3x^2 + 9x; \quad S' = -6x + 9; \quad x = \frac{3}{2}; \quad y = -\frac{9}{2} + 9 = \frac{9}{2}$$

но $AE \cdot AB = 21 \Rightarrow S_{\max} = 21$.

б) $a = 7$, $b = 18$, $c = 3$, $m = 1$;

Пусть x - сторона прямоугольника, лежащая на AB , y - его другая сторона, $\alpha = \angle DCB$.

$$AE \cdot AB \text{ Тогда } \operatorname{tg} \alpha = \frac{7-1}{18-3} = \frac{2}{5} = \frac{x}{18-y}; \quad 18-y = \frac{5}{2}x; \quad y = 18 - \frac{5}{2}x;$$

$$S = 18x - \frac{5}{2}x^2; \quad S' = 18 - 5x; \quad x = \frac{18}{5}; \quad y = 9; \quad S = 32,4;$$

$$AE \cdot AB = 21 \Rightarrow S_{\max} = 32,4.$$

32.39.

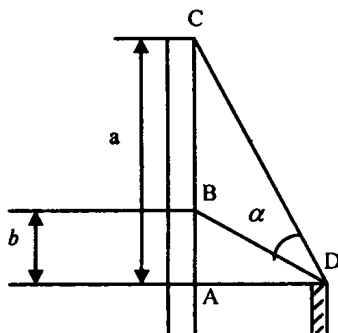

$$AC = a; \quad AB = b;$$

$$CB = AC - AB = a - b; \quad AD = x;$$

$$BD = \sqrt{x^2 + b^2}; \quad CD = \sqrt{x^2 + a^2}.$$

По теореме косинусов

$$(a-b)^2 = x^2 + b^2 + x^2 + a^2 - 2\sqrt{(x^2 + b^2)(x^2 + a^2)} \cos \alpha ;$$

$$2x^2 + 2ab = 2\sqrt{(x^2 + b^2)(x^2 + a^2)} \cos \alpha ;$$

$$\cos \alpha = \frac{x^2 + ab}{\sqrt{(x^2 + b^2)(x^2 + a^2)}} .$$

$$f(x) = \frac{x^2 + ab}{\sqrt{(x^2 + b^2)(x^2 + a^2)}} = \frac{x^2 + ab}{\sqrt{x^4 + x^2(a^2 + b^2) + b^2 a^2}} ;$$

$$f'(x) = \frac{2x\sqrt{x^4 + x^2(a^2 + b^2) + b^2 a^2} - (x^2 + ab)(4x^3 + 2x(a^2 + b^2))}{(x^2 + b^2)(x^2 + a^2)} = 0 ;$$

$$2x\sqrt{(x^2 + b^2)(x^2 + a^2)} = x(x^2 + ab) \frac{2x^2 + a^2 + b^2}{\sqrt{(x^2 + b^2)(x^2 + a^2)}} ;$$

$$2(a^2 b^2 + x^2 a^2 + x^2 b^2 + x^4) = 2x^4 + 2x^2 ab + x^2 a^2 + x^2 b^2 + a^3 b + ab^3 ;$$

$$2ab(ab - x^2) + a^2(x^2 - ab) + b^2(x^2 - ab) = 0 ;$$

$$(x^2 - ab)(a - b)^2 = 0 ; \quad x = \sqrt{ab} ;$$

$$\alpha_{\max} \text{ при } x = \sqrt{ab} .$$

32.40.

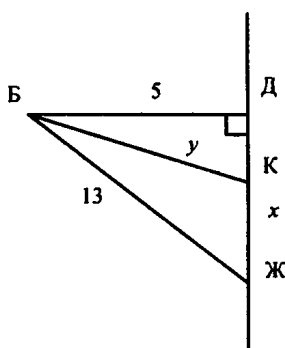

$$ЖД = 12 ;$$

x – расстояние, которое пешеход пройдет по дороге;

y – расстояние, которое пешеход пройдет по лесу;

$$\text{Суммарное время: } t = \frac{x}{5} + \frac{y}{3};$$

$$DK = 12 - x; \quad y = \sqrt{25 + (12 - x)^2};$$

$$t' = \frac{1}{5} + \frac{2x - 24}{2 \cdot 3 \sqrt{x^2 - 24x + 169}} = \frac{1}{5} + \frac{x - 12}{3 \sqrt{x^2 - 24x + 169}} = 0;$$

$$\frac{3}{5} \sqrt{x^2 - 24x + 169} = 12 - x;$$

$$9x^2 - 9 \cdot 24x + 9 \cdot 169 = 25(144 - 24x + x^2);$$

$$16x^2 - 384x + 2079 = 0;$$

$$x_1 = 8,25; \quad x_2 = 15,75 - \text{не подходит};$$

$$x = \frac{33}{4}; \quad y = \sqrt{25 + 3,75^2} = \frac{25}{4};$$

$$t = \frac{x}{5} + \frac{4}{5} = \frac{33}{20} + \frac{25}{12} = \frac{56}{15} \approx 3 \text{ часа } 44 \text{ минуты.}$$

Глава 6. Степени и корни.

Степенные функции

§ 33. Понятие корня n -й степени действительного числа

- 33.1. а) 3; 4 б) 5; 7 в) 11; 2 г) 37; 15
- 33.2. а) $\sqrt{361} = 19$; $19^2 = 361$. б) $\sqrt[6]{\frac{1}{64}} = \frac{1}{2}$; $\left(\frac{1}{2}\right)^6 = \frac{1}{64}$.
- в) $\sqrt[3]{343} = 7$; $7^3 = 343$. г) $\sqrt[5]{\frac{32}{243}} = \frac{2}{3}$; $\left(\frac{2}{3}\right)^5 = \frac{32}{243}$
- 33.3. а) $\sqrt{25} = -5$; $\sqrt{25} = 5$. б) $\sqrt[6]{-64} = -2$; $(-2)^6 \neq -64$.
- в) $-\sqrt[3]{-8} = -2$; $\sqrt[3]{-8} = 2$; $-8 \neq 2^3$. г) $\sqrt[4]{625} = -25$; $(-25)^4 = 625^2$.
- 33.4. а) $\sqrt{7-4\sqrt{3}} = 2-\sqrt{3}$; $7-4\sqrt{3} = 4+3-4\sqrt{3}$. Верно.
- б) $\sqrt{9-4\sqrt{5}} = 2-\sqrt{5}$; $2-\sqrt{5} < 0 \Rightarrow$ Неверно.
- в) $\sqrt{7-4\sqrt{3}} = \sqrt{3}-2$; $\sqrt{3}-2 < 0 \Rightarrow$ Неверно.
- г) $\sqrt{9-4\sqrt{5}} = \sqrt{5}-2$; $9-4\sqrt{5} = 5+4-4\sqrt{5} \Rightarrow$ Верно.
- 33.5. а) $\sqrt[4]{16} = 2$; б) $\sqrt[3]{32} = 2$; в) $\sqrt[4]{81} = 3$; г) $\sqrt[3]{64} = 4$.
- 33.6. а) $\sqrt[3]{0,125} = 0,5$; б) $\sqrt[4]{0,0625} = 0,5$; в) $\sqrt[4]{0,0081} = 0,3$; г) $\sqrt[3]{0,027} = 0,3$.
- 33.7. а) $\sqrt[4]{\frac{16}{625}} = \frac{2}{5}$ б) $\sqrt[3]{3\frac{3}{8}} = \sqrt[3]{\frac{27}{8}} = \frac{3}{2}$
- в) $\sqrt{\frac{100}{121}} = \frac{10}{11}$ г) $\sqrt[5]{7\frac{19}{32}} = \sqrt[5]{\frac{243}{32}} = \frac{3}{2}$
- 33.8. а) $\sqrt{-128} = -2$; б) $\sqrt[3]{-\frac{1}{8}} = -\frac{1}{2}$;
- в) $\sqrt[3]{-64} = -4$; г) $\sqrt[5]{-\frac{1}{32}} = -\frac{1}{2}$.
- 33.9. а) $\sqrt[3]{32} + \sqrt[3]{-8} = 2 - 2 = 0$; б) $\sqrt[4]{625} - \sqrt[3]{-125} = 5 + 5 = 10$;
- в) $3\sqrt[4]{16} - 4\sqrt[3]{27} = 6 - 12 = -6$; г) $12 - 6\sqrt[3]{0,125} = 12 - 3 = 9$.
- 33.10. а) $2^2 < 5 < 3^2 \Rightarrow \sqrt{5} \in [2, 3]$; б) $2^3 < 19 < 3^3 \Rightarrow \sqrt[3]{19} \in [2, 3]$;
- в) $2^4 < 52 < 3^4 \Rightarrow \sqrt[4]{52} \in [2, 3]$; г) $3^3 < 63 < 4^3 \Rightarrow \sqrt[3]{63} \in [3, 4]$.

$$33.11. \text{ а) } x^3 = 125; x = \sqrt[3]{125}; x = 5; \quad \text{б) } x^7 = \frac{1}{128}; x = \frac{1}{2};$$

$$\text{в) } x^5 = 32; x = 2.$$

$$\text{г) } x^9 = 1; x = 1.$$

$$33.12. \text{ а) } x^4 = 17; x = \pm\sqrt[4]{17}.$$

$$\text{б) } x^4 = -16 \text{ — решений нет.}$$

$$\text{в) } x^6 = 11; x = \pm\sqrt[6]{11}.$$

$$\text{г) } x^8 = -3 \text{ — решений нет.}$$

$$33.13. \text{ а) } 0,02x^6 - 1,28 = 0; x^6 = 64; x = \pm 2.$$

$$\text{б) } -\frac{3}{4}x^8 + 18\frac{3}{4} = 0; x^8 = 25; x = \pm\sqrt[4]{5}.$$

$$\text{в) } 0,3x^9 - 2,4 = 0; x^9 = 8; x = \sqrt[3]{2}.$$

$$\text{г) } \frac{1}{8}x^4 - 2 = 0; x^4 = 16; x = \pm 2.$$

$$33.14. \text{ а) } \sqrt[3]{x-5} = -3; x-5 = -27; x = -22.$$

$$\text{б) } \sqrt[4]{4-5x} = -2 \text{ — решений нет.}$$

$$\text{в) } \sqrt[2]{2x+8} = -1; 2x+8 = -1; x = -\frac{9}{2}.$$

$$\text{г) } \sqrt[3]{7-4x} = 4; 7-4x = 64; x = -\frac{57}{4}.$$

$$33.15. \text{ а) } \sqrt[3]{x^2-9x-19} = -3; x^2-9x-19 = -27; x^2-9x+8 = 0; x = 1, x = 8.$$

$$\text{б) } \sqrt[4]{x^2-10x+25} = 2; x^2-10x+25 = 16; x^2-10x+9 = 0; x = 9, x = 1.$$

$$\text{в) } \sqrt[2]{2x^2+6x-57} = -1; 2x^2+6x-56 = 0; x^2+3x-28 = 0;$$

$$x = \frac{-3+11}{2} = 4; x = \frac{-3-11}{2} = -7.$$

$$\text{г) } \sqrt[6]{x^2+7x+13} = 1; x^2+7x+12 = 0; x = -4, x = -3.$$

$$33.16. \text{ а) } \sqrt[3]{5}; 2; \sqrt[4]{17}.$$

$$\text{б) } \sqrt[3]{100}; 4; \sqrt[3]{75}.$$

$$\text{в) } \sqrt[3]{7}; \sqrt[2]{40}; 3.$$

$$\text{г) } \sqrt[6]{60}; 2; \sqrt[4]{20}.$$

$$33.17. \text{ а) } \sqrt[4]{0,1}; -1; \sqrt[3]{-5}.$$

$$\text{б) } 0; \sqrt[3]{-0,25}; \sqrt[2]{-29}.$$

$$\text{в) } \sqrt[2]{-1,5}; -2; \sqrt[3]{-9}.$$

$$\text{г) } \sqrt[3]{2}; 1; \sqrt[2]{-2}.$$

$$33.18. \text{ а) } \sqrt[3]{15} - \sqrt[4]{90} < 0; \sqrt[3]{15} < \sqrt[3]{27} = 3, \sqrt[4]{90} > \sqrt[4]{64} = 4 \Rightarrow \sqrt[3]{15} - \sqrt[3]{90} < 0$$

Пункты б), в), г) решаются аналогично.

$$\text{б) } 3 - \sqrt[2]{150} > 0.$$

$$\text{в) } \sqrt[2]{40} - \sqrt[3]{50} < 0.$$

$$\text{г) } \sqrt[3]{300} - 5 < 0.$$

$$33.19. \text{ а) } \sqrt[2]{-12}; \frac{\pi}{2}; 2; \sqrt[6]{70}.$$

$$\text{б) } \sqrt[2]{-\pi}; \frac{3}{\pi}; 1; \sqrt[2]{\pi}.$$

$$\text{в) } \sqrt[2]{-2}; \frac{\pi}{3}; 2,5; \sqrt{2\pi}.$$

$$\text{г) } \sqrt[2]{-\frac{1}{2}}; 0; \sqrt[3]{200}; 2\pi.$$

§ 34. Функции $y = \sqrt[n]{x}$, их свойства и графики

34.1.

а)

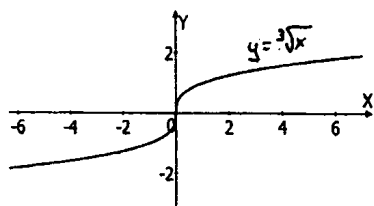

б)

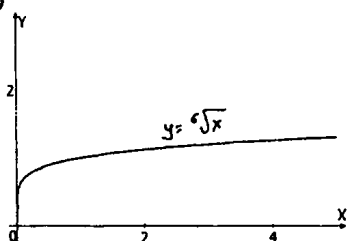

в)

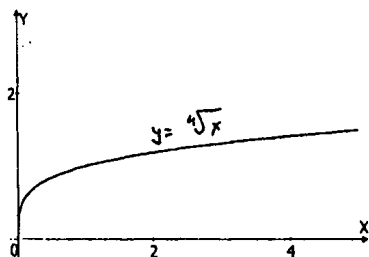

г)

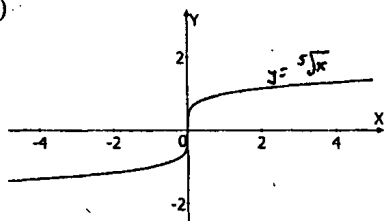

34.2. а)

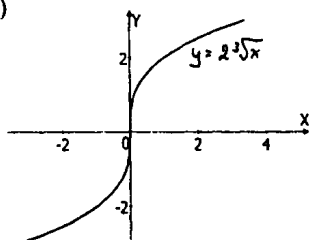

б)

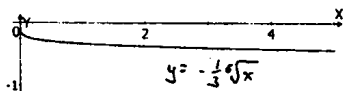

в)

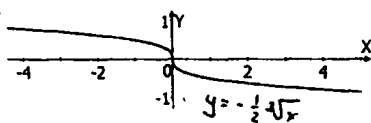

г)

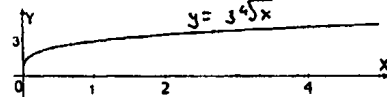

34.3. а)

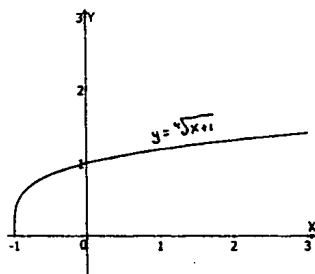

б)

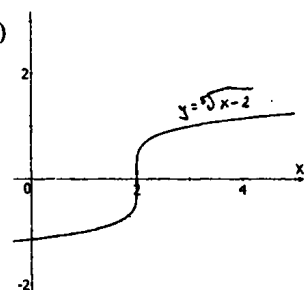

B)

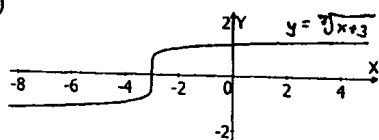

Г)

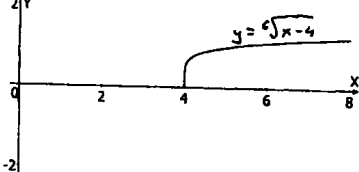

34.4. a)

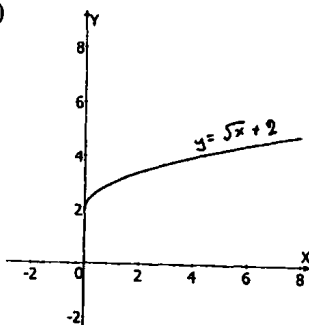

б)

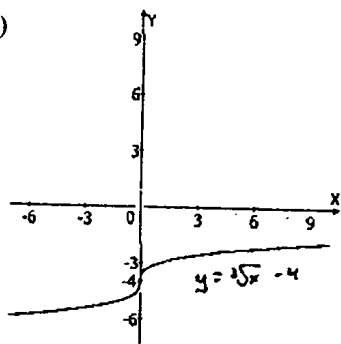

B)

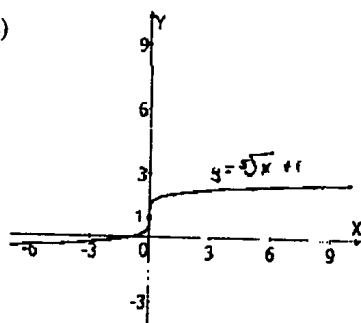

Г)

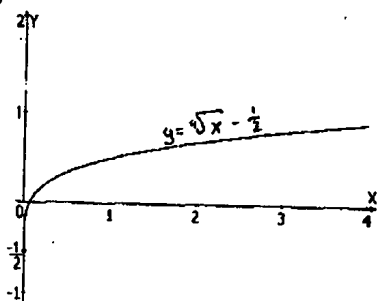

34.5.

a)

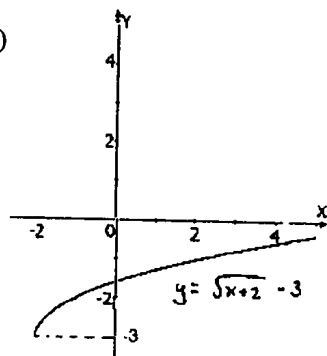

б)

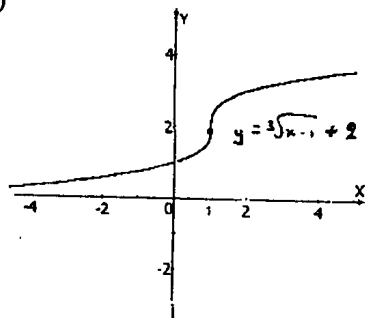

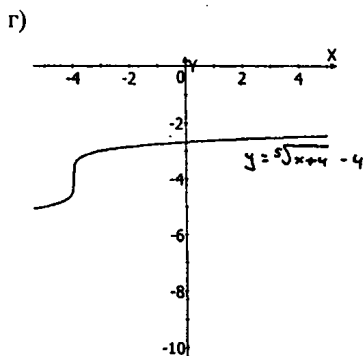
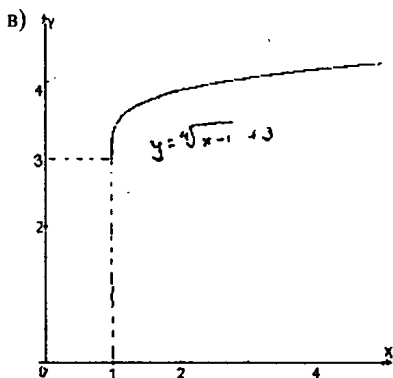

34.6. $y = \sqrt[4]{x}$; а) $x \in [0; 1]$, $\min y = 0$, $\max y = 1$;

б) $x \in [1; 3]$, $\min y = 1$, $\max y$ не существует;

в) $x \in [5; 16]$, $\min y = \sqrt[4]{5}$, $\max y = 2$;

г) $x \in [16; +\infty)$, $\min y = 2$, $\max y$ не существует;

34.7. $y = \sqrt[5]{x}$; а) $x \in [-1; 1]$, $\min y = -1$, $\max y = 1$;

б) $x \in (-\infty; 1]$, $\min y$ не существует, $\max y = 1$;

в) $x \in [-32; 32]$, $\min y = -2$, $\max y = 2$;

г) $x \in [2; +\infty)$, $\min y = \sqrt[5]{2}$, $\max y$ не существует.

34.8. а) $y = \sqrt[4]{x}$; $y = x^2$; $\sqrt[4]{x} = x^2$; $x = x^8$; $x = 1$, $x = 0$; $(0; 0)$, $(1; 1)$.

б) $y = \sqrt[3]{x}$; $y = |x|$; $\sqrt[3]{x} = |x|$; $x = 1$, $x = 0$; $(0; 0)$, $(1; 1)$.

в) $y = \sqrt[6]{x}$; $y = x$; $\sqrt[6]{x} = x$; $x = 1$, $x = 0$; $(0; 0)$; $(1; 1)$.

г) $y = \sqrt[5]{x}$; $y = -x - 2$; $\sqrt[5]{x} = -x - 2$; $x = 1$; $(-1; -1)$.

34.9. а) $x = 0$ б) $x = 1$

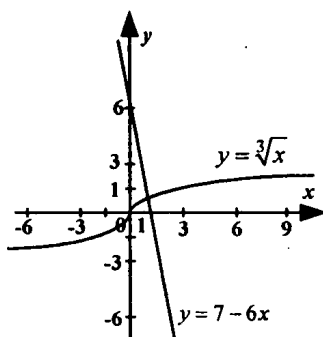
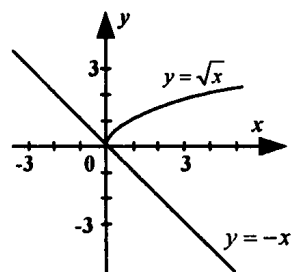

в) $x = 1$

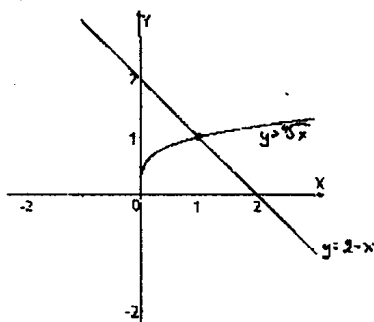

г) $x = 0, x = -1$

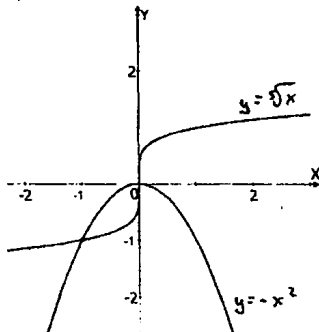

34.10. а) $\begin{cases} y = \sqrt[4]{x} \\ 2x - 3y = 6 \end{cases}; \begin{cases} y = \sqrt[4]{x} \\ y = \frac{2x}{3} - 2 \end{cases}$ — одно решение.

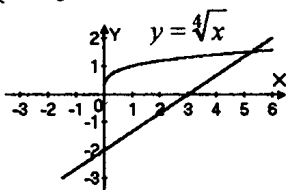

б) $\begin{cases} y = \sqrt[3]{x} \\ 3y - 4x = 0 \end{cases}; \begin{cases} y = \frac{4}{3}x \\ y = \sqrt[3]{x} \end{cases}$ — три решения (в ответе задачника опечатка).

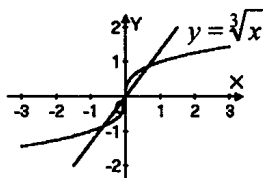

в) $\begin{cases} y = \sqrt[5]{x} \\ 6 - 2x - 3y = 0 \end{cases}; \begin{cases} y = \sqrt[5]{x} \\ y = 2 - \frac{2}{3}x \end{cases}$ — одно решение.

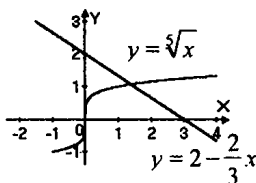

$$\text{г) } \begin{cases} y = \sqrt[6]{x} \\ 5 + x - 2y = 0 \end{cases}; \begin{cases} y = \sqrt[6]{x} \\ y = \frac{5}{2} + \frac{x}{2} \end{cases} \text{ — нет решений.}$$

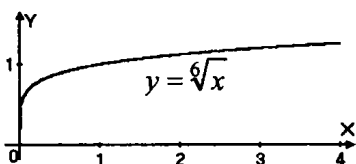

$$34.11. y = \begin{cases} 2x^2, & x < 0 \\ \sqrt[4]{x}, & x \geq 0 \end{cases}$$

- 1) $y(x)$ убывает при $x \leq 0$, возрастает при $x \geq 0$.
- 2) $x_{\min} = 0, y_{\min} \leq 0$.
- 3) $y = 0$ при $x = 0$.

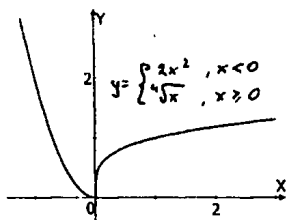

$$34.12. y = \begin{cases} \frac{3}{x}, & x < 0 \\ \sqrt[3]{x}, & x \geq 0 \end{cases}$$

- 1) $y(x)$ убывает при $x < 0$, возрастает при $x \geq 0$.
- 2) Экстремумов нет.
- 3) $y = 0$ при $x = 0$.

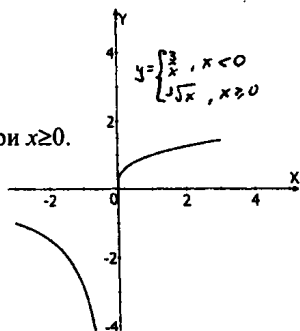

$$34.13. y = \begin{cases} \sqrt[5]{x}, & x < 0 \\ \sqrt{x}, & x \geq 0 \end{cases}$$

- 1) $y(x)$ убывает на всей числовой прямой.
- 2) Экстремумов нет.
- 3) $y = 0$ при $x = 0$.

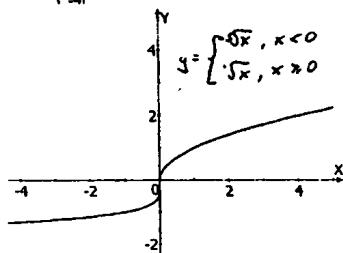

$$34.14. \text{ а) } y = \sqrt[4]{2x-4}; 2x-4 \geq 0; x \geq 2;$$

$$\text{ б) } y = \sqrt[6]{3x-9}; 3x-9 \geq 0; x \geq 3.$$

$$\text{ в) } y = \sqrt[8]{2-3x}; 2-3x \geq 0; x \leq \frac{2}{3}.$$

$$\text{ г) } y = \sqrt[12]{1-5x}; 1-5x \geq 0; x \leq \frac{1}{5}.$$

$$34.15. \text{ а) } y = \sqrt[3]{x^2 + 5}; x \in R. \quad \text{б) } y = \sqrt[7]{x^3 - 1}; x \in R.$$

$$\text{в) } y = \sqrt[9]{6x - 7}; x \in R. \quad \text{г) } y = \sqrt[5]{2x + 1}; x \in R.$$

$$34.16. \text{ а) } y = \sqrt{5x + 8} + \sqrt[4]{2x - 4};$$

$$\begin{cases} x \geq 2 \\ x \geq -\frac{8}{5} \Rightarrow x \geq 2; x \in [2, +\infty). \end{cases}$$

$$\text{б) } y = \sqrt[6]{2x + 1} - \sqrt[8]{5 - 10x}; \begin{cases} 2x + 1 \geq 0 \\ 5 - 10x \geq 0 \end{cases};$$

$$\begin{cases} x \geq -\frac{1}{2} \\ x \leq \frac{1}{2} \end{cases} \Rightarrow x \in \left[-\frac{1}{2}; \frac{1}{2}\right].$$

$$\text{в) } y = \sqrt[10]{3x - 12} - \sqrt[4]{2x - 1}; \begin{cases} 3x - 12 \geq 0 \\ 2x - 1 \geq 0 \end{cases};$$

$$\begin{cases} x \geq 4 \\ x \geq \frac{1}{2} \Rightarrow x \geq 4; x \in [4, +\infty). \end{cases}$$

$$\text{г) } y = \sqrt{8 - 16x} + \sqrt[12]{10x + 20}; \begin{cases} 8 - 16x \geq 0 \\ 10x + 20 \geq 0 \end{cases};$$

$$\begin{cases} x \leq \frac{1}{2} \\ x \geq -2 \end{cases} \Rightarrow x \in \left[-2, \frac{1}{2}\right].$$

$$34.17. \text{ а) } y = \sqrt{x^2 + 4x - 12}; x^2 + 4x - 12 \geq 0; \text{ корни: } x_1 = -6; x_2 = 2; \\ x \in (-\infty; -6] \cup [2; +\infty),$$

$$\text{б) } y = \sqrt[12]{15 - x^2 + 2x}; -x^2 + 2x + 15 \geq 0; x^2 - 2x - 15 \leq 0; \\ \text{корни: } x_1 = -3; x_2 = 5; x \in [-3; 5].$$

$$\text{в) } y = \sqrt{x^2 - 8x + 12}; x^2 - 8x + 12 \geq 0; \text{ корни: } x_1 = 2; x_2 = 6; \\ x \leq 2, x \geq 6; x \in (-\infty, 2] \cup [6, +\infty).$$

$$\text{г) } y = \sqrt[6]{4 - x^2 - 3x}; 4 - x^2 - 3x \geq 0; x^2 + 3x - 4 \leq 0; x \in [-4; 1].$$

$$34.18. \text{ а) } y = \sqrt[4]{\frac{x - 8}{3x + 5}}; \frac{x - 8}{3x + 5} \geq 0; x \geq 8, x < -\frac{5}{3}, x \in \left(-\infty; -\frac{5}{3}\right) \cup (8; +\infty).$$

$$\text{б) } y = \sqrt[5]{\frac{1 + 9x}{4 + 3x}}; x \in R \text{ кроме } x = -\frac{4}{3}.$$

$$в) y = \sqrt[3]{\frac{12-5x}{7-2x}}; x \in R \text{ кроме } x = \frac{7}{2}.$$

$$г) y = \sqrt{\frac{3-7x}{2x+9}}; \frac{3-7x}{2x+9} \geq 0; \frac{7x-3}{2x+9} \leq 0; x \in \left(-4, 5; \frac{3}{7}\right].$$

$$34.19. а) y = \sqrt[4]{x+1}; y \in [0; +\infty). \quad б) y = \sqrt[5]{x-2}; y \in R.$$

$$в) y = \sqrt[7]{x+3}; y \in R. \quad г) y = \sqrt[6]{x-4}; y \in [0; +\infty).$$

$$34.20. а) y = 2 + \sqrt[4]{x}; y \in [2; +\infty). \quad б) y = \sqrt[5]{x} - 3; y \in R.$$

$$в) y = \sqrt[6]{x} - 3; y \in [-3; +\infty). \quad г) y = 2 + \sqrt[3]{x}; y \in R$$

$$34.21. а) y = \sqrt[4]{x^2 - 6x + 8}$$

Y принимает минимальное значение, когда $x^2 - 6x + 8$ минимальное неотрицательное.

$$x_0 = \frac{-6}{2} = -3; \Rightarrow \min(x^2 + 6x + 13) = x_0^2 + 6x_0 + 13 = 4 \Rightarrow y_{\min} = \sqrt[3]{2}.$$

$$б) y = \sqrt[6]{x^2 + 6x + 10}$$

$$y' = \frac{2x+6}{\frac{5}{6}(x^2+6x+10)^{5/6}} \Rightarrow x = -3 \Rightarrow y_{\min} = y(-3) = 1$$

34.22. а)

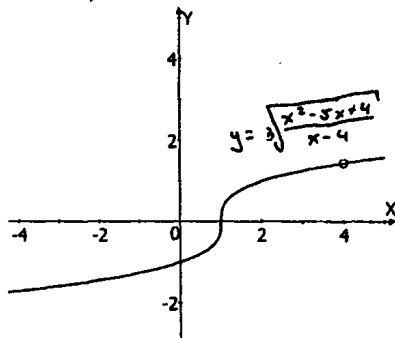

б)

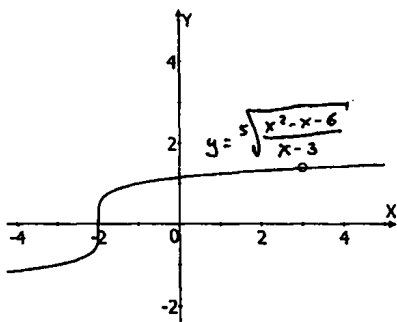

$$б) y = \sqrt[4]{\frac{x^2 - x - 6}{x - 3}} = \sqrt[4]{x + 2}, x \neq 3$$

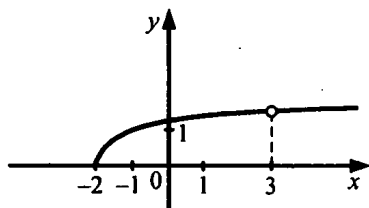

§ 35. Свойства корня n -й степени

$$35.1. \text{ а) } \sqrt[3]{8 \cdot 27} = 2 \cdot 3 = 6;$$

$$\text{б) } \sqrt[4]{16 \cdot 0,0001} = 2 \cdot 0,1 = 0,2;$$

$$\text{в) } \sqrt[4]{625 \cdot 16} = 5 \cdot 2 = 10;$$

$$\text{г) } \sqrt[5]{0,00032 \cdot 243} = 0,2 \cdot 3 = \frac{3}{5}.$$

$$35.2. \text{ а) } \sqrt[5]{243 \cdot \frac{1}{32}} = 3 \cdot \frac{1}{2} = \frac{3}{2};$$

$$\text{б) } \sqrt[3]{\frac{8}{125}} = \frac{2}{5};$$

$$\text{в) } \sqrt[5]{7 \cdot \frac{19}{32}} = \sqrt[5]{\frac{243}{32}} = \frac{3}{2};$$

$$\text{г) } \sqrt[6]{64 \cdot \frac{1}{729}} = 2 \cdot \frac{1}{3} = \frac{2}{3}.$$

$$35.3. \text{ а) } \sqrt[3]{24 \cdot 9} = \sqrt[3]{8 \cdot 27} = 2 \cdot 3 = 6;$$

$$\text{б) } \sqrt[5]{48 \cdot 162} = \sqrt[5]{16 \cdot 3 \cdot 2 \cdot 81} = \sqrt[5]{2^5 \cdot 3^5} = 2 \cdot 3 = 6;$$

$$\text{в) } \sqrt[3]{75 \cdot 45} = 3 \sqrt[3]{75 \cdot \frac{5}{3}} = 3 \cdot 5 = 15;$$

$$\text{г) } \sqrt[4]{54 \cdot 24} = \sqrt[4]{9 \cdot 6 \cdot 3 \cdot 8} = 3 \cdot 2 = 6.$$

$$35.4. \text{ а) } \sqrt[4]{\frac{125}{0,2}} = \sqrt[4]{625} = 5;$$

$$\text{б) } \sqrt[4]{\frac{16}{0,0625}} = \frac{2}{0,5} = 4;$$

$$\text{в) } \sqrt[3]{\frac{27}{0,125}} = \frac{3}{0,5} = 6;$$

$$\text{г) } \sqrt[6]{\frac{16}{0,25}} = \sqrt[6]{64} = 2.$$

$$35.5. \text{ а) } \sqrt[3]{5^6 \cdot 2^9} = 5^2 \cdot 2^3 = 25 \cdot 8 = 200; \text{ в) } \sqrt[3]{0,2^3 \cdot 5^6} = 0,2 \cdot 5^2 = 5;$$

$$\text{б) } \sqrt[5]{0,2^{10} \cdot 10^{10}} = 0,2^2 \cdot 10^2 = 2^2 = 4; \text{ г) } \sqrt[6]{36^3 \cdot 2^6} = 6 \cdot 2 = 12.$$

$$35.6. \text{ а) } \sqrt[4]{\frac{7^8}{3^4}} = \frac{7^2}{3} = \frac{49}{3};$$

$$\text{б) } \sqrt[3]{\frac{5^6}{3^9}} = \frac{5^2}{3^3} = \frac{25}{27};$$

$$\text{в) } \sqrt[4]{\frac{3^{12}}{2^8}} = \frac{3^3}{2^2} = \frac{27}{4};$$

$$\text{г) } \sqrt[5]{\frac{5^5}{13^{10}}} = \frac{5}{169}.$$

$$35.7. \text{ а) } \sqrt[4]{x^2} = \sqrt{x};$$

$$\text{б) } \sqrt[6]{y^4} = \sqrt[3]{y^2};$$

$$\text{в) } \sqrt[10]{a^5} = \sqrt{a};$$

$$\text{г) } \sqrt[24]{n^{16}} = \sqrt[3]{n^2}.$$

$$35.8. \text{ а) } \sqrt[4]{b^8} = b^2; \text{ б) } \sqrt{l^6} = l^3;$$

$$\text{в) } \sqrt[5]{d^{15}} = d^3; \text{ г) } \sqrt[3]{t^{12}} = t^4.$$

$$35.9. \text{ а) } \sqrt{a^2 b^4} = ab^2;$$

$$\text{б) } \sqrt[3]{a^3 b^6} = ab^2;$$

$$\text{в) } \sqrt[4]{a^4 b^8} = ab^2;$$

$$\text{г) } \sqrt[5]{a^5 b^{15}} = ab^3.$$

$$35.10. \text{ а) } \sqrt{\frac{49a^4}{169b^2}} = \frac{7a^2}{13b} = \frac{7}{13} \frac{a^2}{b};$$

$$\text{б) } \sqrt[4]{\frac{16a^4 b^8}{c^{12}}} = \frac{2ab^2}{c^3};$$

$$b) \sqrt[3]{\frac{27a^6}{64b^3}} = \frac{3a^2}{4b};$$

$$35.11. a) \sqrt[4]{4} \cdot \sqrt[4]{4} = \sqrt[4]{16} = 2;$$

$$b) \sqrt{20} \cdot \sqrt{5} = \sqrt{100} = 10;$$

$$35.12. a) \frac{\sqrt[3]{54}}{\sqrt[3]{2}} = \sqrt[3]{\frac{54}{2}} = \sqrt[3]{27} = 3;$$

$$b) \frac{\sqrt[7]{256}}{\sqrt[7]{2}} = \sqrt[7]{\frac{256}{2}} = \sqrt[7]{128} = 2;$$

$$r) \sqrt[5]{\frac{32a^{40}b^{10}}{243c^{15}}} = \frac{2 \cdot a^8 b^2}{3c^3}.$$

$$b) \sqrt[3]{135} \cdot \sqrt[3]{25} = \sqrt[3]{27 \cdot 5 \cdot 25} = 15;$$

$$r) \sqrt[5]{16} \cdot \sqrt[5]{486} = \sqrt[5]{16 \cdot 2 \cdot 243} = 6.$$

$$b) \frac{\sqrt[5]{3}}{\sqrt[5]{96}} = \sqrt[5]{\frac{3}{32}} = \frac{1}{2};$$

$$r) \frac{\sqrt[4]{256}}{\sqrt[4]{4}} = \sqrt[4]{\frac{256}{4}} = \sqrt[4]{64} = 2\sqrt{2}.$$

$$35.13. a) \sqrt[4]{32 \cdot 3} \cdot \sqrt[4]{8 \cdot 27} = \sqrt[4]{256 \cdot 81} = 4 \cdot 3 = 12;$$

$$b) \sqrt[5]{2^5 \cdot 7^2} \cdot \sqrt[5]{7^3} = 2 \cdot 7 = 14.$$

$$35.14. a) \sqrt[3]{2} \text{ и } \sqrt[6]{3}, \sqrt[6]{4} \text{ и } \sqrt[6]{3}; \quad b) \sqrt[4]{5} \text{ и } \sqrt[3]{9}, \sqrt[12]{125} \text{ и } \sqrt[12]{6561};$$

$$b) \sqrt{7} \text{ и } \sqrt[12]{8}, \sqrt[4]{49} \text{ и } \sqrt[4]{2}; \quad r) \sqrt[3]{3} \text{ и } \sqrt[2]{2}, \sqrt[15]{243} \text{ и } \sqrt[15]{8}.$$

$$35.15. a) \sqrt{3}, \sqrt[3]{4} \text{ и } \sqrt[6]{7}, \quad \sqrt[6]{27}, \sqrt[6]{16} \text{ и } \sqrt[6]{7};$$

$$b) \sqrt{2}, \sqrt[3]{3} \text{ и } \sqrt[4]{4}, \quad \sqrt[6]{8}, \sqrt[6]{9} \text{ и } \sqrt[6]{8};$$

$$b) \sqrt{6}, \sqrt[4]{17} \text{ и } \sqrt[8]{40}, \quad \sqrt[8]{1296}, \sqrt[8]{289} \text{ и } \sqrt[8]{40};$$

$$r) \sqrt[5]{3}, \sqrt[3]{2} \text{ и } \sqrt[15]{100}, \quad \sqrt[15]{27}, \sqrt[15]{32} \text{ и } \sqrt[15]{100}.$$

$$35.16/ a) \sqrt[4]{26} \vee \sqrt{5}, \sqrt[4]{26} > \sqrt[4]{25};$$

$$b) \sqrt[3]{5} \vee \sqrt{3}, \quad \sqrt[6]{25} < \sqrt[6]{27};$$

$$b) \sqrt[3]{7} \vee \sqrt[6]{47}, \quad \sqrt[6]{49} > \sqrt[6]{47};$$

$$r) -\sqrt[4]{4} \vee -\sqrt[3]{3}, \quad -\sqrt[6]{8} > -\sqrt[6]{9}.$$

$$35.17. a) \sqrt{2} \sqrt[4]{2} = \sqrt[4]{4^4 \cdot 2} = \sqrt[4]{8}; \quad b) \sqrt[3]{3} \sqrt[6]{3} = \sqrt[6]{9^6 \cdot 3} = \sqrt[6]{27};$$

$$b) \sqrt{2} \sqrt[3]{3} = \sqrt[6]{8 \cdot 9} = \sqrt[6]{72}; \quad r) \sqrt[4]{2} \sqrt[6]{3} = \sqrt[12]{8 \cdot 9} = \sqrt[12]{72}.$$

$$35.18. a) \sqrt[4]{3b^3} \sqrt{3b} = \sqrt[4]{3b^3} \sqrt[4]{9b^2} = \sqrt[4]{27b^5};$$

$$b) \sqrt{2a} \sqrt[6]{4a^5} = \sqrt[6]{8a^3} \sqrt[6]{4a^5} = \sqrt[6]{32a^8};$$

$$b) \sqrt{a} \sqrt[6]{a^5} = \sqrt[6]{a^3} \sqrt[6]{a^5} = \sqrt[6]{a^8}; \quad r) \sqrt[3]{y} \sqrt[6]{3y^3} = \sqrt[6]{y^2} \sqrt[6]{y^3} = \sqrt[6]{3y^5}.$$

$$35.19. a) \sqrt[3]{ab} \sqrt[6]{4ab} = \sqrt[6]{a^2 b^2} \sqrt[6]{4a^3 b^3} = \sqrt[6]{4a^3 b^3};$$

$$b) \sqrt[5]{a^4 b^3} \cdot \sqrt[10]{a^5 b^2} = \sqrt[10]{a^8 b^6} \sqrt[10]{a^5 b^2} = \sqrt[10]{a^{13} b^8};$$

$$b) \sqrt[6]{5ab^2} \cdot \sqrt[3]{5a^3 b^4} = \sqrt[6]{5ab^2} \sqrt[6]{25a^6 b^8} = \sqrt[6]{125a^7 b^{10}};$$

$$r) \sqrt[8]{6xz} \cdot \sqrt[4]{xz^5} = \sqrt[24]{216x^3 z^3} \sqrt[24]{x^4 z^{20}} = \sqrt[24]{216x^7 z^{23}}.$$

$$35.20. a) \sqrt[4]{a^3} : \sqrt{a} = \sqrt[4]{a}; \quad b) \sqrt[12]{a^2 b^3} : \sqrt[6]{ab^4} = \sqrt[12]{b^{-5}};$$

$$b) \sqrt[6]{a^5} : \sqrt[4]{a} = \sqrt[12]{a^7}; \quad r) \sqrt[4]{a^3 b^5} : \sqrt[5]{ab} = \sqrt[20]{a^{11} b^{21}}.$$

$$35.21. \text{ а) } (\sqrt{3})^2 = 3; \text{ б) } (\sqrt[n]{a})^n = a; \text{ в) } (\sqrt[5]{7})^5 = 7; \text{ г) } (\sqrt[p]{b})^p = b.$$

$$35.22. \text{ а) } (2\sqrt{5})^4 = 16 \cdot 25 = 400; \quad \text{ б) } \left(b \sqrt[n]{\frac{1}{b}}\right)^{2n} = b^{2n} \cdot \frac{1}{b^2} = b^{2n-2};$$

$$\text{ в) } \left(3 \cdot \sqrt[n]{\frac{1}{2}}\right)^{2n} = \frac{243}{2}; \quad \text{ г) } \left(\frac{1}{b} \sqrt[p]{b}\right)^{2p} = \frac{1}{b^{2p}} \cdot b^2 = b^{2-2p}.$$

$$35.23. \text{ а) } (\sqrt[3]{3a})^9 = 27a^3; \quad \text{ б) } (5a\sqrt[3]{a})^2 = 25a^2 \cdot \sqrt[3]{a^2} = 25\sqrt[3]{a^8};$$

$$\text{ в) } (-5\sqrt[3]{a^2})^2 = 25\sqrt[3]{a^4}; \quad \text{ г) } (2\sqrt[3]{-3a^2})^5 = 32\sqrt[3]{-243a^{10}}.$$

$$35.24. \text{ а) } \sqrt[3]{x} = \sqrt[6]{x}; \quad \text{ б) } \sqrt[3]{\sqrt{a^3}} = \sqrt{a};$$

$$\text{ в) } \sqrt[5]{\sqrt[3]{a^{10}}} = \sqrt[15]{a^{10}} = \sqrt[3]{a^2}; \quad \text{ г) } \sqrt{\sqrt[3]{ab}} = \sqrt[6]{ab}.$$

$$35.25. \text{ а) } \frac{1}{2}\sqrt[3]{5x} + 13 + \frac{\sqrt[3]{5x}}{5} = 2\sqrt[3]{5x}; \quad \sqrt[3]{5x}\left(2 - \frac{1}{5} - \frac{1}{2}\right) = 13;$$

$$\sqrt[3]{5x} \frac{13}{10} = 13; \quad \sqrt[3]{5x} = 10; \quad x = 200.$$

$$\text{ б) } \sqrt[4]{2x} + \sqrt[4]{32x} + \sqrt[4]{162x} = 6; \quad \sqrt[4]{x}(\sqrt[4]{2} + 2\sqrt[4]{2} + 3\sqrt[4]{2}) = 6;$$

$$\sqrt[4]{x} \cdot 6\sqrt[4]{2} = 6; \quad \sqrt[4]{x} = \frac{1}{\sqrt[4]{2}}; \quad x = \frac{1}{2}.$$

$$35.26. \text{ а) } \sqrt[4]{6+2\sqrt{5}}\sqrt[4]{6-2\sqrt{5}} = \sqrt[4]{36-20} = 2;$$

$$\text{ б) } \sqrt[4]{6-2\sqrt{17}}\sqrt[4]{6+2\sqrt{17}} = \sqrt[4]{-32} = -2;$$

$$\text{ в) } \sqrt[3]{8-\sqrt{37}}\sqrt[3]{8+\sqrt{37}} = \sqrt[3]{64-37} = 3;$$

$$\text{ г) } \sqrt[3]{\sqrt{17}+3}\sqrt[3]{\sqrt{17}-3} = \sqrt[3]{17-9} = 2.$$

$$35.27. \text{ а) } \sqrt[3]{x} - 2\sqrt[6]{x} = 0; \quad \sqrt[6]{x}(\sqrt[6]{x} - 2) = 0; \quad x_1 = 0, \quad x_2 = 64;$$

$$\text{ б) } \sqrt{x} - 5\sqrt[4]{x} + 6 = 0 \text{ — это уравнение относительно } \sqrt[4]{x};$$

$$(\sqrt[4]{x})^2 - 5\sqrt[4]{x} + 6; \quad \sqrt[4]{x} = 2; \quad x = 16; \quad \sqrt[4]{x} = 3; \quad x = 81.$$

$$\text{ в) } \sqrt[6]{x} + 2\sqrt[3]{x} - 1 = 0; \quad \sqrt[6]{x} = \frac{-1+3}{4} = \frac{1}{2}; \quad x = \frac{1}{64};$$

$$\sqrt[6]{x} = -1 \text{ — решений нет.}$$

$$\text{ г) } \sqrt[4]{x} + 2\sqrt[8]{x} - 3 = 0; \quad \sqrt[8]{x} = -3 \text{ — решений нет; } \sqrt[8]{x} = 1; \quad x = 1.$$

$$35.28. \quad f(x) = \sqrt[7]{x}; \quad 2f(x) = 4\sqrt[7]{x}; \quad f(128x) = 2 \cdot \sqrt[7]{128x} = 4\sqrt[7]{x}.$$

$$35.29. f(x) = 2\sqrt[3]{x}; 2f(x) = 4\sqrt[3]{x}; f(32x) = 2 \cdot \sqrt[3]{32x} = 4\sqrt[3]{x}.$$

35.30. а)

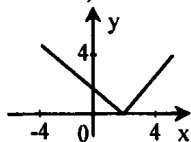

б)

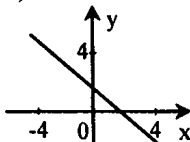

в)

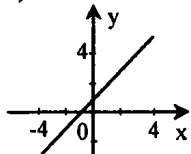

г)

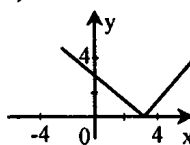

§ 36. Преобразование выражений, содержащих радикалы

36.1. а) $\sqrt{20} = 2\sqrt{5}$;

б) $\sqrt{147} = 7\sqrt{3}$;

в) $\sqrt{108} = 2 \cdot 3\sqrt{3} = 6\sqrt{3}$;

г) $\sqrt{245} = 7\sqrt{5}$.

36.2. а) $\sqrt[3]{24} = 2\sqrt[3]{3}$;

б) $\sqrt[4]{160} = 2\sqrt[4]{10}$;

в) $\sqrt[3]{512} = 8$;

г) $\sqrt[4]{486} = 3\sqrt[4]{6}$.

36.3. а) $\sqrt{x^3} = x\sqrt{x}$;

б) $\sqrt[3]{a^4} = a\sqrt[3]{a}$;

в) $\sqrt[5]{m^7} = m\sqrt[5]{m^2}$;

г) $\sqrt[4]{n^{13}} = n^3 \cdot \sqrt[4]{n}$.

36.4. а) $\sqrt{25a^3} = 5a\sqrt{a}$;

б) $\sqrt[4]{405a^5} = 3a\sqrt[4]{5a}$;

в) $\sqrt[3]{24x^3} = 2x\sqrt[3]{3}$;

г) $\sqrt[5]{160m^{10}} = 2m^2 \cdot \sqrt[5]{5}$.

36.5. а) $\sqrt{75t^4r^3} = 5t^2r\sqrt{3r}$;

б) $\frac{x^2}{b} \sqrt[3]{\frac{72a^4b^3}{343x^3}} = \frac{x^2}{b} \cdot \frac{2ab}{7x} \sqrt[3]{9a} = \frac{2}{7} xa\sqrt[3]{9a}$;

в) $\sqrt[3]{250x^4y^7} = 5xy^2\sqrt[3]{2xy}$;

г) $3mn^4 \sqrt{\frac{80x^3}{243m^5n^9}} = \frac{3mn \cdot 2}{3mn^2} \sqrt[4]{\frac{5x^3}{3mn}} = \frac{2}{n} \sqrt[4]{\frac{5x^3}{3mn}}$.

36.6. а) $\sqrt{a^2b} = |a|\sqrt{b}$;

б) $\sqrt[3]{a^3b} = a\sqrt[3]{b}$;

в) $\sqrt[4]{a^4b} = |a|\sqrt[4]{b}$;

г) $\sqrt{a^5b} = a^2 \sqrt{ab}$.

36.7. а) $2\sqrt{5} = \sqrt{20}$;

б) $6\sqrt[3]{\frac{1}{9}} = \sqrt[3]{240}$;

в) $5\sqrt{3} = \sqrt{75}$;

г) $3\sqrt[4]{\frac{5}{27}} = \sqrt{177}$.

$$36.8. \text{ a) } \frac{2}{3}\sqrt{3} = \sqrt{\frac{4}{3}};$$

$$\text{б) } \frac{1}{2}\sqrt[3]{12} = \sqrt[3]{\frac{3}{2}};$$

$$\text{в) } \frac{7}{5}\sqrt{3\frac{4}{7}} = \sqrt{\frac{49}{25} \cdot \frac{25}{7}} = \sqrt{7};$$

$$\text{г) } 0,2\sqrt[3]{25} = \sqrt[3]{\frac{1}{5}}.$$

$$36.9. \text{ a) } 7a^2\sqrt{ab} = \sqrt{49a^5b};$$

$$\text{б) } 5ab^2\sqrt[3]{a^2b} = \sqrt[3]{125a^5b^7};$$

$$\text{в) } 5x\sqrt{2x} = \sqrt{50x^3};$$

$$\text{г) } 2m\sqrt[3]{3m^2} = \sqrt[3]{24m^5}.$$

$$36.10. \text{ a) } \sqrt[3]{24} - \sqrt[3]{3} = \sqrt[3]{3}(2-1) = \sqrt[3]{3}; \quad \text{б) } 2\sqrt[3]{3} + \sqrt[3]{384} = 2\sqrt[3]{3} + 2\sqrt[3]{3} = 4\sqrt[3]{3};$$

$$\text{в) } 2\sqrt[3]{64} + \sqrt[3]{486} = 4\sqrt[3]{2} + 3\sqrt[3]{2} = 7\sqrt[3]{2}; \quad \text{г) } \sqrt[4]{512} - \sqrt[4]{2} = \sqrt[4]{2}(4-1) = 3\sqrt[4]{2}.$$

$$36.11. \text{ a) } \sqrt[3]{4}; \quad \sqrt[6]{18}; \quad \sqrt{3}; \quad \text{б) } \sqrt[3]{2}; \quad \sqrt[15]{40}; \quad \sqrt[2]{4};$$

$$\text{в) } \sqrt[3]{3}; \quad \sqrt[15]{30}; \quad \sqrt[3]{2}; \quad \text{г) } \sqrt[6]{3}; \quad \sqrt[2]{2}; \quad \sqrt[4]{4}.$$

$$36.12. \text{ a) } (\sqrt[3]{m} - 2\sqrt[3]{n})(\sqrt[3]{m} + 2\sqrt[3]{n}) = \sqrt[3]{m^2} - 4\sqrt[3]{n^2};$$

$$\text{б) } (\sqrt[3]{5} - \sqrt{3})(\sqrt{3} + \sqrt[3]{5}) = \sqrt[3]{25} - 3;$$

$$\text{в) } (a - \sqrt{b})(a + \sqrt{b}) = a^2 - b;$$

$$\text{г) } (\sqrt[3]{4} + 2\sqrt{2})(2\sqrt{2} - \sqrt[3]{4}) = 8 - \sqrt[3]{16} = 8 - 2\sqrt[3]{2}.$$

$$36.13. \text{ a) } (\sqrt{x} + \sqrt{y})(x - \sqrt{xy} + y) = (\sqrt{x})^3 + (\sqrt{y})^3 = \sqrt{x^3} + \sqrt{y^3};$$

$$\text{б) } (3 + \sqrt[4]{a})(9 - 3\sqrt{a} + \sqrt{a}) = 3^3 + (\sqrt[4]{a})^3 = 27 + \sqrt[4]{a^3};$$

$$\text{в) } (2\sqrt{p} + \sqrt{q})(4p - 2\sqrt{pq} + q) = (2\sqrt{p})^3 + (\sqrt{q})^3 = 8\sqrt{p^3} + \sqrt{q^3};$$

$$\text{г) } (\sqrt[3]{a} + \sqrt[6]{ab} + \sqrt[3]{b})(\sqrt[6]{a} - \sqrt[6]{b}) = (\sqrt[6]{a})^3 - (\sqrt[6]{b})^3 = \sqrt{a} - \sqrt{b}.$$

$$36.14. \text{ a) } (\sqrt[3]{m} - 2\sqrt[3]{n})^2 = \sqrt[3]{m^2} - 4\sqrt[3]{mn} + 4\sqrt[3]{n^2};$$

$$\text{б) } (\sqrt[3]{5} - \sqrt{3})^2 = \sqrt[3]{25} - 2\sqrt{3}\sqrt[3]{5} + 3;$$

$$\text{в) } (a^2 - \sqrt{a})^2 = a^4 + a - 2a^2\sqrt{a};$$

$$\text{г) } (\sqrt[3]{4} + 2\sqrt{2})^2 = 2\sqrt[3]{2} + 8 + 4\sqrt{2}\sqrt[3]{4}.$$

$$36.15. \text{ a) } (a-b) : (\sqrt{a} - \sqrt{b}) = \frac{(a-b)(\sqrt{a} + \sqrt{b})}{a-b} = \sqrt{a} + \sqrt{b};$$

$$\text{б) } \frac{k+l}{\sqrt[3]{k} + \sqrt[3]{l}} = \frac{k+l}{k+l} (\sqrt[3]{k^2} - \sqrt[3]{kl} + \sqrt[3]{l^2}) = \sqrt[3]{k^2} + \sqrt[3]{l^2} - \sqrt[3]{kl};$$

$$b) \frac{m-n}{\sqrt[3]{m}-\sqrt[3]{n}} = \sqrt[3]{m^2} + \sqrt[3]{n^2} + \sqrt[3]{mn};$$

$$r) \frac{x-4y}{\sqrt{x}+2\sqrt{y}} = \sqrt{x}-2\sqrt{y};$$

$$36.16. a) \frac{\sqrt{10b}-\sqrt{15}}{\sqrt{15b}-\sqrt{5}} = \frac{\sqrt{2b}-\sqrt{3}}{\sqrt{3b}-1}; \quad b) \frac{\sqrt[3]{x^2}-\sqrt[3]{xy}}{\sqrt[3]{x}-\sqrt[3]{xy}} = \frac{\sqrt[3]{x}-\sqrt[3]{y}}{1-\sqrt[3]{y}};$$

$$b) \frac{\sqrt[4]{14}+\sqrt[4]{21k}}{\sqrt[4]{7k}-\sqrt[4]{14}} = \frac{\sqrt[4]{2}+\sqrt[4]{3k}}{\sqrt[4]{k}-\sqrt[4]{2}}; \quad r) \frac{\sqrt[4]{a^2}-\sqrt[4]{ad}}{\sqrt[4]{3a}-\sqrt[4]{a^2d}} = \frac{\sqrt[4]{a}-\sqrt[4]{d}}{\sqrt[4]{3}-\sqrt[4]{ad}}.$$

$$36.17. a) \frac{\sqrt{a}-2\sqrt[4]{a}\sqrt[3]{b}+\sqrt[3]{b^2}}{\sqrt[4]{a}-\sqrt[3]{b}} = \frac{(\sqrt[4]{a}-\sqrt[3]{b})^2}{\sqrt[4]{a}-\sqrt[3]{b}} = \sqrt[4]{a}-\sqrt[3]{b};$$

$$b) \frac{\sqrt[3]{m}+2\sqrt[3]{n}}{4\sqrt[3]{n^2}+4\sqrt[3]{mn}+\sqrt[3]{m^2}} = \frac{1}{2\sqrt[3]{n}+\sqrt[3]{m}};$$

$$b) \frac{\sqrt[4]{a}+\sqrt{b}}{\sqrt{a}+2\sqrt[4]{a^2b}+b} = \frac{1}{\sqrt[4]{a}+\sqrt{b}};$$

$$r) \frac{\sqrt{b}+2a\sqrt[4]{a^2b}+a^3}{a\sqrt{a}+\sqrt[4]{b}} = \frac{(a\sqrt{a}+\sqrt[4]{b})^2}{a\sqrt{a}+\sqrt[4]{b}} = a\sqrt{a}+\sqrt[4]{b};$$

$$36.18. a) \frac{\sqrt{a}-\sqrt[3]{b^2}}{\sqrt[4]{a}-\sqrt[3]{b}} = \sqrt[4]{a}+\sqrt[3]{b}; \quad b) \frac{\sqrt[5]{x^9}-1}{\sqrt[5]{x^3}-1} = x^2\sqrt{x}+\sqrt[5]{x^3}+1;$$

$$b) \frac{\sqrt{b}-a^3}{a\sqrt{a}+\sqrt[4]{b}} = \sqrt[4]{b}-a\sqrt{a}; \quad r) \frac{\sqrt{a}-b\sqrt{b}}{\sqrt[5]{a}-\sqrt{b}} = \sqrt[5]{a}+\sqrt[6]{ab^3}+b.$$

$$36.19. a) \sqrt[4]{2^3\sqrt{2m^4n^8}} = \sqrt[4]{3\sqrt{2^4m^4n^8}} = \sqrt[3]{2mn^2};$$

$$b) \sqrt{y}\sqrt[5]{9x^4y^2} = \sqrt[5]{9x^4y^7} = \sqrt[10]{9x^4y^7};$$

$$b) \sqrt[5]{4\sqrt[3]{k^2l^5}} = \sqrt[5]{3\sqrt[3]{64k^2l^5}} = \sqrt[15]{64k^2l^5};$$

$$r) \sqrt[7]{q}\sqrt[5]{2p^3q} = \sqrt[7]{5\sqrt[5]{2p^3q^6}} = \sqrt[35]{2p^3q^6}.$$

$$36.20. a) \sqrt[5]{2\sqrt[3]{2\sqrt{2}}} = \sqrt[5]{3\sqrt[3]{16\sqrt{2}}} = \sqrt[5]{3\sqrt[5]{512}} = \sqrt[10]{8};$$

$$b) \sqrt[4]{\frac{4}{3}\sqrt[3]{\frac{3}{4}\sqrt{\frac{4}{3}}}} = \sqrt[4]{3\sqrt[3]{\left(\frac{4}{3}\right)^2\sqrt{\frac{4}{3}}}} = \sqrt[4]{3\sqrt[3]{\left(\frac{4}{3}\right)^5}} = \sqrt[24]{\frac{1024}{243}};$$

$$b) \sqrt[3]{\frac{2}{3}\sqrt[3]{\frac{3}{2}\sqrt{\frac{2}{3}}}} = \sqrt[3]{3\sqrt[3]{\left(\frac{2}{3}\right)^2\sqrt{\frac{2}{3}}}} = \sqrt[3]{3\sqrt[3]{\left(\frac{2}{3}\right)^5}} = \sqrt[18]{\frac{32}{243}};$$

$$r) \sqrt{3\sqrt{3\sqrt{3}}} = \sqrt{4\sqrt{3^5\sqrt{3}}} = \sqrt{4\sqrt{3^6}} = \sqrt{3^2} = 3.$$

$$36.21. a) \sqrt{50} - \sqrt[3]{3} - 6\sqrt{2} + \sqrt[3]{24} + \sqrt{8} = 5\sqrt{2} - \sqrt[3]{3} - 6\sqrt{2} + 2\sqrt[3]{3} + 2\sqrt{2} = \sqrt{2} + \sqrt[3]{3};$$

$$b) 6\sqrt[4]{x} + \sqrt{xy} - \sqrt{xy} - \sqrt[8]{x^2} + \frac{7}{x}\sqrt{x^3y} = 6\sqrt[4]{x} + \sqrt{xy} - 3\sqrt{xy} - \sqrt[4]{x} + 7\sqrt{xy} = 8\sqrt{xy} - 3\sqrt{xy} + 5\sqrt[4]{x} = 5\sqrt{xy} + 5\sqrt[4]{x}.$$

$$36.22. a) -\sqrt[3]{2\sqrt[4]{10}} \vee -\sqrt[4]{\sqrt[3]{99}}; -\sqrt[20]{160} < -\sqrt[20]{99}.$$

$$b) \sqrt{2\sqrt[3]{3}} \vee \sqrt[3]{5}; \sqrt[6]{24} \vee \sqrt[3]{5}; \sqrt[6]{24} < \sqrt[6]{25}.$$

$$b) \sqrt[4]{3} \vee \sqrt[8]{6\sqrt{2}}; \sqrt[16]{81} > \sqrt[16]{72};$$

$$r) -\sqrt{2\sqrt[3]{6}} \vee -\sqrt[3]{5\sqrt{2}}; -\sqrt[6]{48} > -\sqrt[6]{50}.$$

$$36.23. a) \sqrt[3]{5\sqrt{3}}; \sqrt[6]{100}; \sqrt{3\sqrt[3]{4}};$$

$$b) \sqrt[3]{3\sqrt[3]{3}}; \sqrt[3]{4}; \sqrt[10]{25};$$

$$b) \sqrt[3]{2}; \sqrt[3]{2\sqrt[3]{2}}; \sqrt[3]{3\sqrt{4}};$$

$$r) \sqrt[48]{7\sqrt{7}}; \sqrt[4]{2\sqrt{1,25}}; \sqrt[16]{64};$$

$$36.24. a) \frac{4-3\sqrt{2}}{(\sqrt[4]{2}-\sqrt[4]{8})^2} = \frac{4-3\sqrt{2}}{\sqrt{2}+\sqrt{8}-4} = \frac{4-\sqrt{2}-\sqrt{8}}{\sqrt{2}+\sqrt{8}-4} = -1;$$

$$b) \frac{(\sqrt[4]{24} + \sqrt[4]{6})^2}{4\sqrt{3} + 3\sqrt{6}} = \frac{\sqrt{24} + \sqrt{6} + 2\sqrt{12}}{\sqrt{24} + \sqrt{6} + 2\sqrt{12}} = 1;$$

$$b) \frac{(\sqrt[3]{9} + \sqrt{3})^2}{\sqrt[3]{3} + 2\sqrt[6]{3} + 1} = \frac{(\sqrt[3]{9} + \sqrt{3})^2}{(\sqrt[6]{3} + 1)^2} = 3;$$

$$r) \frac{1-2\sqrt[4]{5} + \sqrt{5}}{(\sqrt{3} - \sqrt[4]{45})^2} = \frac{(1-\sqrt[4]{5})^2}{(\sqrt{3} - \sqrt[4]{45})^2} = \frac{1}{3}.$$

$$36.25. a) (1+\sqrt{a})(1+\sqrt[4]{a})(1-\sqrt[4]{a}) = (1+\sqrt{a})(1-\sqrt{a}) = 1-a;$$

$$b) (\sqrt{m} + \sqrt{n})(\sqrt[4]{m} - \sqrt[4]{n})(\sqrt[4]{m} + \sqrt[4]{n}) = (\sqrt{m} + \sqrt{n})(\sqrt{m} - \sqrt{n}) = m-n.$$

$$36.26. a) \frac{(\sqrt[3]{9a^2x} - 2\sqrt[3]{3abx} + \sqrt[3]{b^2x})}{\sqrt[3]{3a} - \sqrt[3]{b}} = \frac{\sqrt[3]{x}(\sqrt[3]{3a} - \sqrt[3]{b})^2}{\sqrt[3]{3a} - \sqrt[3]{b}} = \sqrt[3]{x}(\sqrt[3]{3a} - \sqrt[3]{b});$$

$$b) \frac{\sqrt[3]{16x^2} - \sqrt[3]{25y^2}}{\sqrt[3]{4x} - \sqrt[3]{5y}} = \sqrt[3]{4x} + \sqrt[3]{5y}.$$

$$36.27. \text{ a) } \sqrt{2x} - \sqrt{3y} + \sqrt{2y} - \sqrt{3x} = \sqrt{x}(\sqrt{2} - \sqrt{3}) + \sqrt{y}(\sqrt{2} - \sqrt{3}) =$$

$$= (\sqrt{2} - \sqrt{3})(\sqrt{x} + \sqrt{y});$$

$$\text{б) } \sqrt[3]{4x^2} + \sqrt[4]{2\sqrt[3]{x^2}} - \sqrt[3]{4\sqrt[4]{y^3}} - \sqrt[4]{2y^3} = \sqrt[3]{x^2}(\sqrt[3]{4} + \sqrt[4]{2}) - \sqrt[4]{y^3}(\sqrt[3]{4} + \sqrt[4]{2}) =$$

$$= (\sqrt[3]{x^2} - \sqrt[4]{y^3})(\sqrt[3]{4} + \sqrt[4]{2});$$

$$\text{в) } \sqrt[3]{a^4} + \sqrt[3]{ab^3} - \sqrt[3]{a^3b} - \sqrt[3]{b^4} = \sqrt[3]{a}(a+b) - \sqrt[3]{b}(a+b) = (a+b)(\sqrt[3]{a} - \sqrt[3]{b});$$

$$\text{г) } b\sqrt{a} - ab + \sqrt{ab} - ab\sqrt{b} = b\sqrt{a}(1 - \sqrt{ab}) + \sqrt{ab}(1 - \sqrt{ab}) =$$

$$= (1 - \sqrt{ab})(b\sqrt{a} + \sqrt{ab}) = \sqrt{ab}(1 - \sqrt{ab})(1 + \sqrt{b}).$$

36.28. Рассматриваем данные выражения как квадратные трехчлены и находим их корни:

$$\text{а) } \sqrt[4]{m} - \sqrt[8]{m} - 6 = (\sqrt[8]{m} - 3)(\sqrt[8]{m} + 2); \text{ б) } \sqrt{m} + 5\sqrt[4]{m} + 6 = (\sqrt[4]{m} + 2)(\sqrt[4]{m} + 3);$$

$$\text{в) } \sqrt[5]{a} + 7\sqrt[10]{a} + 12 = (\sqrt[10]{a} + 4)(\sqrt[10]{a} + 3);$$

$$\text{г) } 2\sqrt[3]{x} - \sqrt[6]{x} - 1; \sqrt[6]{x} = \frac{1 \pm \sqrt{1 - 4 \cdot 2(-1)}}{4} = \frac{1 \pm 3}{4}; \sqrt[6]{x} = 1; \sqrt[6]{x} = -\frac{1}{2} \Rightarrow$$

$$2\sqrt[3]{x} - \sqrt[6]{x} - 1 = 2(\sqrt[6]{x} - 1)\left(\sqrt[6]{x} + \frac{1}{2}\right) = (\sqrt[6]{x} - 1)(2\sqrt[6]{x} + 1).$$

$$36.29. \text{ а) } \frac{6\sqrt[3]{x^2} + \sqrt[3]{x} - 1}{2\sqrt[3]{x^2} + \sqrt[3]{x}} = \frac{(2\sqrt[3]{x} + 1)(3\sqrt[3]{x} - 1)}{\sqrt[3]{x}(2\sqrt[3]{x} + 1)} = 3 - \frac{1}{\sqrt[3]{x}};$$

$$\text{б) } \frac{3\sqrt{x} - 5\sqrt[4]{x} - 2}{9\sqrt{x} - 1} = \frac{(\sqrt{x} - 2)(3\sqrt[4]{x} + 1)}{(3\sqrt[4]{x} - 1)(3\sqrt[4]{x} + 1)} = \frac{\sqrt{x} - 2}{3\sqrt[4]{x} - 1}.$$

$$36.30. \text{ а) } \frac{\sqrt{ab}\sqrt[4]{a}}{(a+b)\sqrt[4]{\frac{b^2}{a}}} - \frac{a^2 + b^2}{(a^2 - b^2)} = \frac{\sqrt{ab} \cdot \sqrt[4]{a} \cdot \sqrt[4]{a}}{(a+b)\sqrt{b}} - \frac{a^2 + b^2}{(a+b)(a-b)} =$$

$$= -\frac{b(a+b)}{(a+b)(a-b)} = -\frac{b}{a-b};$$

$$\text{б) } \frac{(\sqrt[4]{m} + \sqrt[4]{n})^2 + (\sqrt[4]{m} - \sqrt[4]{n})^2}{2(m-n)} : \frac{1}{\sqrt{m^3} - \sqrt{n^3}} - 3\sqrt{mn} =$$

$$= \frac{2(\sqrt{m} + \sqrt{n})}{2(\sqrt{m} - \sqrt{n})(\sqrt{m} + \sqrt{n})} \cdot (\sqrt{m} - \sqrt{n})(m + n + \sqrt{mn}) - (3\sqrt{mn}) =$$

$$= m + n - 2\sqrt{mn} = (\sqrt{m} - \sqrt{n})^2;$$

$$36.31. \text{ а) } \frac{x\sqrt[3]{x}-1}{\sqrt[3]{x^2}-1} - \frac{\sqrt[3]{x^2}-1}{\sqrt[3]{x}+1} = 4;$$

$$\frac{\sqrt[3]{x^4}-1}{\sqrt[3]{x^2}-1} - \frac{(\sqrt[3]{x}-1)(\sqrt[3]{x}+1)}{\sqrt[3]{x}+1} = \frac{(\sqrt[3]{x^2}-1)(\sqrt[3]{x^2}+1)}{\sqrt[3]{x^2}-1} - (\sqrt[3]{x}-1) = \sqrt[3]{x^2}+1 - \sqrt[3]{x}+1;$$

$$\sqrt[3]{x^2}+1 - \sqrt[3]{x}+1 = 4; \sqrt[3]{x^2} - \sqrt[3]{x} - 2 = 0; \sqrt[3]{x} = 2, x = 8; \sqrt[3]{x} = -1, x = -1.$$

$x = -1$ не подходит, т.к. знаменатель обращается в 0, т.е. $x = -1$ не входит в ОДЗ.

Ответ: $x = 8$.

$$\text{б) } \frac{x+8}{\sqrt[3]{x}+2} + \frac{\sqrt[3]{x^2}-25}{\sqrt[3]{x}+5} = 5; \frac{(\sqrt[3]{x}+2)(\sqrt[3]{x^2}-2\sqrt[3]{x}+4)}{\sqrt[3]{x}+2} + \frac{(\sqrt[3]{x}-5)(\sqrt[3]{x}+5)}{\sqrt[3]{x}+5};$$

$$\sqrt[3]{x^2} - 2\sqrt[3]{x} + 4 + \sqrt[3]{x} - 5 = 5; \sqrt[3]{x^2} - \sqrt[3]{x} - 6 = 0; \sqrt[3]{x} = 3, x = 27;$$

$$\sqrt[3]{x} = -2, x = -8 - \text{ не входит в ОДЗ.}$$

Ответ: $x = 27$.

§ 37. Обобщение понятия о показателе степени

$$37.1. \text{ а) } c^{\frac{3}{4}} = \sqrt[4]{c^3}; \text{ б) } p^{5\frac{1}{2}} = \sqrt{p^{11}}; \text{ в) } x^{\frac{3}{4}} = \sqrt[4]{x^3}; \text{ г) } y^{\frac{2}{3}} = \sqrt[3]{y^2}.$$

$$37.2. \text{ а) } 0,2^{0,5} = \sqrt{\frac{1}{5}}; \text{ б) } t^{0,8} = \sqrt[5]{t^4}; \text{ в) } b^{1,5} = \sqrt{b^3}; \text{ г) } 8,5^{0,6} = \sqrt[5]{8,5^3}.$$

$$37.3. \text{ а) } \sqrt{1,3} = 1,3^{\frac{1}{2}}; \text{ б) } \sqrt[7]{\frac{3}{5}} = 0,6^{\frac{1}{7}}; \text{ в) } \sqrt[4]{\frac{2}{3}} = \left(\frac{2}{3}\right)^{\frac{1}{4}}; \text{ г) } \sqrt[3]{4,3} = 4,3^{\frac{1}{3}}.$$

$$37.4. \text{ а) } \sqrt[5]{b^4} = b^{\frac{4}{5}}; \text{ б) } \sqrt[3]{a^2} = a^{\frac{2}{3}}; \text{ в) } \sqrt[11]{c^2} = c^{\frac{2}{11}}; \text{ г) } \sqrt[5]{a} = a^{\frac{1}{5}}.$$

$$37.5. \text{ а) } 49^{\frac{1}{2}} = 7; \text{ б) } 1000^{\frac{1}{3}} = 10; \text{ в) } 27^{\frac{1}{3}} = 3; \text{ г) } 25^{\frac{1}{2}} = 5.$$

$$37.6. \text{ а) } 9^{2\frac{1}{2}} = 3^5 = 243; \quad \text{б) } 0,16^{\frac{1}{2}} = 0,064;$$

$$\text{в) } \left(3\frac{3}{8}\right)^{\frac{4}{3}} = \left(\frac{3}{2}\right)^4 = \frac{81}{16}; \quad \text{г) } 0,001^{\frac{2}{3}} = 0,01.$$

$$37.7. \text{ а) } \frac{a^5 a^{-8}}{a^{-2}} = a^{-1}; a = 6, a^{-1} = \frac{1}{6}; \quad \text{б) } \frac{b^{-9}}{(b^2)^{-3}} = b^{-3}; b = \frac{1}{2}, b^{-3} = 8;$$

$$\text{в) } \frac{p^{-9}}{p^{-2} p^{-5}} = p^{-2}; p = \frac{1}{2}, p^{-2} = 4; \quad \text{г) } (t^{-3})^2 \frac{1}{t^{-5}} = t^{-1}; t = 0,1, t^{-1} = 10;$$

$$37.8. \text{ a) } (27 \cdot 3^{-4})^2 = \frac{1}{9};$$

$$\text{б) } 16 \cdot (2^{-3})^2 = \frac{1}{4}.$$

$$37.9. \text{ a) } \frac{6^{-4} \cdot 6^{-9}}{6^{-12}} = 6^{-1} = \frac{1}{6};$$

$$\text{б) } \frac{7^{-7} \cdot 7^{-8}}{7^{-13}} = 7^{-2} = \frac{1}{49}.$$

$$37.10. \text{ a) } \frac{5^4 \cdot 49^{-3}}{7^{-7} \cdot 25^3} = 5^{-2} \cdot 7^1 = \frac{7}{25};$$

$$\text{б) } \frac{81^{12} \cdot 10^{-7}}{10^{-5} \cdot 27^{17}} = 3^{-3} \cdot 10^{-2} = \frac{1}{2700}.$$

$$37.11. \text{ a) } \sqrt{b^{-1}} = b^{-\frac{1}{2}}; \text{ б) } \sqrt[12]{b^{-5}} = b^{-\frac{5}{12}}; \text{ в) } \frac{1}{\sqrt[4]{x^{-3}}} = x^{\frac{3}{4}}; \text{ г) } \frac{1}{\sqrt[3]{a^{-2}}} = a^{\frac{2}{3}}.$$

$$37.12. \text{ a) } 4^{\frac{1}{2}} = \frac{1}{2}; \text{ б) } 8^{\frac{1}{3}} = \frac{1}{2}; \text{ в) } 32^{\frac{1}{5}} = \frac{1}{2}; \text{ г) } 16^{\frac{1}{4}} = \frac{1}{2}.$$

$$37.13. \text{ a) } 5^{\frac{4}{3}} \text{ Да.}$$

$$\text{б) } (-16)^{\frac{2}{3}} \text{ Нет.}$$

$$\text{в) } 23^{\frac{1}{5}} \text{ Да.}$$

$$\text{г) } (-25)^{-\frac{1}{2}} \text{ Нет.}$$

$$37.14. \text{ a) } 2^{\frac{1}{2}} < 3^{\frac{1}{2}}; \text{ б) } 0,3^{\frac{1}{2}} < 0,5^{\frac{1}{2}}; \text{ в) } 5^{\frac{1}{2}} > 5^{\frac{1}{3}}; \text{ г) } 7^{\frac{1}{3}} = 7^{\frac{2}{6}}.$$

$$37.15. \text{ a) } c^{\frac{1}{2}} c^{\frac{1}{3}} = c^{\frac{5}{6}}; \text{ б) } b^{-\frac{1}{3}} b^{\frac{1}{2}} = b^{\frac{1}{6}}; \text{ в) } a^{\frac{2}{3}} a^{\frac{1}{6}} = a^{\frac{1}{2}}; \text{ г) } d^5 d^{\frac{1}{2}} = d^{\frac{11}{2}}.$$

$$37.16. \text{ a) } x^{\frac{1}{2}} : x^{\frac{3}{2}} = \frac{1}{x};$$

$$\text{б) } y^{\frac{5}{6}} : y^{\frac{1}{3}} = y^{\frac{7}{6}};$$

$$\text{в) } z^{\frac{1}{5}} : z^{-\frac{1}{2}} = z^{\frac{7}{10}};$$

$$\text{г) } m^{\frac{1}{3}} : m^2 = m^{-\frac{5}{3}}.$$

$$37.17. \text{ a) } (b^{1/2})^{\frac{1}{3}} = b^{\frac{1}{6}};$$

$$\text{б) } (c^{-1/2})^{\frac{1}{2}} = c^{-\frac{1}{4}};$$

$$\text{в) } \left(a^{\frac{3}{2}}\right)^{\frac{4}{3}} = a^2;$$

$$\text{г) } \left(p^{-\frac{3}{4}}\right)^{\frac{2}{9}} = p^{\frac{1}{6}}.$$

$$37.18. \text{ a) } x^{\frac{1}{2}} \sqrt{x} = x; \text{ б) } y^{\frac{7}{3}} \sqrt[3]{y^2} = y^3; \text{ в) } z^{\frac{3}{4}} z^{\frac{1}{4}} = z; \text{ г) } \sqrt[4]{c^3 c^4} = c.$$

$$37.19. \text{ a) } (a^{0,4})^{\frac{1}{2}} a^{0,8} = a^{\frac{1}{5}} a^{\frac{4}{5}} = a; \text{ б) } \sqrt[10]{c} (c^{-1,2})^{\frac{3}{4}} = c^{\frac{1}{10}} c^{-\frac{9}{10}} = c^{-\frac{4}{5}};$$

$$\text{в) } \left(x^{\frac{3}{4}}\right)^{\frac{5}{4}} \left(\sqrt[4]{x}\right)^{\frac{17}{4}} = x^{\frac{15}{16}} x^{\frac{17}{16}} = x^2; \text{ г) } (b^{0,8})^{-\frac{3}{4}} \left(b^{-\frac{2}{5}}\right)^{-1,5} = b^{-\frac{3}{5}} b^{\frac{3}{5}} = b^0 = 1.$$

$$37.20. \text{ a) } 10^{\frac{2}{5}} \cdot 10^{\frac{1}{2}} \cdot 10^{0,1} = 10;$$

$$\text{б) } 2^{1,3} \cdot 2^{-0,7} \cdot 4^{0,7} = 4;$$

$$b) 49^{\frac{2}{3}} \cdot 7^{\frac{1}{12}} \cdot 7^{\frac{3}{4}} = 7^{\frac{16}{12} + \frac{1}{12} + \frac{9}{12}} = \frac{1}{49};$$

$$r) 25^{0.3} \cdot 5^{1.4} \cdot 625^{0.25} = 25 \cdot 5 = 125.$$

$$37.21. a) 4^{0.6} \cdot 2^{0.2} \cdot 2^{-0.6} = 2^{1.2} \cdot 2^{0.2} \cdot 2^{0.6} = 4$$

$$b) 3 \cdot 9^{0.4} : \sqrt[5]{3^{-1}} = 3^{1+0.8+\frac{1}{5}} = 9;$$

$$b) 4^{\frac{1}{3}} \cdot 2^{\frac{2}{3}} : 4^{-\frac{1}{3}} = 4^{\frac{1}{3} + \frac{2}{3} + \frac{1}{3}} = 4^{\frac{4}{3}} = 8;$$

$$r) 8^{-\frac{1}{3}} \cdot 16^{\frac{1}{3}} : \sqrt[3]{2} = 2^{-1 + \frac{4}{3} - \frac{1}{3}} = 1.$$

$$37.22. a) (27 \cdot 64)^{1/3} = 3 \cdot 4 = 12; \quad b) \left(\frac{1}{16} \cdot 81^{-1}\right)^{-1/4} = 2 \cdot 3 = 6;$$

$$b) \left(\frac{1}{36} \cdot 0.04\right)^{-1/2} = 6 \cdot 5 = 30; \quad r) \left(5^{-3} \cdot \frac{1}{64}\right)^{-1/3} = 5 \cdot 4 = 20;$$

$$37.23. a) (m^{-3})^{1/3} = \frac{1}{m}; \quad b) \left(8x^{-1/2}\right)^{2/3} = 4x^{-1} = \frac{4}{x};$$

$$b) \left(x^{-\frac{3}{4}}\right)^{-(2/3)} = \sqrt{x}; \quad r) (81x^{-4})^{\frac{3}{4}} = \frac{x^3}{27}.$$

$$37.24. a) \frac{x^{\frac{2}{3}} \cdot x^{\frac{5}{3}}}{x^{\frac{3}{5}}} = x^{\frac{2}{5}}; \quad b) \frac{y^{\frac{6}{7}} \cdot \left(y^{-\frac{1}{2}}\right)^2}{(y^7)^{-2}} = y^{\frac{6}{7}} y^{-1} y^{\frac{8}{7}} = y;$$

$$b) \frac{(c^{-\frac{2}{3}})^{-4}}{c^{\frac{1}{6}} \cdot c^{\frac{1}{2}}} = c^{\frac{8}{3} - \frac{1}{6} - \frac{1}{2}} = c^2; \quad r) \left(\frac{\frac{1}{a^2} \cdot b^3}{\frac{1}{a^4} b^5}\right)^{20} = a^5 b^4.$$

$$37.25. a) \left(x^{\frac{1}{2}} - y^{\frac{1}{2}}\right) x^{\frac{1}{2}} y^{\frac{1}{2}} = xy^{\frac{1}{2}} - yx^{\frac{1}{2}}; \quad b) a^{\frac{2}{3}} b^{\frac{2}{3}} (a^{\frac{1}{3}} + b^{\frac{1}{3}}) = ab^{\frac{2}{3}} + ba^{\frac{2}{3}};$$

$$b) b^{\frac{1}{3}} c^{\frac{1}{4}} (b^{\frac{2}{3}} + c^{\frac{3}{4}}) = bc^{\frac{1}{4}} + cb^{\frac{1}{3}}; \quad r) x^{\frac{1}{2}} y^{\frac{1}{2}} (x^{\frac{1}{2}} - y^{\frac{3}{2}}) = xy^{\frac{1}{2}} - y^2 x^{\frac{1}{2}}.$$

$$37.26. a) \left(m^{\frac{1}{2}} + n^{\frac{1}{2}}\right)^2 = m + n + 2\sqrt{mn} \quad b) \left(1 - c^{\frac{1}{3}}\right)^2 = 1 + c^{\frac{2}{3}} - 2c^{\frac{1}{3}}$$

$$b) \left(1 + b^{\frac{1}{2}}\right)^2 = 1 + b + 2b^{\frac{1}{2}} \quad r) \left(a^{\frac{1}{2}} - 2b^{\frac{1}{2}}\right)^2 = a + 4b - 4\sqrt{ab}$$

$$37.27. a) \left(x^{\frac{1}{3}} + 3\right) \left(x^{\frac{1}{3}} - 3\right) = x^{\frac{2}{3}} - 9; \quad b) \left(a^{\frac{1}{2}} + b^{\frac{1}{2}}\right) \left(a - a^{\frac{1}{2}} b^{\frac{1}{2}} + b\right) = a^{1.5} + b^{1.5};$$

$$b) \left(d^{\frac{1}{2}} - 1\right)\left(d^{\frac{1}{2}} + 1\right) = d - 1;$$

$$r) \left(p^{\frac{1}{3}} - q^{\frac{1}{3}}\right)\left(p^{\frac{2}{3}} + (pq)^{\frac{1}{3}} + q^{\frac{2}{3}}\right) = p - q.$$

$$37.28. a) \frac{4 \cdot 3^{\frac{1}{2}}}{\frac{1}{3^2} - 3} = \frac{4}{1 - 3^{\frac{1}{2}}};$$

$$b) \frac{a^{\frac{1}{2}} - b^{\frac{1}{2}}}{a - b} = \frac{1}{a^{\frac{1}{2}} + b^{\frac{1}{2}}};$$

$$b) \frac{x + x^{\frac{1}{2}}}{2x} = \frac{x^{\frac{1}{2}} + 1}{2x^{\frac{1}{2}}};$$

$$r) \frac{p^{\frac{1}{2}} - 5}{p - 25} = \frac{1}{p^{\frac{1}{2}} + 5}.$$

$$37.29. a) \frac{c + c^{\frac{1}{2}}d^{\frac{1}{2}} + d}{\frac{3}{c^2} - d^{\frac{1}{2}}} = \frac{1}{\frac{1}{c^2} - d^{\frac{1}{2}}};$$

$$b) \frac{m + n}{m^{\frac{2}{3}} - (mn)^{\frac{1}{3}} + n^{\frac{2}{3}}} = m^{\frac{1}{3}} + n^{\frac{1}{3}}.$$

$$37.30. a) (1 + c^{\frac{1}{2}})^2 - 2c^{\frac{1}{2}} = 1 + c + 2c^{\frac{1}{2}} - 2c^{\frac{1}{2}} = 1 + c;$$

$$b) \left(m^{\frac{1}{4}} - m^{\frac{1}{3}}\right)^2 + 2m^{\frac{7}{12}} = m^{\frac{1}{2}} + m^{\frac{2}{3}} - 2m^{\frac{7}{12}} - 2m^{\frac{7}{12}} = m^{\frac{1}{2}} + m^{\frac{2}{3}};$$

$$b) \left(x^{\frac{1}{2}} - y^{\frac{1}{2}}\right)^2 + 2x^{\frac{1}{2}}y^{\frac{1}{2}} = x + y;$$

$$r) \sqrt{b} + \sqrt{c} - \left(b^{\frac{1}{4}} + c^{\frac{1}{4}}\right)^2 = \sqrt{b} + \sqrt{c} - \sqrt{b} - \sqrt{c} - 2\sqrt[4]{bc} = -2\sqrt[4]{bc}.$$

$$37.31. a) \left(a^{\frac{1}{3}} + b^{\frac{1}{3}}\right)^2 - \left(a^{\frac{1}{3}} - b^{\frac{1}{3}}\right)^2 = a^{\frac{2}{3}} + b^{\frac{2}{3}} + 2\sqrt[3]{ab} - a^{\frac{2}{3}} - b^{\frac{2}{3}} + 2\sqrt[3]{ab} = 4\sqrt[3]{ab};$$

$$b) \left(a^{\frac{3}{2}} + 5a^{\frac{1}{2}}\right)^2 - 10a^2 = a^3 + 25a.$$

$$37.32. a) \left(x^{\frac{1}{4}} + 1\right)\left(x^{\frac{1}{4}} - 1\right)\left(x^{\frac{1}{2}} + 1\right) = (x^{\frac{1}{2}} - 1)(x^{\frac{1}{2}} + 1) = x - 1;$$

$$b) \left(k^{\frac{1}{4}} + l^{\frac{1}{4}}\right)\left(k^{\frac{1}{8}} + l^{\frac{1}{8}}\right)\left(k^{\frac{1}{8}} - l^{\frac{1}{8}}\right) = \left(k^{\frac{1}{4}} + l^{\frac{1}{4}}\right)\left(k^{\frac{1}{4}} - l^{\frac{1}{4}}\right) = k^{\frac{1}{2}} - l^{\frac{1}{2}}.$$

$$37.33. a) \frac{a - b}{\frac{1}{a^2} - b^{\frac{3}{2}}} - \frac{a^{\frac{3}{2}} - b^{\frac{3}{2}}}{a - b} =$$

$$= \frac{\left(\frac{1}{a^2} - b^{\frac{1}{2}}\right)\left(\frac{1}{a^2} + b^{\frac{1}{2}}\right)}{\frac{1}{a^2} - b^{\frac{1}{2}}} - \frac{\left(\frac{1}{a^2} - b^{\frac{1}{2}}\right)\left(a + a^{\frac{1}{2}}b^{\frac{1}{2}} + b^{\frac{1}{2}}\right)}{\left(\frac{1}{a^2} - b^{\frac{1}{2}}\right)\left(\frac{1}{a^2} + b^{\frac{1}{2}}\right)} =$$

$$= a^{\frac{1}{2}} + b^{\frac{1}{2}} - \frac{a+b+(ab)^{\frac{1}{2}}}{a^{\frac{1}{2}}+b^{\frac{1}{2}}} = \frac{a+b+2a^{\frac{1}{2}}b^{\frac{1}{2}}-a-b-a^{\frac{1}{2}}b^{\frac{1}{2}}}{a^{\frac{1}{2}}+b^{\frac{1}{2}}} = \frac{\sqrt{ab}}{\sqrt{a}+\sqrt{b}};$$

$$6) \frac{\sqrt{x}}{x^2+y^2} + \frac{\sqrt{y}}{x^2-y^2} = \frac{x-(xy)^{\frac{1}{2}}+(xy)^{\frac{1}{2}}+y}{x-y} = \frac{x+y}{x-y}$$

§ 38. Степенные функции, их свойства и графики

38.1. а) $y = x^{10}$

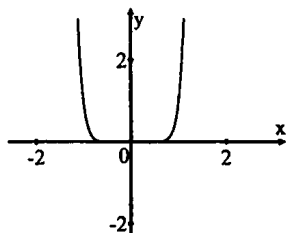

б) $y = x^{\frac{1}{3}}$

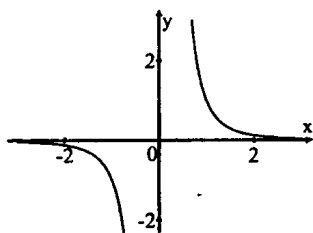

в) $y = x^5$

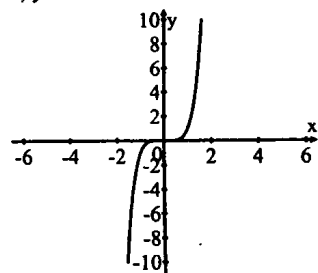

г) $y = x^{-4}$

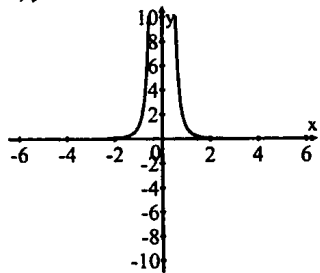

38.2. а) $y = x^{3/2}$

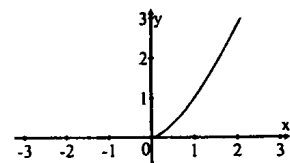

б) $y = x^{1/4}$

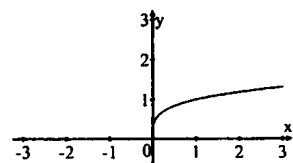

в) $y = x^{-(1/2)}$

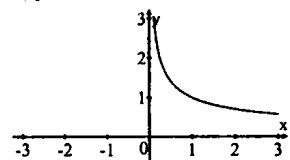

г) $y = x^{5/4}$

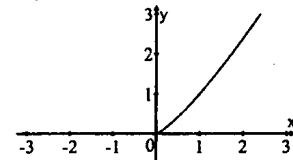

38.3. а) $y = \sqrt[3]{x}$ $y = x^{\frac{1}{3}}$

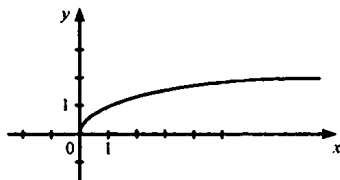
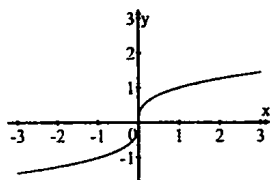

б) $y = \sqrt[4]{x}$ $y = x^{1/4}$

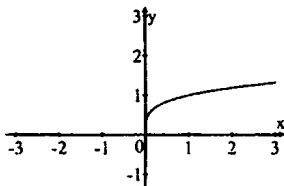
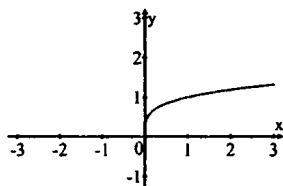

38.4. $f(x) = x^{\frac{5}{2}}$;

а) $f(4) = 32$; б) $f\left(\frac{1}{9}\right) = \frac{1}{243}$; в) $f(0) = 0$; г) $f(0,01) = 0,00001$.

38.5. $f(x) = x^{-\frac{2}{3}}$;

а) $f(1) = 1$; б) $f(8) = \frac{1}{4}$; в) $f\left(\frac{1}{8}\right) = 4$; г) $f(0)$ — не имеет смысла.

38.6. а) $y = x^{10}$; $y(-x) = (-x)^{10} = x^{10} = y(x) \Rightarrow$ четная ;

б) $y = x^{-(1/3)}$; функция определена только для положительных чисел, поэтому не является ни четной, ни нечетной;

в) $y = x^{-15}$; $y(-x) = (-x)^{-15} = -x^{-15} = -y(x) \Rightarrow$ нечетная;

г) $y = x^{\frac{4}{3}}$ — функция определена только для неотрицательных чисел, поэтому не является ни четной, ни нечетной.

38.7. а) $y = x^8$; $y \in [0; +\infty)$. б) $y = x^{-\frac{3}{4}}$; $y \in (0; +\infty)$.

в) $y = x^{-5}$; $y \in \mathbb{R}$ $y \neq 0$. г) $y = x^{\frac{2}{5}}$; $y \in [0; +\infty)$.

38.8. а) $y = x^{12}$; убывает : $(-\infty; 0]$; возрастает : $[0; +\infty)$.

б) $y = x^{-\frac{1}{6}}$; убывает : $(0; +\infty)$.

в) $y = x^{-11}$; убывает на $(-\infty; 0)$ и на $(0; +\infty)$.

г) $y = x^{\frac{1}{7}}$; возрастает на $[0; +\infty)$.

38.9. $y = x^{\frac{1}{4}}$. а) $x \in [0; 1]$; $\max y: \begin{cases} x=1 \\ y=1 \end{cases}$; $\min y: \begin{cases} x=0 \\ y=0 \end{cases}$.

б) $x \in [1; +\infty)$, $\min y: \begin{cases} x=0 \\ y=0 \end{cases}$; $\max y$ не существует.

в) $x \in (2; 3)$; $\min y$ и $\max y$ не существуют.

г) $x \in (5; 16]$; $\max y: \begin{cases} x=16 \\ y=2 \end{cases}$; $\min y$ не существует.

38.10. $y = x^{\frac{5}{2}}$. а) $x \in [0; +\infty)$; $\min y: \begin{cases} x=0 \\ y=0 \end{cases}$; $\max y$ не существует;

б) $x \in [1; 3)$; $\min y: \begin{cases} x=1 \\ y=1 \end{cases}$; $\max y$ не существует;

в) $x \in [1; 2)$; $\min y: \begin{cases} x=1 \\ y=1 \end{cases}$; $\max y$ не существует.

г) $x \in (6; 8]$; $\max y: \begin{cases} x=8 \\ y=128\sqrt{2} \end{cases}$; $\min y$ не существует.

38.11. $y = x^{-\frac{2}{3}}$. а) $x \in [1; 8]$, $\min y = \frac{1}{4}$, $\max y = 1$;

б) $x \in (3; 5)$, $\min y$ и $\max y$ не существуют;

в) $x \in [1; +\infty)$, $\max y = 1$, $\min y$ не существует;

г) $x \in (0; 1]$, $\max y$ не существует, $\min y = 1$.

38.12.

а) $y = (x+2)^{\frac{1}{2}}$ б) $y = x^{7/2} - 3$

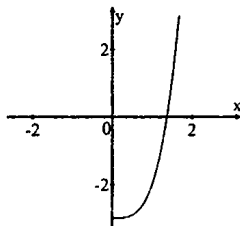
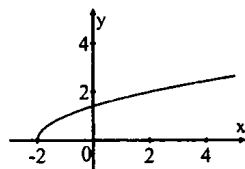

$$b) y = (x - 1)^{-2/3}$$

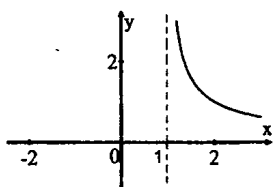

$$r) y = x^{-1/3} + 4$$

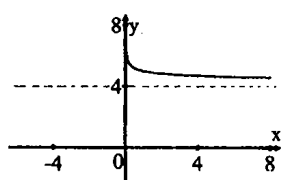

38.13.

$$a) y = (x + 3)^{1/6} - 1$$

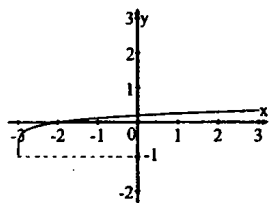

$$b) y = (x - 2)^{-(1/9)} + 5$$

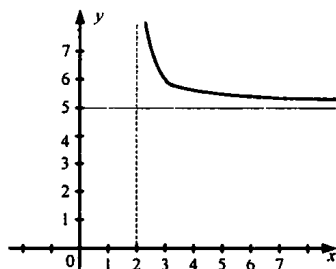

$$b) y = (x + 6)^{7/4} + 2$$

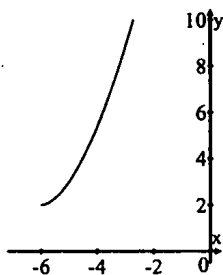

$$r) y = (x - 3)^{1/2} - 1$$

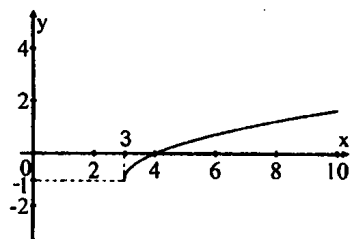

38.14.

$$a) y = 2x^{1/3}$$

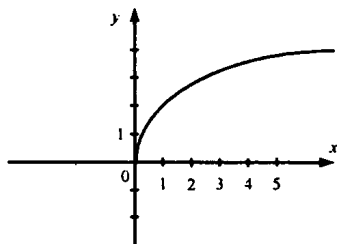

$$b) y = -x^{-(3/5)}$$

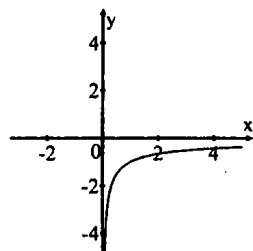

$$b) y = \frac{1}{2}x^{3/2}$$

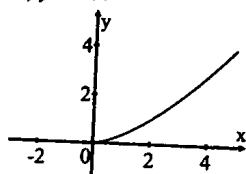

$$38.15. a) x^{\frac{1}{2}} = 6 - x, x = 4;$$

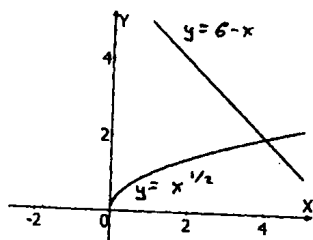

$$b) x^{\frac{1}{4}} = x^{-3}, x = 0, x = 1;$$

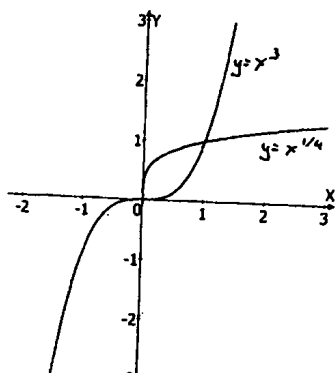

$$38.16. a) \begin{cases} y = x^{\frac{5}{2}} \\ y = 1 \end{cases}; \begin{cases} y = 1 \\ x = 1 \end{cases}$$

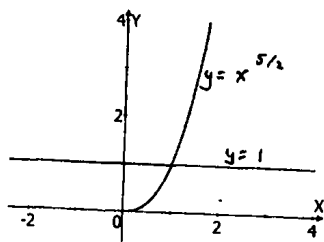

$$r) y = -2x^{1/4}$$

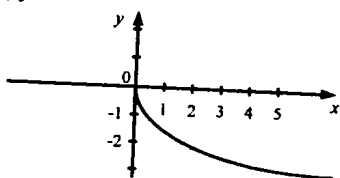

$$b) x^{\frac{3}{2}} = \frac{1}{x^2}, x = 1;$$

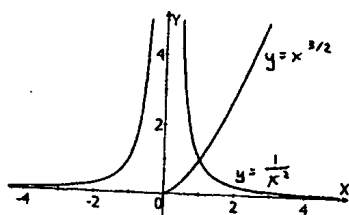

$$r) x^{\frac{2}{3}} = x - 4, x = 8;$$

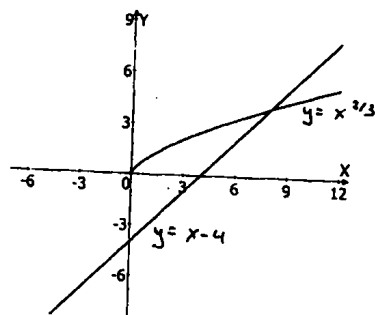

$$b) \begin{cases} y = x^{-\frac{1}{3}} \\ y = \sqrt{x} \end{cases}, \begin{cases} x = 1 \\ y = 1 \end{cases}$$

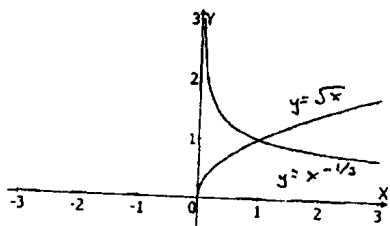

$$b) \begin{cases} y = x^{\frac{1}{6}} \\ y = |x| \end{cases}, \begin{cases} x = 0; 1 \\ y = 0; 1 \end{cases}, (0;0), (1;1);$$

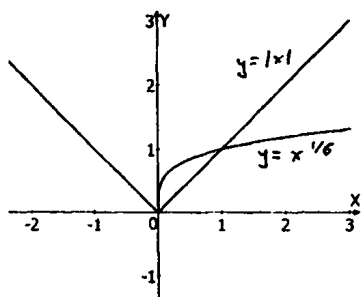

38.17.

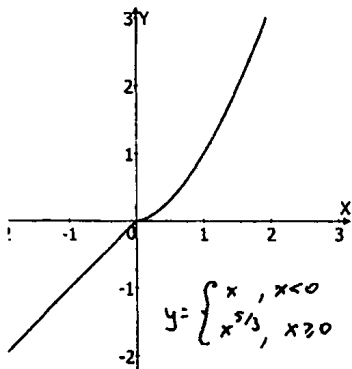

38.19.

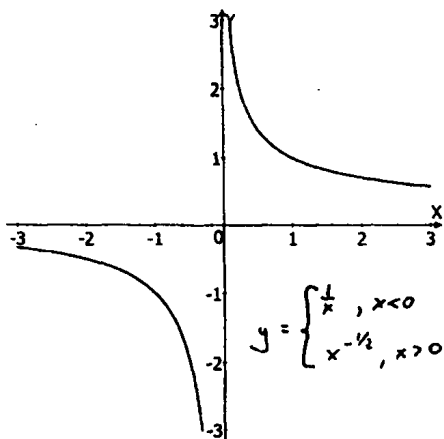

$$r) \begin{cases} y = x^{-\frac{2}{3}} \\ y = 2x - 1 \end{cases}, \begin{cases} x = 1 \\ y = 1 \end{cases};$$

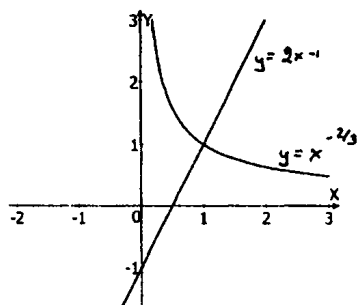

38.18.

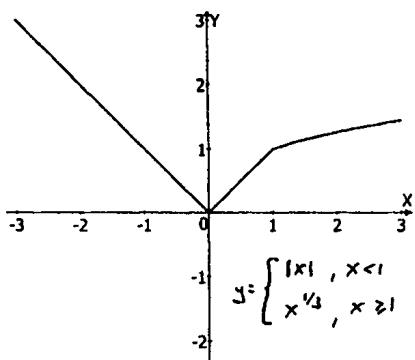

$$38.20. f(x) = x^{\frac{1}{4}}; \text{ a) } f(16x) = (16x)^{\frac{1}{4}} = 2x^{\frac{1}{4}}; \quad \text{б) } f(81x^4) = 3x;$$

$$\text{в) } f\left(\frac{1}{81}x\right) = \left(\frac{x}{81}\right)^{\frac{1}{4}} = \frac{x^{\frac{1}{4}}}{3}; \quad \text{г) } f(x^{-8}) = (x^{-8})^{\frac{1}{4}} = x^{-2}.$$

$$38.21. f(x) = x^{-(2/3)};$$

$$\text{а) } f(8x^3) = (8x^3)^{-\frac{2}{3}} = \frac{1}{4}x^{-2}; \quad \text{б) } f(x^{-6}) = x^4;$$

$$\text{в) } f\left(\frac{x}{27}\right) = \frac{9}{x^{2/3}}; \quad \text{г) } f(x^{12}) = x^{-8}.$$

$$38.22. \text{ а) } y = x^8, y' = 8x^7; \quad \text{б) } y = x^{-4}, y' = -4x^{-5};$$

$$\text{в) } y = x^{40}, y' = 40x^{39}; \quad \text{г) } y = \frac{1}{x^6}, y' = -6x^{-7}.$$

$$38.23. \text{ а) } y = x^{\frac{3}{5}}, y' = \frac{3}{5}x^{-\frac{2}{5}}; \quad \text{б) } y = \sqrt[4]{x^5}, y' = \frac{5}{4}x^{\frac{1}{4}};$$

$$\text{в) } y = x^{\frac{7}{2}}, y' = \frac{7}{2}x^{\frac{5}{2}}; \quad \text{г) } y = \sqrt[5]{x}, y' = \frac{1}{5} \cdot \frac{1}{\sqrt[5]{x^4}}.$$

$$38.24. \text{ а) } y = \frac{1}{\sqrt{x}}, y' = -\frac{1}{2\sqrt{x^3}}; \quad \text{б) } y = \frac{1}{x^{\frac{3}{5}}}, y' = -\frac{3}{5}x^{-\frac{8}{5}};$$

$$\text{в) } y = \frac{1}{\sqrt[3]{x}}, y' = -\frac{1}{3} \cdot \frac{1}{\sqrt[3]{x^4}}; \quad \text{г) } y = \frac{1}{x^{\frac{5}{3}}}, y' = -\frac{5}{3}x^{-\frac{8}{3}};$$

$$38.25. \text{ а) } y = x\sqrt{x}, y' = \frac{3}{2}\sqrt{x}; \quad \text{б) } y = \frac{x^2}{\sqrt{x}}, y' = \frac{3}{2}\sqrt{x};$$

$$\text{в) } y = \frac{\sqrt[3]{x}}{x}, y' = -\frac{2}{3\sqrt[3]{x^5}}; \quad \text{г) } y = x^2 \cdot \sqrt[3]{x}, y' = \frac{7}{3}\sqrt[3]{x^4};$$

$$38.26. \text{ а) } y = 2x^4 + x\sqrt{x}; y' = 8x^3 + \frac{3}{2}\sqrt{x};$$

$$\text{б) } y = \frac{2}{\sqrt[3]{x}} + 3x^6 - 1; y' = -\frac{2}{3\sqrt[3]{x^4}} + 18x^5;$$

$$\text{в) } y = x^5 - \frac{1}{\sqrt{x}}; y' = 5x^4 + \frac{1}{2\sqrt{x^3}};$$

$$r) y = x^3 - 7x\sqrt{x}; y' = 3x^2 - \frac{42}{5}\sqrt{x};$$

$$38.27. a) g(x) = x^3 - 3\sqrt{x}; x_0 = 1; g'(x) = 3x^2 - \frac{3}{2\sqrt{x}}; g'(1) = 3 - \frac{3}{2} = \frac{3}{2};$$

$$b) g(x) = \sqrt[3]{3x-1}; x_0 = \frac{2}{3}; g'(x) = \frac{1}{\sqrt[3]{(3x-1)^2}}; g'\left(\frac{2}{3}\right) = 1;$$

$$в) g(x) = x^{-1} + x^{-2}; x_0 = 1; g'(x) = -x^{-2} - 2x^{-3}; g'(1) = -3;$$

$$r) g(x) = \frac{1}{3}(5-2x)^{-3}; x_0 = 2; g'(x) = 2(5-2x)^{-4}; g'(2) = 2.$$

$$38.28. a) f(x) = 4 - x^{\frac{3}{4}}; x_0 = 1; f'(x) = \frac{3}{4}x^{-\frac{7}{4}}; f'(1) = \frac{3}{4};$$

$$b) f(x) = 12x^{\frac{1}{2}} - x; x_0 = 9; f'(x) = 6x^{-\frac{3}{2}} - 1; f'(9) = -\frac{6}{27} - 1 = -1\frac{2}{9};$$

$$в) f(x) = 2x^{2/3} - 1; x_0 = 8; f'(x) = \frac{4}{3}x^{-(1/3)}; f'(8) = \frac{2}{3};$$

$$r) f(x) = x^{-3} + 6\sqrt{x}; x_0 = 1; f'(x) = -3x^{-4} + \frac{3}{\sqrt{x}}; f'(1) = -3 + 3 = 0.$$

$$38.29. a) g(x) = \frac{2}{3}\sqrt{4-3x}; x_0 = \frac{1}{3};$$

$$g'(x) = -\frac{1}{\sqrt{4-3x}}; g'\left(\frac{1}{3}\right) = -\frac{1}{\sqrt{3}}; \alpha = \frac{5\pi}{6}.$$

$$b) g(x) = -3(\sqrt{2}+x)^{\frac{1}{3}}; x_0 = 1-\sqrt{2}; g'(x) = (\sqrt{2}+x)^{-\frac{4}{3}}; g'(1-\sqrt{2}) = 1; \alpha = \frac{\pi}{4}.$$

$$38.30. a) y = x^4 - 3x^3, a = 2; y = 16 - 24 + (4 \cdot 2^3 - 9 \cdot 2^2)(x-2) = -4x.$$

$$b) y = \sqrt[3]{3x-1}; a = 3; y' = \frac{1}{\sqrt[3]{(3x-1)^2}}; y = 2 + \frac{1}{4}(x-3) = \frac{1}{4}x + \frac{5}{4}.$$

$$в) y = 3x^3 - 5x^2 - 4; a = 2; y' = 9x^2 - 10x; y = 24 - 20 - 4 + 16(x-2) = 16x - 32.$$

$$r) y = (2x+5)^{-\frac{1}{2}}; a = 2; y' = -(2x+5)^{-\frac{3}{2}}; y = \frac{1}{3} - \frac{1}{27}(x-2) = -\frac{1}{27}x + \frac{11}{27}.$$

$$38.31. a) y = \frac{2}{3}x\sqrt{x} - 2x, y' = \sqrt{x} - 2$$

Убывает на $[0, 4]$; возрастает на $[4, +\infty)$. Точка минимума $\left(4; -\frac{8}{3}\right)$.

б) $y = \frac{3}{2}x^{2/3} - x$; $y' = x^{-1/3} - 1$; возрастает на $x \in [0; 1]$;

$x \geq 1$ - убывает; $x = 1$ - max; $y_{\max} = \frac{1}{2}$.

38.32. а) $y = \frac{2}{3}x\sqrt{x} - 2x$, $x \in [1, 9]$ $y' = \sqrt{x} - 2$; $y_{\min} = -\frac{8}{3}$, $y_{\max} = 0$.

б) $y = \frac{3}{2}x^{2/3} - x$; $(0; 8)$; $y' = x^{-(1/3)} - 1$; $y_{\max} = \frac{1}{2}$; min y не существует.

в) $y = \frac{2}{3}x\sqrt{x} - 2x$; $(1; 9)$; $y' = \sqrt{x} - 2$; $x = 4$; $y(4) = \frac{16}{3} - 8 = -\frac{8}{3}$ - min;

y_{\max} не существует.

г) $y = \frac{3}{2}x^{2/3} - x$; $[0; 8]$; $y' = x^{-1/3} - 1$; $y(0) = 0$; $y(8) = -2$; $y(1) = \frac{1}{2}$;

$y_{\max} = \frac{1}{2}$; $y_{\min} = -2$.

38.33.

а)

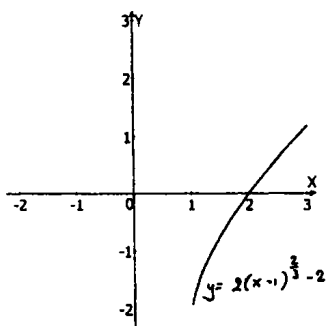

б)

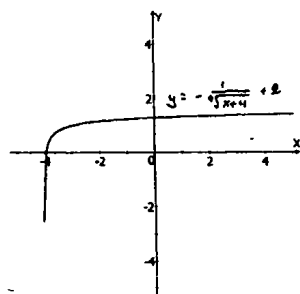

в)

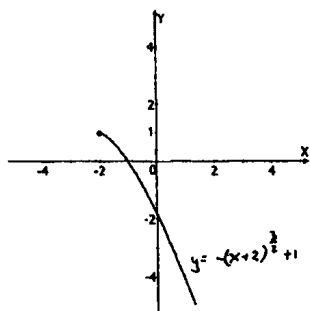

г)

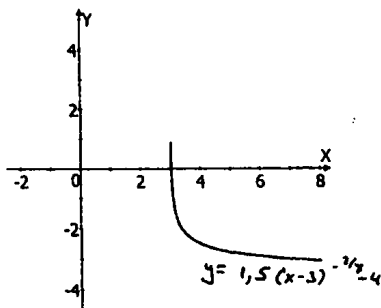

38.34.

а) $x^{\frac{1}{2}} < 6 - x; x \in [0; 4)$.

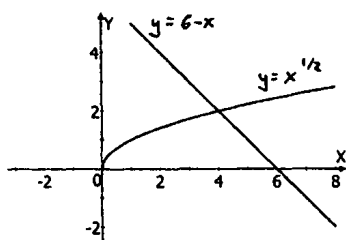

б) $x^{\frac{3}{2}} \geq -2; x \geq 1$.

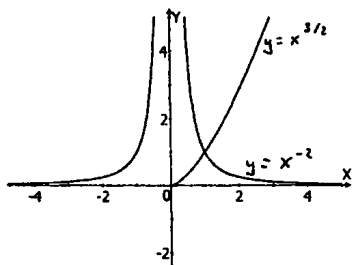

в) $x^{\frac{1}{4}} \leq x^3; x \geq 1$.

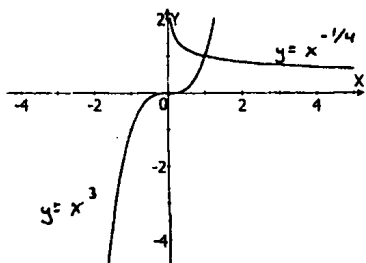

г) $x^{\frac{2}{3}} > x - 4; x \in [0; 8)$.

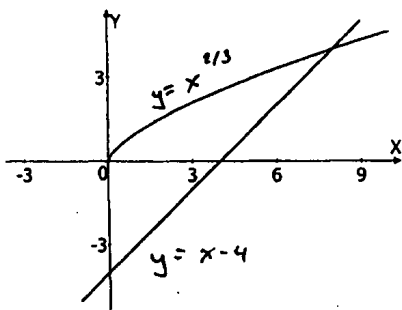

38.35. а) $g(x) = 2\sqrt{x} - x; g'(x) = \frac{1}{\sqrt{x}} - 1 = 0 \quad x = 1$.

б) $g(x) = \frac{2}{3}x^{\frac{3}{2}} - \frac{12}{5}x^{\frac{5}{4}} + 2x; g'(x) = \sqrt{x} - 3\sqrt[4]{x} + 2 = 0;$

$\sqrt[4]{x} = 2; \sqrt[4]{x} = 1; x = 16; x = 1$.

в) $g(x) = \frac{3}{4}x^{\frac{4}{3}} - 2x; g'(x) = x^{\frac{1}{3}} - 2 = 0; x = 8$.

г) $g(x) = \frac{3}{4}x^{\frac{4}{3}} - \frac{6}{7}x^{\frac{7}{6}} - 2x; g'(x) = x^{\frac{1}{3}} - x^{\frac{1}{6}} - 2; x^{\frac{1}{6}} = 2, x^{\frac{1}{6}} = -1;$

 $x = 64$, решений нет.

38.36. а) $f(x) = 4\sqrt[3]{x}; y = x - 2; f'(x) = x^{-\frac{3}{4}}; y = 4\sqrt[3]{x_0} + x_0^{-\frac{3}{4}}(x - x_0);$

$x_0^{-\frac{3}{4}} = 1; x_0 = 1; y = 4 + x - 1 = x + 3$.

$$6) f(x) = \frac{1}{x^3}; y = 5 - 3x; f'(x) = -3\frac{1}{x^4}; y = \frac{1}{x_0^3} - \frac{3}{x_0^4}(x - x_0):$$

$$\frac{3}{x_0^4} = -3; x_0 = \pm 1; y = 1 - 3(x - 1) = -3x + 4; y = -1 - 3(x + 1) = -3x - 4.$$

38.37. a)

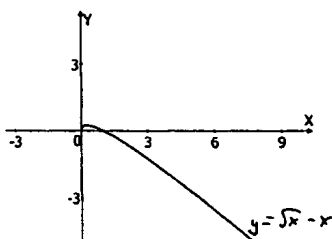

$$y = \sqrt{x} - x; y' = \frac{1}{2\sqrt{x}} - 1 = 0; 2\sqrt{x} = 1, x = \frac{1}{4};$$

возрастает $x \in \left[0; \frac{1}{4}\right]$; убывает $x \geq \frac{1}{4}$; $x = \frac{1}{4}$ — max ww .

б)

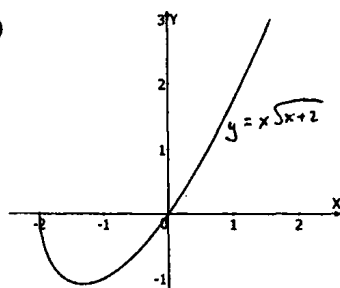

$$y = x\sqrt{x+2}; y' = \sqrt{x+2} + \frac{x}{2\sqrt{x+2}} = \frac{3x+4}{2\sqrt{x+2}} > 0;$$

$x \geq -\frac{4}{3}$ — возрастает; $x \in \left[-2; -\frac{4}{3}\right]$ — убывает; $x = -\frac{4}{3}$ — min.

$$38.38. a) \underbrace{2x^5 + x^3 + 5x - 80}_{y_1} = \underbrace{\sqrt[3]{14 - 3x}}_{y_2};$$

$y_1' = 10x^4 + 3x^2 + 5$ — возрастает, при всех x ;

$y_2' = -\frac{1}{\sqrt[3]{(14 - 3x)^2}}$ — убывает, при всех $x \Rightarrow$ одно решение: $x = 2$.

$$б) \sqrt[4]{10 + 3x} = 74 - x^5 - 3x^3 - 8x; y_1 = \sqrt[4]{10 + 3x};$$

$$y_2 = 74 - x^5 - 3x^3 - 8x; \quad y_1' = \frac{3}{4\sqrt[3]{(10+3x)^3}} - \text{возрастает, при всех } x;$$

$$y_2' = -5x^4 - 9x^2 - 8 - \text{убывает, при всех } x \Rightarrow \text{одно решение: } x = 2.$$

$$38.39. \text{ а) } y = \sqrt{x} \quad M(0;1); \quad y' = \frac{1}{2\sqrt{x}}; \quad y = \sqrt{x_0} + \frac{1}{2\sqrt{x_0}}(x - x_0);$$

$$1 = \sqrt{x_0} + \frac{1}{2\sqrt{x_0}}(-x_0); \quad 1 = \sqrt{x_0} - \frac{1}{2}\sqrt{x_0}; \quad \frac{1}{2}\sqrt{x_0} = 1; \quad x_0 = 4;$$

$$y = 2 + \frac{1}{4}(x - 4); \quad y = \frac{1}{4}x + 1.$$

$$\text{б) } y = x^{\frac{3}{2}} + 4; \quad M(0;0); \quad y' = \frac{3}{2}\sqrt{x}; \quad y = x_0^{\frac{3}{2}} + 4 + \frac{3}{2}\sqrt{x_0}(x - x_0);$$

$$0 = x_0^{\frac{3}{2}} + 4 + \frac{3}{2}\sqrt{x_0}(-x_0); \quad x_0^{\frac{3}{2}} = 8; \quad x_0 = 4; \quad y = 8 + 4 + \frac{3}{2} \cdot 2(x - 4);$$

$$y = 3x - 12 + 12; \quad y = 3x.$$

Учебно-методическое издание

Сапожников Андрей Александрович

**Домашняя работа
по алгебре и началам
математического анализа
за 10 класс**

Издательство «**ЭКЗАМЕН**»

Гигиенический сертификат
№ 77.99.60.953.Д.000454.01.09 от 27.01.2009 г.

Выпускающий редактор *Л.Д. Лаппо*
Дизайн обложки *И.Р. Захаркина*
Компьютерная верстка *Е.Ю. Лысова*

105066, Москва, ул. Нижняя Красносельская, д. 35, стр. 1.
www.examen.biz

E-mail: по общим вопросам: info@examen.biz;
по вопросам реализации: sale@examen.biz
тел./факс 641-00-30 (многоканальный)

Общероссийский классификатор продукции
ОК 005-93, том 2; 953005 — книги, брошюры, литература учебная

Текст отпечатан с диапозитивов
в ОАО «Владимирская книжная типография»
600000, г. Владимир, Октябрьский проспект, д. 7
Качество печати соответствует
качеству предоставленных диапозитивов

По вопросам реализации обращаться по тел.:
641-00-30 (многоканальный).